

# SIEMENS

Siemens s.r.o.,

Lamačská cesta 3/A

841 04 Bratislava, Slovak Republic

<http://www.siemens.sk>

Investor	Odvoz a likvidácia odpadu a.s.	
Stavba	Riadenie roštu kotla č.+20	
Objekt, PS		
Číslo kontraktu		
Archívne číslo		
Číslo zákazky	P.02091.01	
Sieť		
Napájanie		
Ovládacie napätie 1.		
Ovládacie napätie 2.		
Ovládacie napätie 3.		
Ochrana pred nebezpečným dotykom: do 1000V/AC a 1500V/DC	Základná	
	Zvýšená	
Dátum:	12. 2. 2016	Kreslil : Tomáš Sivok
		Kontroloval: Began

			Vypracoval Tomáš Sivok	Zákazník: Odvoz a likvidácia odpadu a.s.	<b>SIEMENS</b> SIEMENS s.r.o. ,Lamačská cesta 3/A 841 04 Bratislava - SK	=	REV: 6/2016 PSV
			Kontroloval Began				
Revízia	Dátum	Meno	Datum	6/2016	=	+	List 1
1	2	3	4	5			

# Obsah

Sloupec X: Automaticky generovaná stránka byla dodatečně ručně upravena

F06\_001

Stránka	Popis stránek	Doplňkové pole stránky	Datum	Zpracoval	X
/1			8. 6. 2016	z003k8fn	
/2	Obsah : /1 - +20BPE01/35		8. 6. 2016	z003k8fn	
/2.a	Obsah : +20BPE01/36 - +20CBB01/72		8. 6. 2016	z003k8fn	
/2.b	Obsah : +20CBB01/73 - +20CBC02/114		8. 6. 2016	z003k8fn	
/2.c	Obsah : +20CBC02/115 - +20CBD01/151		8. 6. 2016	z003k8fn	
/4	Topológia Profinet siete		8. 6. 2016	z003k8fn	
+20CDG01/1	Napájanie 230V AC	Rozvádzač/ Riadenie rošta	8. 6. 2016	z003k8fn	
+20CDG01/2	Zásuvky 230V	Rozvádzač/ Riadenie rošta	8. 6. 2016	z003k8fn	
+20CDG01/3	Rezerva	Rozvádzač/ Riadenie rošta	8. 6. 2016	z003k8fn	
+20CDG01/4	Rezerva	Rozvádzač/ Riadenie rošta	8. 6. 2016	z003k8fn	
+20CDG01/5	Napájanie 24V DC	Rozvádzač/ Riadenie rošta	8. 6. 2016	z003k8fn	
+20CDG01/6	DÍ karta 1-4	Rozvádzač/ Riadenie rošta	8. 6. 2016	z003k8fn	
+20CDG01/7	DÍ karta 5-8	Rozvádzač/ Riadenie rošta	8. 6. 2016	z003k8fn	
+20BPE01/15	Napájanie 230V AC	FU Rozvádzač / Pohony kúrenia	8. 6. 2016	z003k8fn	
+20BPE01/16	Hydraulická pumpa / Podávač 1	FU Rozvádzač / Pohony kúrenia	8. 6. 2016	z003k8fn	
+20BPE01/17	Hydraulická pumpa / Podávač 2	FU Rozvádzač / Pohony kúrenia	8. 6. 2016	z003k8fn	
+20BPE01/18	Hydraulická pumpa / Rošt 1	FU Rozvádzač / Pohony kúrenia	8. 6. 2016	z003k8fn	
+20BPE01/19	Hydraulická pumpa / Rošt 2	FU Rozvádzač / Pohony kúrenia	8. 6. 2016	z003k8fn	
+20BPE01/20	Hydraulická pumpa / Odškvárovač	FU Rozvádzač / Pohony kúrenia	8. 6. 2016	z003k8fn	
+20BPE01/21	Vykurovací motor hydrauliky	FU Rozvádzač / Pohony kúrenia	8. 6. 2016	z003k8fn	
+20BPE01/22	Pumpa mastenia tukom	FU Rozvádzač / Pohony kúrenia	8. 6. 2016	z003k8fn	
+20BPE01/24	Ventilátor Chladiaceho vzduchu	FU Rozvádzač / Pohony kúrenia	8. 6. 2016	z003k8fn	
+20BPE01/25	Sledovanie podpatia	FU Rozvádzač / Pohony kúrenia	8. 6. 2016	z003k8fn	
+20BPE01/26	Ventilátor rozvádzača	FU Rozvádzač / Pohony kúrenia	8. 6. 2016	z003k8fn	
+20BPE01/27	Rezerva	FU Rozvádzač / Pohony kúrenia	8. 6. 2016	z003k8fn	
+20BPE01/28	Núdzové vypnutie a ochrana kotla	FU Rozvádzač / Pohony kúrenia	8. 6. 2016	z003k8fn	
+20BPE01/29	Hydraulika - pretlaková pumpa 1	FU Rozvádzač / Pohony kúrenia	8. 6. 2016	z003k8fn	
+20BPE01/30	Hydraulika - pretlaková pumpa 2	FU Rozvádzač / Pohony kúrenia	8. 6. 2016	z003k8fn	
+20BPE01/31	Rezerva	FU Rozvádzač / Pohony kúrenia	8. 6. 2016	z003k8fn	
+20BPE01/32	Napájanie 24V DC	FU Rozvádzač / Pohony kúrenia	8. 6. 2016	z003k8fn	
+20BPE01/33	DÍ karta 1-4	FU Rozvádzač / Pohony kúrenia	8. 6. 2016	z003k8fn	
+20BPE01/34	DÍ karta 5-8	FU Rozvádzač / Pohony kúrenia	8. 6. 2016	z003k8fn	
+20BPE01/35	4DO karta	FU Rozvádzač / Pohony kúrenia	8. 6. 2016	z003k8fn	

			Vypracoval Tomáš Sivok	Zákazník: Základka: Odvoz a likvidácia odpadu a.s. <b>Riadenie rošta</b>	<b>SIEMENS</b> SIEMENS s.r.o. „Lamačská cesta 3/A 841 04 Bratislava - SK			=	
			Kontroloval Began			REV: 6/2016 PSV			+
			Schválil Began			Arch. číslo: P.02091.01			List 2
Revízia	Dátum	Meno	Datum	6/2016		<b>Obsah : /1 - +20BPE01/35</b>		Listov 6	

# Obsah

Sloupec X: Automaticky generovaná stránka byla dodatečně ručně upravena

F06\_001

Stránka	Popis stránek	Doplňkové pole stránky	Datum	Zpracoval	X
+20BPE01/36	4DO karta	FU Rozvádzač / Pohony kúrenia	8. 6. 2016	z003k8fn	
+20BPE01/37	DI karta 1-4	FU Rozvádzač / Pohony kúrenia	8. 6. 2016	z003k8fn	
+20BPE01/38	DI karta 5-8	FU Rozvádzač / Pohony kúrenia	8. 6. 2016	z003k8fn	
+20BPE01/39	4DO karta	FU Rozvádzač / Pohony kúrenia	8. 6. 2016	z003k8fn	
+20BPE01/40	4DO karta	FU Rozvádzač / Pohony kúrenia	8. 6. 2016	z003k8fn	
+20BPE01/41	4DO karta	FU Rozvádzač / Pohony kúrenia	8. 6. 2016	z003k8fn	
+20BPE01/42	4DO karta	FU Rozvádzač / Pohony kúrenia	8. 6. 2016	z003k8fn	
+20BPE01/43	AI karta	FU Rozvádzač / Pohony kúrenia	8. 6. 2016	z003k8fn	
+20BPE01/44	AI karta	FU Rozvádzač / Pohony kúrenia	8. 6. 2016	z003k8fn	
+20BPE01/45	AO karta	FU Rozvádzač / Pohony kúrenia	8. 6. 2016	z003k8fn	
+20BPE01/46	AO karta	FU Rozvádzač / Pohony kúrenia	8. 6. 2016	z003k8fn	
+20CBA01/41	Rozvádzač / Hydraulická pumpová stanica	Hydr. pumpová stanica	8. 6. 2016	z003k8fn	
+20CBA01/42	DI karta 1-4	Hydr. pumpová stanica	8. 6. 2016	z003k8fn	
+20CBA01/43	DI karta 5-8	Hydr. pumpová stanica	8. 6. 2016	z003k8fn	
+20CBA01/44	AI karta	Hydr. pumpová stanica	8. 6. 2016	z003k8fn	
+20CDF01/46	Napájanie 230V AC/24V DC	Rozvádzač/ Pomocné prístroje	8. 6. 2016	z003k8fn	
+20CDF01/47	DI karta 1-4	Rozvádzač/ Pomocné prístroje	8. 6. 2016	z003k8fn	
+20CDF01/48	DI karta 5-8	Rozvádzač/ Pomocné prístroje	8. 6. 2016	z003k8fn	
+20CDF01/49	4DO karta	Rozvádzač/ Pomocné prístroje	8. 6. 2016	z003k8fn	
+20CDF01/50	4DO karta	Rozvádzač/ Pomocné prístroje	8. 6. 2016	z003k8fn	
+20CDF01/51	4DO karta	Rozvádzač/ Pomocné prístroje	8. 6. 2016	z003k8fn	
+20CDF01/55	4DO-R karta	Rozvádzač/ Pomocné prístroje	8. 6. 2016	z003k8fn	
+20CDF01/56	4DO-R karta	Rozvádzač/ Pomocné prístroje	8. 6. 2016	z003k8fn	
+20CDF01/57	4DO-R karta	Rozvádzač/ Pomocné prístroje	8. 6. 2016	z003k8fn	
+20CDF01/60	4DO-R karta	Rozvádzač/ Pomocné prístroje	8. 6. 2016	z003k8fn	
+20CFE01/63	Napájanie 24V DC	Rozvádzač/ Tlak v pásmoch rošta	8. 6. 2016	z003k8fn	
+20CFE01/64	AI karta	Rozvádzač/ Tlak v pásmoch rošta	8. 6. 2016	z003k8fn	
+20CFE01/65	Tlak do Telepermu	Rozvádzač/ Tlak v pásmoch rošta	8. 6. 2016	z003k8fn	
+20CFE02/66	Napájanie 24V DC	Rozvádzač/ Tlak v pásmoch rošta	8. 6. 2016	z003k8fn	
+20CFE02/67	AI karta	Rozvádzač/ Tlak v pásmoch rošta	8. 6. 2016	z003k8fn	
+20CBB01/68	Napájanie 230V AC/24V DC	Rozvádzač / Roštová dráha 1	8. 6. 2016	z003k8fn	
+20CBB01/71	4DO karta	Rozvádzač / Roštová dráha 1	8. 6. 2016	z003k8fn	
+20CBB01/72	4DO karta	Rozvádzač / Roštová dráha 1	8. 6. 2016	z003k8fn	

© Copyright SIEMENS s.r.o. 2015

Revízia	Dátum	Meno	Vypracoval	Tomáš Sivok
			Kontroloval	Began
			Schválil	Began
			Datum	6/2016

Zákazník:	Odvoz a likvidácia odpadu a.s.
Zákazka:	<b>Riadenie rošta</b>

**SIEMENS**  
SIEMENS s.r.o. „Lamačská cesta 3/A  
841 04 Bratislava - SK

REV: 6/2016 PSV		=
Arch. číslo: P.02091.01		+
<b>Obsah : +20BPE01/36 - +20CBB01/72</b>		List 2.a
		Listov 6

# Obsah

Sloupec X: Automaticky generovaná stránka byla dodatečně ručně upravena

F06\_001

Stránka	Popis stránek	Doplňkové pole stránky	Datum	Zpracoval	X
+20CBB01/73	DI karta 1-4	Rozvádzač / Roštová dráha 1	8. 6. 2016	z003k8fn	
+20CBB01/74	DI karta 5-8	Rozvádzač / Roštová dráha 1	8. 6. 2016	z003k8fn	
+20CBB01/75	DI karta 1-4	Rozvádzač / Roštová dráha 1	8. 6. 2016	z003k8fn	
+20CBB01/76	DI karta 5-8	Rozvádzač / Roštová dráha 1	8. 6. 2016	z003k8fn	
+20CBB01/77	DI karta 1-4	Rozvádzač / Roštová dráha 1	8. 6. 2016	z003k8fn	
+20CBB01/78	DI karta 5-8	Rozvádzač / Roštová dráha 1	8. 6. 2016	z003k8fn	
+20CBB01/79	DI karta 1-4	Rozvádzač / Roštová dráha 1	8. 6. 2016	z003k8fn	
+20CBB01/80	DI karta 5-8	Rozvádzač / Roštová dráha 1	8. 6. 2016	z003k8fn	
+20CBB01/81	AI karta	Rozvádzač / Roštová dráha 1	8. 6. 2016	z003k8fn	
+20CBB02/82	Napájanie 230V AC/24V DC	Rozvádzač / Roštová dráha 2	8. 6. 2016	z003k8fn	
+20CBB02/85	4DO karta	Rozvádzač / Roštová dráha 2	8. 6. 2016	z003k8fn	
+20CBB02/86	4DO karta	Rozvádzač / Roštová dráha 2	8. 6. 2016	z003k8fn	
+20CBB02/87	DI karta 1-4	Rozvádzač / Roštová dráha 2	8. 6. 2016	z003k8fn	
+20CBB02/88	DI karta 5-8	Rozvádzač / Roštová dráha 2	8. 6. 2016	z003k8fn	
+20CBB02/89	DI karta 1-4	Rozvádzač / Roštová dráha 2	8. 6. 2016	z003k8fn	
+20CBB02/90	DI karta 5-8	Rozvádzač / Roštová dráha 2	8. 6. 2016	z003k8fn	
+20CBB02/91	DI karta 1-4	Rozvádzač / Roštová dráha 2	8. 6. 2016	z003k8fn	
+20CBB02/92	DI karta 5-8	Rozvádzač / Roštová dráha 2	8. 6. 2016	z003k8fn	
+20CBB02/93	DI karta 1-4	Rozvádzač / Roštová dráha 2	8. 6. 2016	z003k8fn	
+20CBB02/94	DI karta 5-8	Rozvádzač / Roštová dráha 2	8. 6. 2016	z003k8fn	
+20CBB02/95	AI karta	Rozvádzač / Roštová dráha 2	8. 6. 2016	z003k8fn	
+20CBC01/96	Napájanie 230V AC/24V DC	Rozvádzač / Zklz odpadu a sek. Vzduchu	8. 6. 2016	z003k8fn	
+20CBC01/97	DI karta 1-4	Rozvádzač / Zklz odpadu a sek. Vzduchu	8. 6. 2016	z003k8fn	
+20CBC01/98	DI karta 5-8	Rozvádzač / Zklz odpadu a sek. Vzduchu	8. 6. 2016	z003k8fn	
+20CBC01/104	AI karta	Rozvádzač / Zklz odpadu a sek. Vzduchu	8. 6. 2016	z003k8fn	
+20CBC01/106	AI karta	Rozvádzač / Zklz odpadu a sek. Vzduchu	8. 6. 2016	z003k8fn	
+20CBC02/108	Napájanie 230V AC/24V DC	Rozvádzač / Škvárový valec a odškvarovač	8. 6. 2016	z003k8fn	
+20CBC02/109	DI karta 1-4	Rozvádzač / Škvárový valec a odškvarovač	8. 6. 2016	z003k8fn	
+20CBC02/110	DI karta 5-8	Rozvádzač / Škvárový valec a odškvarovač	8. 6. 2016	z003k8fn	
+20CBC02/111	4DO karta	Rozvádzač / Škvárový valec a odškvarovač	8. 6. 2016	z003k8fn	
+20CBC02/112	4DO karta	Rozvádzač / Škvárový valec a odškvarovač	8. 6. 2016	z003k8fn	
+20CBC02/113	DI karta 1-4	Rozvádzač / Škvárový valec a odškvarovač	8. 6. 2016	z003k8fn	
+20CBC02/114	DI karta 5-8	Rozvádzač / Škvárový valec a odškvarovač	8. 6. 2016	z003k8fn	

Revízia	Dátum	Meno	Vypracoval Tomáš Sivok	Zákazník: Odvoz a likvidácia odpadu a.s.	<b>SIEMENS</b> SIEMENS s.r.o. „Lamačská cesta 3/A 841 04 Bratislava - SK	<b>Obsah : +20CBB01/73 - +20CBC02/114</b>	P.02091.01	Listov 6		
			Kontroloval Began	Zákazka: <b>Riadenie rošta</b>					REV: 6/2016 PSV	=
			Schválil Began						Arch. číslo:	+
			Datum 6/2016					List 2.b		

# Obsah

Sloupec X: Automaticky generovaná stránka byla dodatečně ručně upravena

F06\_001

Stránka	Popis stránek	Doplňkové pole stránky	Datum	Zpracoval	X
+20CBC02/115	DI karta 1-4	Rozvádzač / Škvárový valec a odškvarovač	8. 6. 2016	z003k8fn	
+20CBC02/116	DI karta 5-8	Rozvádzač / Škvárový valec a odškvarovač	8. 6. 2016	z003k8fn	
+20BPD01/130	Napájanie 230V AC	FU Rozvádzač / SNCR	8. 6. 2016	z003k8fn	
+20BPD01/131	NH4OH Dávkovacia pumpa 1	FU Rozvádzač / SNCR	8. 6. 2016	z003k8fn	
+20BPD01/132	NH4OH Dávkovacia pumpa 2	FU Rozvádzač / SNCR	8. 6. 2016	z003k8fn	
+20BPD01/134	Sledovanie podpatia	FU Rozvádzač / SNCR	8. 6. 2016	z003k8fn	
+20BPD01/135	Ventilátor rozvádzača	FU Rozvádzač / SNCR	8. 6. 2016	z003k8fn	
+20BPD01/136	Rezerva	FU Rozvádzač / SNCR	8. 6. 2016	z003k8fn	
+20BPD01/137	Napájanie 24V DC	FU Rozvádzač / SNCR	8. 6. 2016	z003k8fn	
+20BPD01/138	DI karta 1-4	FU Rozvádzač / SNCR	8. 6. 2016	z003k8fn	
+20BPD01/139	DI karta 5-8	FU Rozvádzač / SNCR	8. 6. 2016	z003k8fn	
+20BPD01/140	4DO karta	FU Rozvádzač / SNCR	8. 6. 2016	z003k8fn	
+20BPD01/141	4DO karta	FU Rozvádzač / SNCR	8. 6. 2016	z003k8fn	
+20BPD01/142	DI karta 1-4	FU Rozvádzač / SNCR	8. 6. 2016	z003k8fn	
+20BPD01/143	DI karta 5-8	FU Rozvádzač / SNCR	8. 6. 2016	z003k8fn	
+20BPD01/144	AI karta	FU Rozvádzač / SNCR	8. 6. 2016	z003k8fn	
+20BPD01/145	AO karta	FU Rozvádzač / SNCR	8. 6. 2016	z003k8fn	
+20CBD01/144	Napájanie 24V DC	Rozvádzač SNCR	8. 6. 2016	z003k8fn	
+20CBD01/145	DI karta 1-4	Rozvádzač SNCR	8. 6. 2016	z003k8fn	
+20CBD01/146	DI karta 5-8	Rozvádzač SNCR	8. 6. 2016	z003k8fn	
+20CBD01/147	4DO karta	Rozvádzač SNCR	8. 6. 2016	z003k8fn	
+20CBD01/148	4DO karta	Rozvádzač SNCR	8. 6. 2016	z003k8fn	
+20CBD01/149	AI karta	Rozvádzač SNCR	8. 6. 2016	z003k8fn	
+20CBD01/150	DI karta 1-4	Rozvádzač SNCR	8. 6. 2016	z003k8fn	
+20CBD01/151	DI karta 5-8	Rozvádzač SNCR	8. 6. 2016	z003k8fn	

© Copyright SIEMENS s.r.o. 2015

			Vypracoval Tomáš Sivok	Zákazník: Odvoz a likvidácia odpadu a.s.		<b>SIEMENS</b> SIEMENS s.r.o. „Lamačská cesta 3/A 841 04 Bratislava - SK	REV: 6/2016 PSV		=
			Kontroloval Began	Zákazka: <b>Riadenie rošta</b>			Arch. číslo: P.02091.01		+
Revízia	Dátum	Meno	Datum				Obsah : +20CBC02/115 - +20CBD01/151		List 2.c
1	2	3	6/2016				P.02091.01		Listov 6

© Copyright SIEMENS s.r.o. 2015

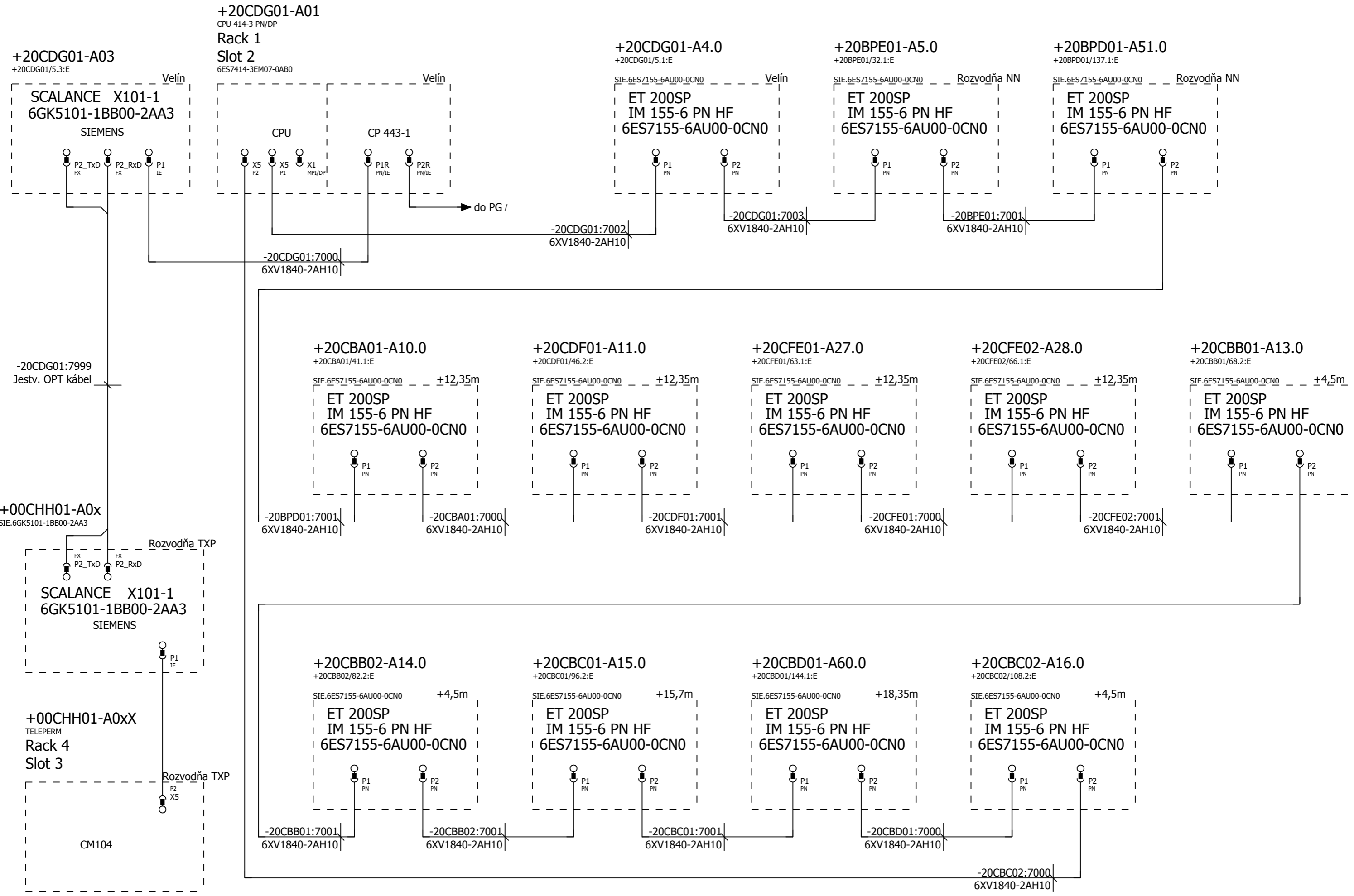

Vypracoval Tomáš Sivok		Zákazník: Odvoz a likvidácia odpadu a.s.		<b>SIEMENS</b> SIEMENS s.r.o. „Lamačská cesta 3/A 841 04 Bratislava - SK		Riadenie rošta		=		
Kontroloval Began		Zákazka: Riadenie rošta				REV: 6/2016 PSV		+		
Schválil Began				Arch. číslo: P.02091.01		List 4				
Revízia	Dátum	Meno	Datum	6/2016	<b>Topológia Profinet siete</b>		Listov 6			

© Copyright SIEMENS s.r.o. 2015

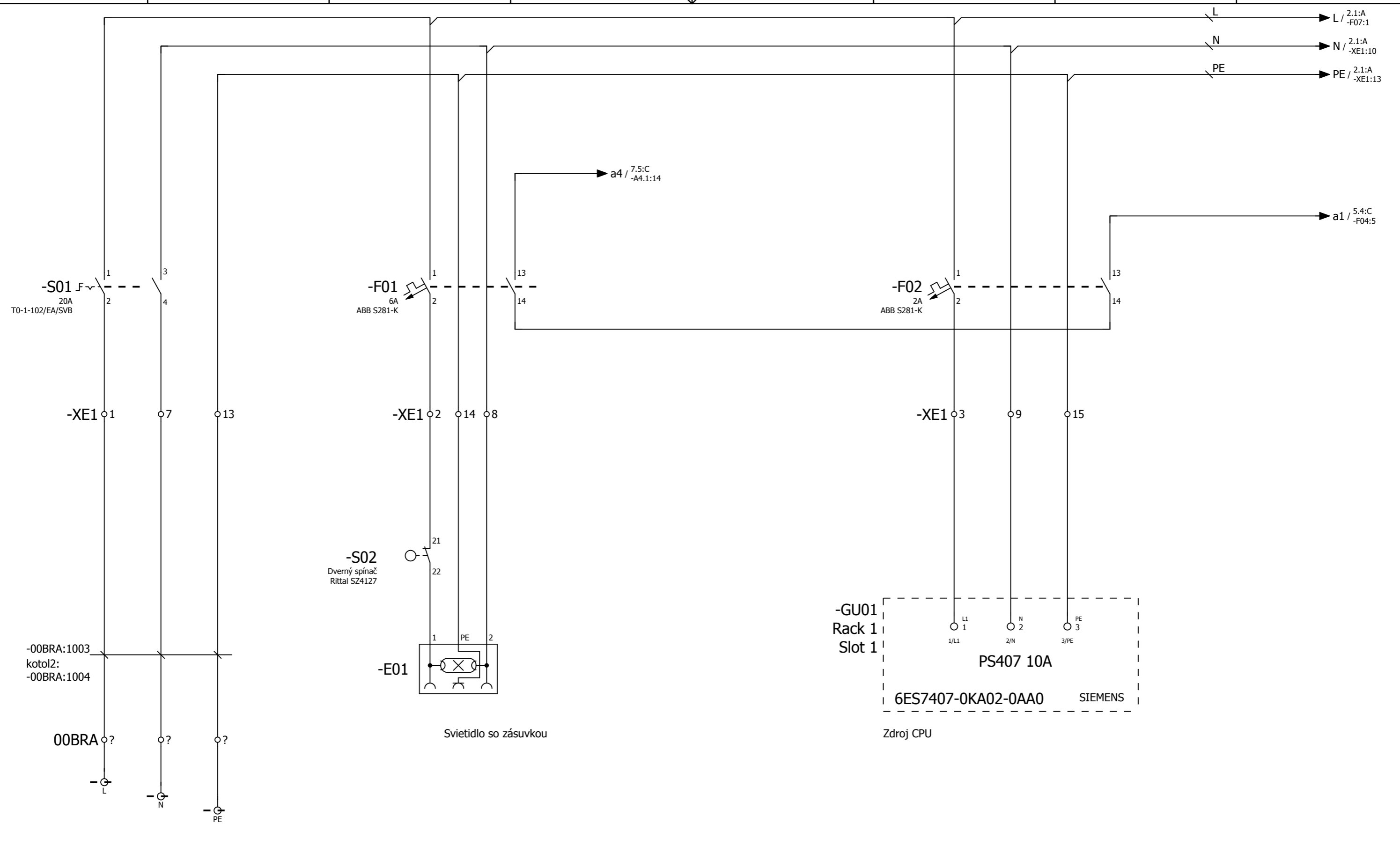

1+NPE 230VAC 50Hz / TN-S

Svietidlo so zásuvkou

Zdroj CPU

			Vypracoval Tomáš Sivok Kontroloval Began Schválil Began Datum 6/2016	Zákazník: Odvoz a likvidácia odpadu a.s. Zákazka: Riadenie rošta	<b>SIEMENS</b> SIEMENS s.r.o. , Lamačská cesta 3/A 841 04 Bratislava - SK	<b>Rozvádzač/ Riadenie rošta</b>  <b>Napájanie 230V AC</b>	REV: 6/2016 PSV Arch. číslo: P.02091.01	= +20CDG01 List 1 Listov 7
1	2	3	4	5	6	7	8	

© Copyright SIEMENS s.r.o. 2015

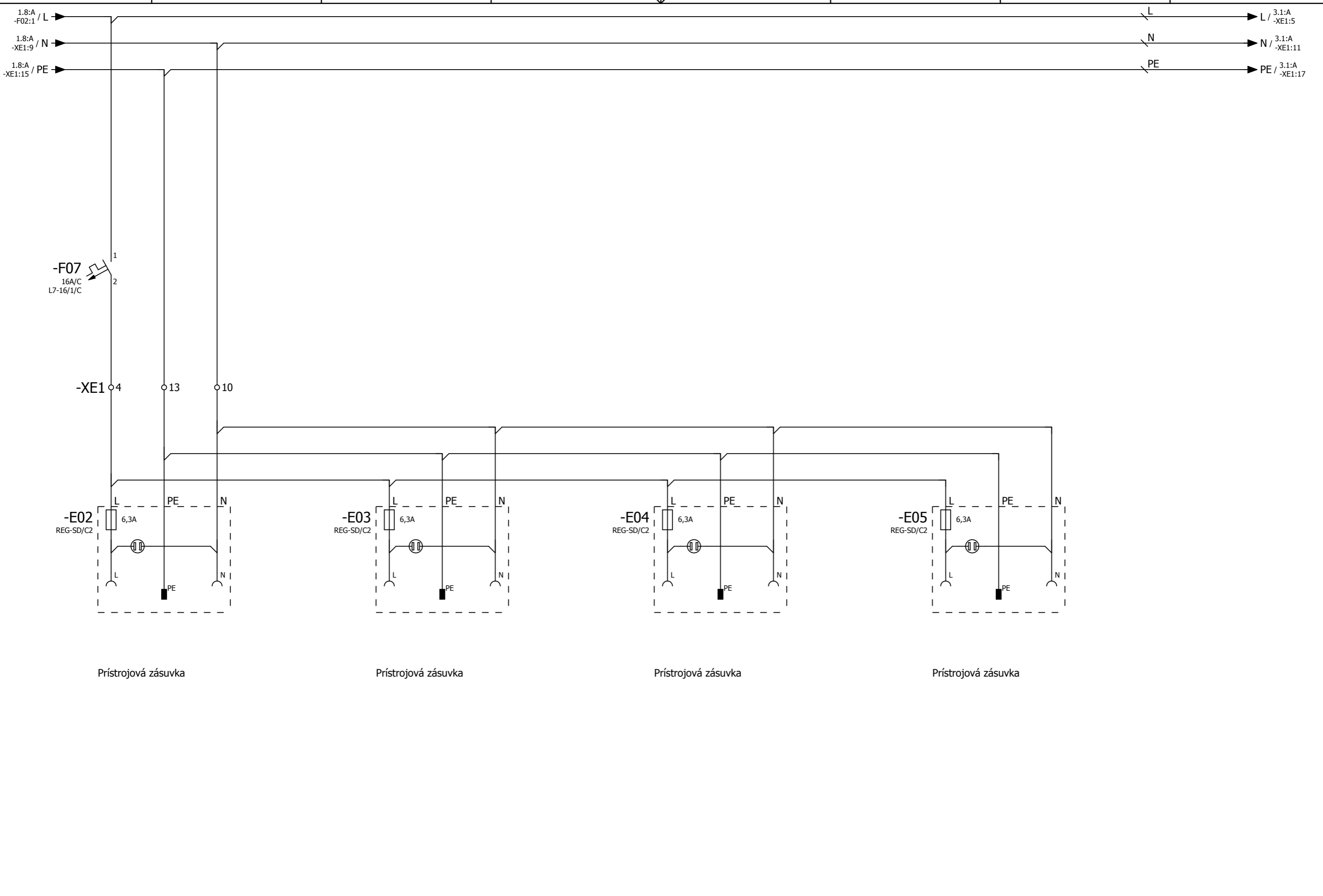

			Vypracoval Tomáš Sivok Kontroloval Began Schválil Began Datum 6/2016	Zákazník: Odvoz a likvidácia odpadu a.s. Zákazka: Riadenie rošta	<b>SIEMENS</b> SIEMENS s.r.o., Lamačská cesta 3/A 841 04 Bratislava - SK	<b>Rozvádzač/ Riadenie rošta</b>  <b>Zásuvky 230V</b>	= +20CDG01 List 2 Listov 7
Revízia	Dátum	Meno	Datum				REV: 6/2016 PSV Arch. číslo: P.02091.01
1							



© Copyright SIEMENS s.r.o. 2015



Rezerva

			Vypracoval Tomáš Sivok Kontroloval Began Schválil Began	Zákazník: Odvoz a likvidácia odpadu a.s. Zákazka: <b>Riadenie rošta</b>	<b>SIEMENS</b> SIEMENS s.r.o. „Lamačská cesta 3/A“ 841 04 Bratislava - SK	<b>Rozvádzač/ Riadenie rošta</b>  <b>Rezerva</b>	= REV: 6/2016 PSV Arch. číslo: P.02091.01	+20CDG01 List 3 Listov 7
Revízia	Dátum	Meno	Datum	6/2016				

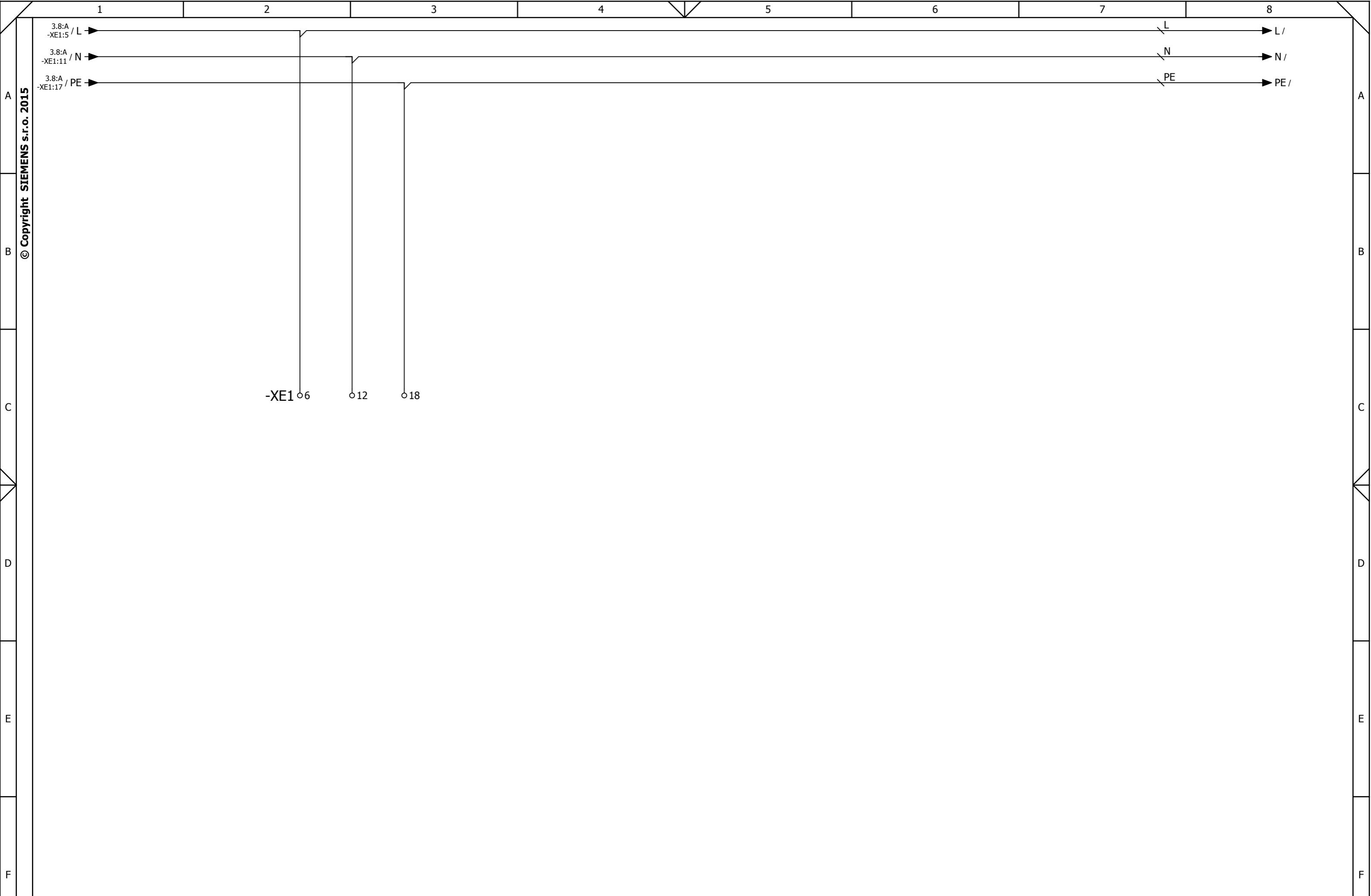

© Copyright SIEMENS s.r.o. 2015

			Vypracoval Tomáš Sivok Kontroloval Began Schválil Began	Zákazník: Odvoz a likvidácia odpadu a.s. Zákazka: <b>Riadenie rošta</b>	<b>SIEMENS</b> SIEMENS s.r.o. „Lamačská cesta 3/A“ 841 04 Bratislava - SK	<b>Rozvádzač/ Riadenie rošta</b>  <b>Rezerva</b>	= REV: 6/2016 PSV Arch. číslo: P.02091.01	+20CDG01 List 4 Listov 7
Revizia	Dátum	Meno	Datum	6/2016				

© Copyright SIEMENS s.r.o. 2015

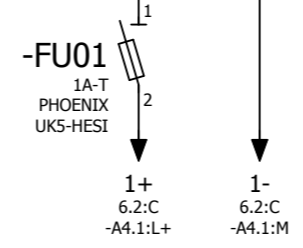
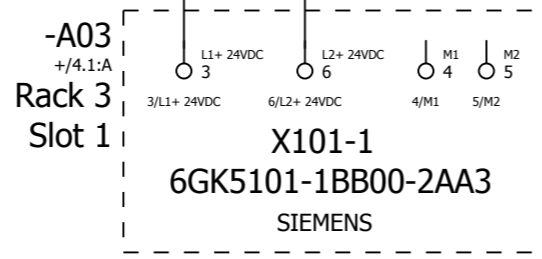
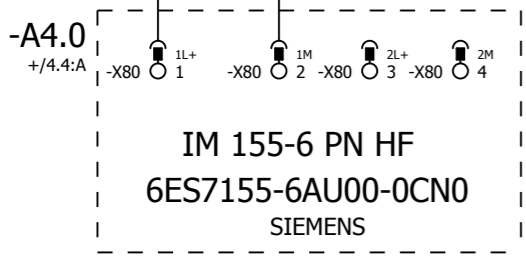
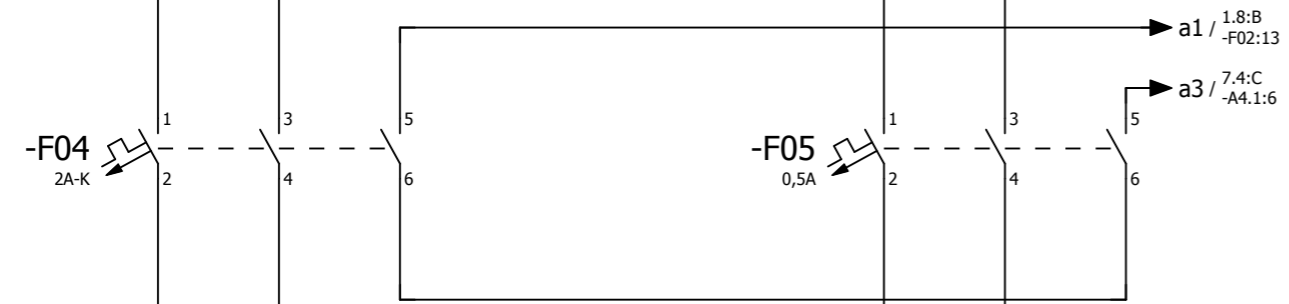
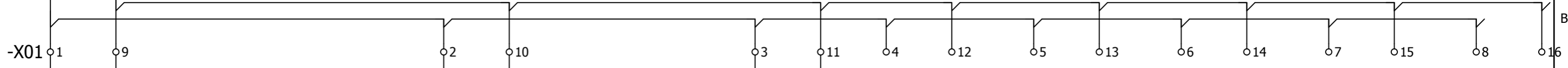
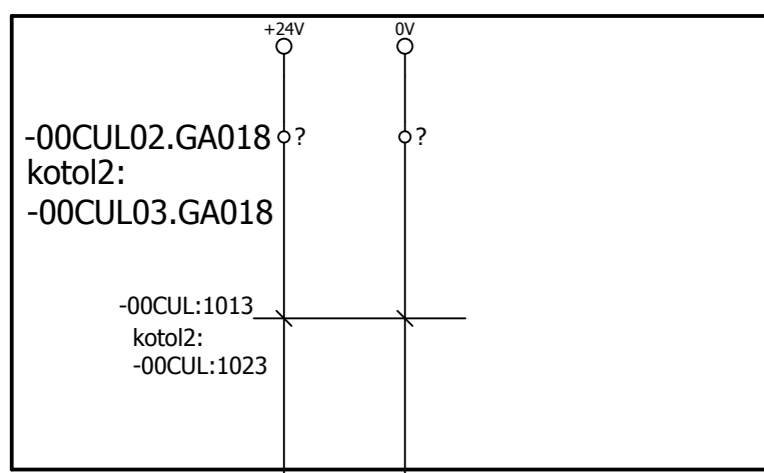

Opto/ETH prevodník

Revizia	Dátum	Meno	Vypracoval Tomáš Sivok
			Kontroloval Began
			Schválil Began
			Datum 6/2016

Zákazník: Odvoz a likvidácia odpadu a.s.  
Zákazka: Riadenie rošta

**SIEMENS**  
SIEMENS s.r.o. „Lamačská cesta 3/A  
841 04 Bratislava - SK

**Rozvádzač/ Riadenie rošta**  
**Napájanie 24V DC**

REV: 6/2016 PSV	=
Arch. číslo: P.02091.01	+20CDG01
	List 5
	Listov 7

-A4.1  
/7.1:A  
Rack X  
Slot Y

6ES7131-6BF00-0BA0 + BU15-P16+A10+2D DI 8x24 VDC ST

SIEMENS

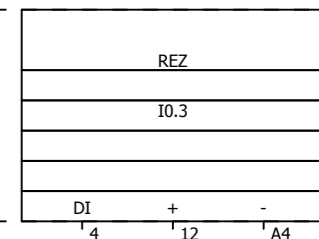
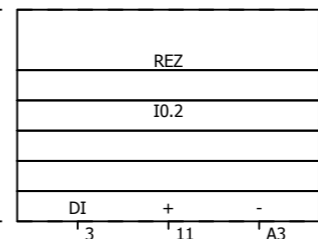
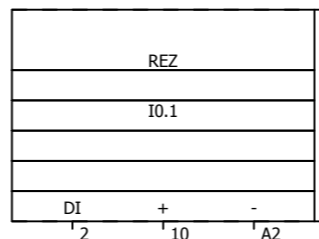
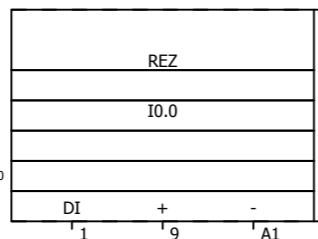
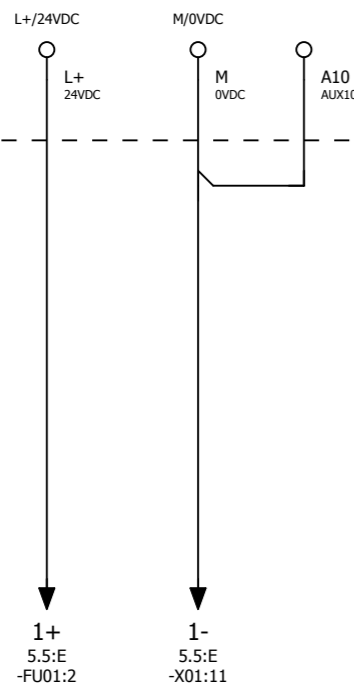

© Copyright SIEMENS s.r.o. 2015

Revizia	Dátum	Meno	Datum	6/2016

Zákazník:	Odvoz a likvidácia odpadu a.s.
Zákazka:	Riadenie rošta

**SIEMENS**  
SIEMENS s.r.o. ,Lamačská cesta 3/A  
841 04 Bratislava - SK

**Rozvádzač/ Riadenie rošta**  
  
**DI karta 1-4**

REV: 6/2016 PSV		+20CDG01
Arch. číslo: P.02091.01		List 6
		Listov 7

-A4.1  
/6.1:A  
Rack X  
Slot Y

6ES7131-6BF00-0BA0 + BU15-P16+A10+2D DI 8x24 VDC ST

SIEMENS

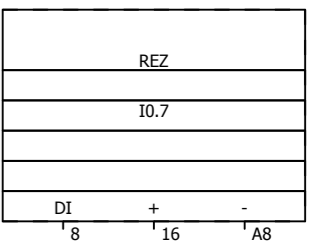
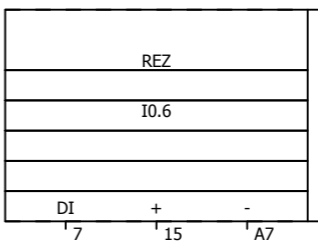
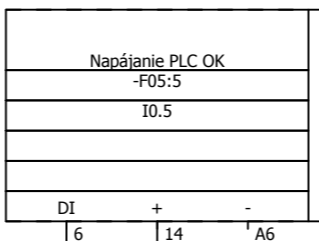
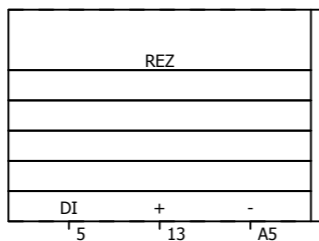

a3

5.4:C  
-F05:5

a4

1.4:B  
-F01:13

© Copyright SIEMENS s.r.o. 2015

			Vypracoval Tomáš Sivok	Zákazník: Odvoz a likvidácia odpadu a.s.
			Kontroloval Began	Zákazka: Riadenie rošta
			Schválil Began	
Revízia	Dátum	Meno	Datum	6/2016

1	2	3	4	5	6	7	8
---	---	---	---	---	---	---	---

**SIEMENS**  
SIEMENS s.r.o. „Lamačská cesta 3/A  
841 04 Bratislava - SK

**Rozvádzač/ Riadenie rošta**  
  
**DI karta 5-8**

=	
REV: 6/2016 PSV	+20CDG01
Arch. číslo: P.02091.01	List 7
	Listov 7

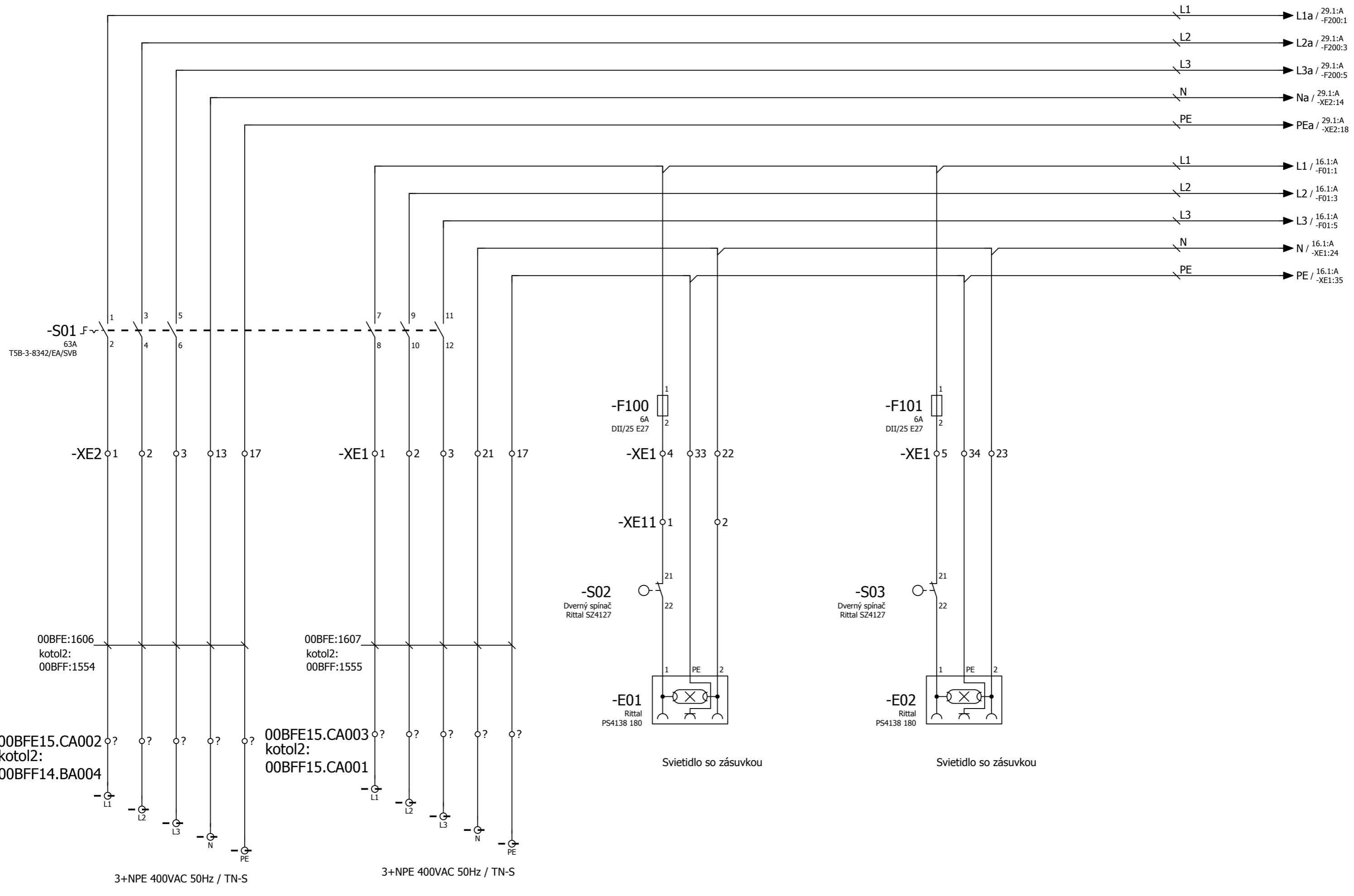

Revizia	Dátum	Meno	Datum
		Schválil	6/2016
		Kontroloval	
		Tomáš Sivok	

Zákazník:	Odvoz a likvidácia odpadu a.s.
Zákazka:	Riadenie rošta

**SIEMENS**  
SIEMENS s.r.o. „Lamačská cesta 3/A  
841 04 Bratislava - SK

**FU Rozvádzač / Pohony kúrenia**  
**Napájanie 230V AC**

REV: 6/2016 PSV	=
Arch. číslo: P.02091.01	+20BPE01
	List 15
	Listov 31

© Copyright SIEMENS s.r.o. 2015

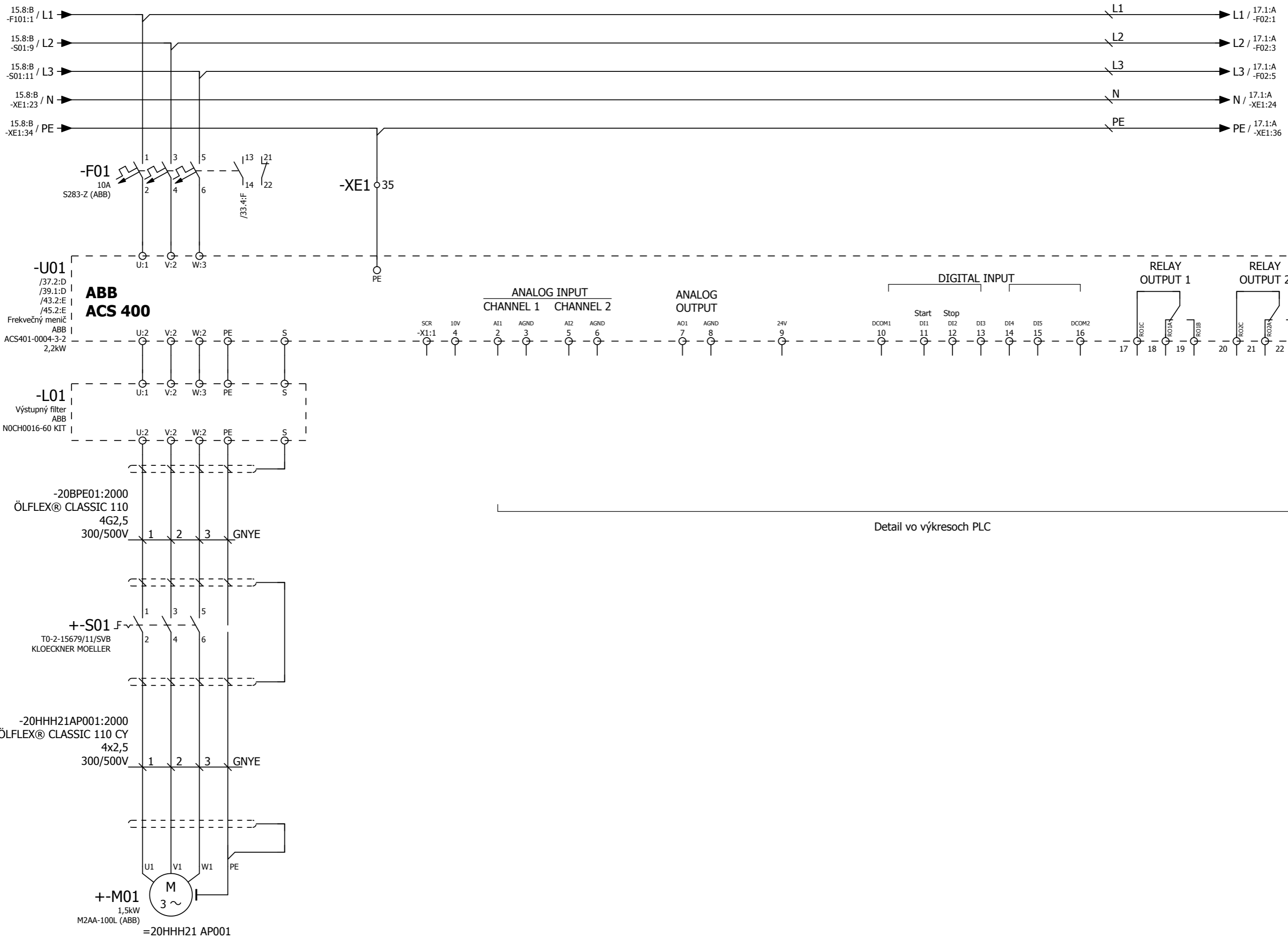

Detail vo výkresoch PLC

Revízia	Dátum	Meno	Datum
1			6/2016

Vypracoval Tomáš Sivok Kontroloval Began Schválil Began	Zákazník: Odvoz a likvidácia odpadu a.s. Zákazka: Riadenie rošta
---	---

**SIEMENS**  
 SIEMENS s.r.o., Lamačská cesta 3/A  
 841 04 Bratislava - SK

**FU Rozvádzač / Pohony kúrenia**  
**Hydraulická pumpa / Podávač 1**

REV: 6/2016 PSV	D1 =	+20BPE01
Arch. číslo: P.02091.01		
	List	16
	Listov	31

© Copyright SIEMENS s.r.o. 2015

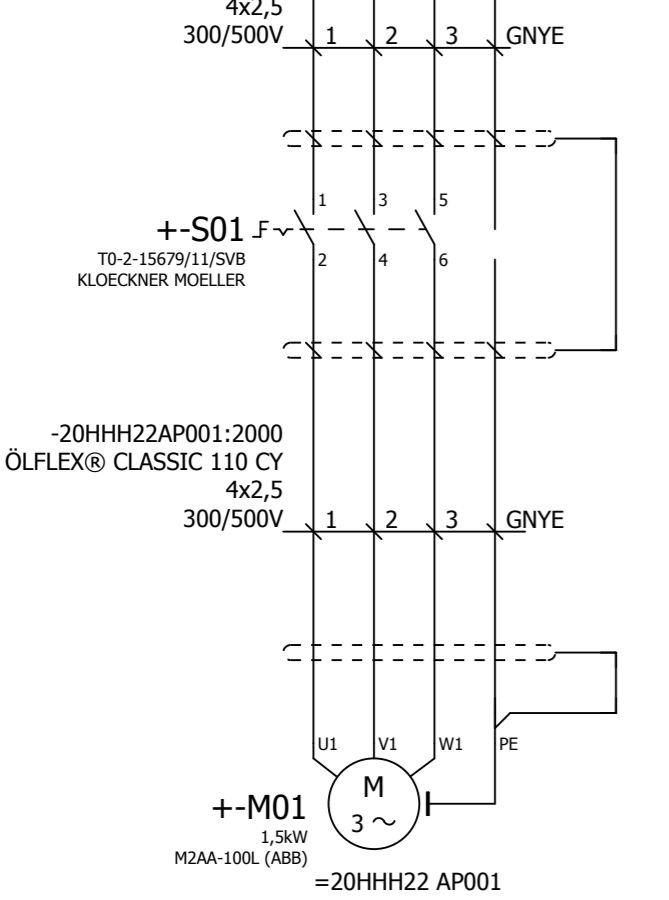
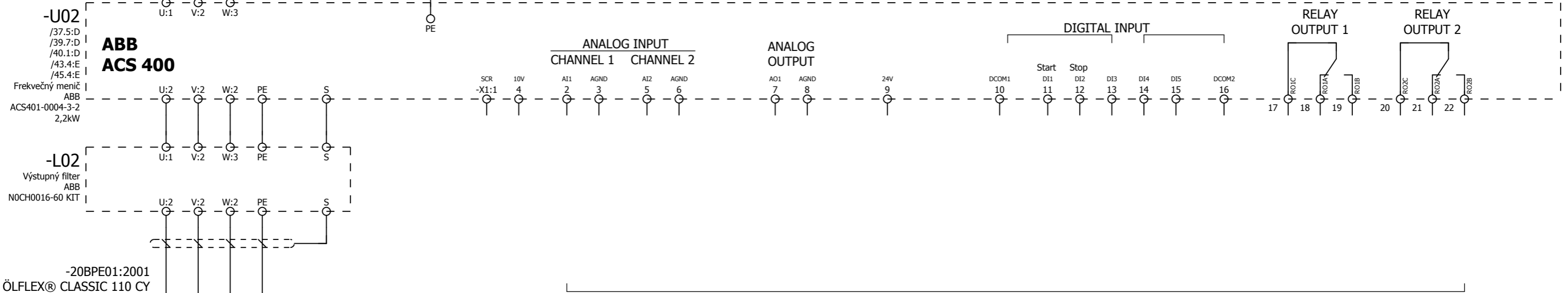
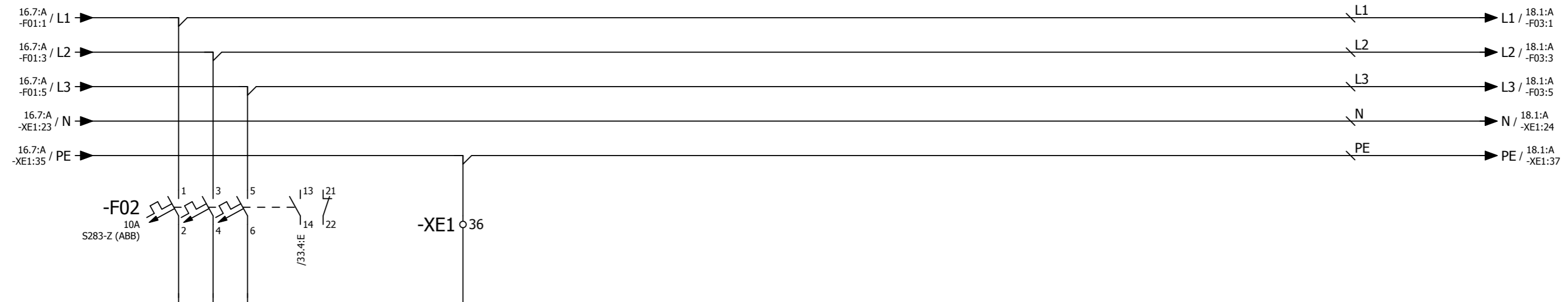

Detail vo výkresoch PLC

Revizia	Dátum	Meno	Datum
			6/2016

Vypracoval Tomáš Sivok Kontroloval Began Schválil Began	Zákazník: Odvoz a likvidácia odpadu a.s. Zákazka: Riadenie rošta
---	---

**SIEMENS**  
 SIEMENS s.r.o. , Lamačská cesta 3/A  
 841 04 Bratislava - SK

**FU Rozvádzač / Pohony kúrenia**  
  
**Hydraulická pumpa / Podávač 2**

REV: 6/2016 PSV	D1 =	+20BPE01
Arch. číslo: P.02091.01		
	List	17
	Listov	31



© Copyright SIEMENS s.r.o. 2015

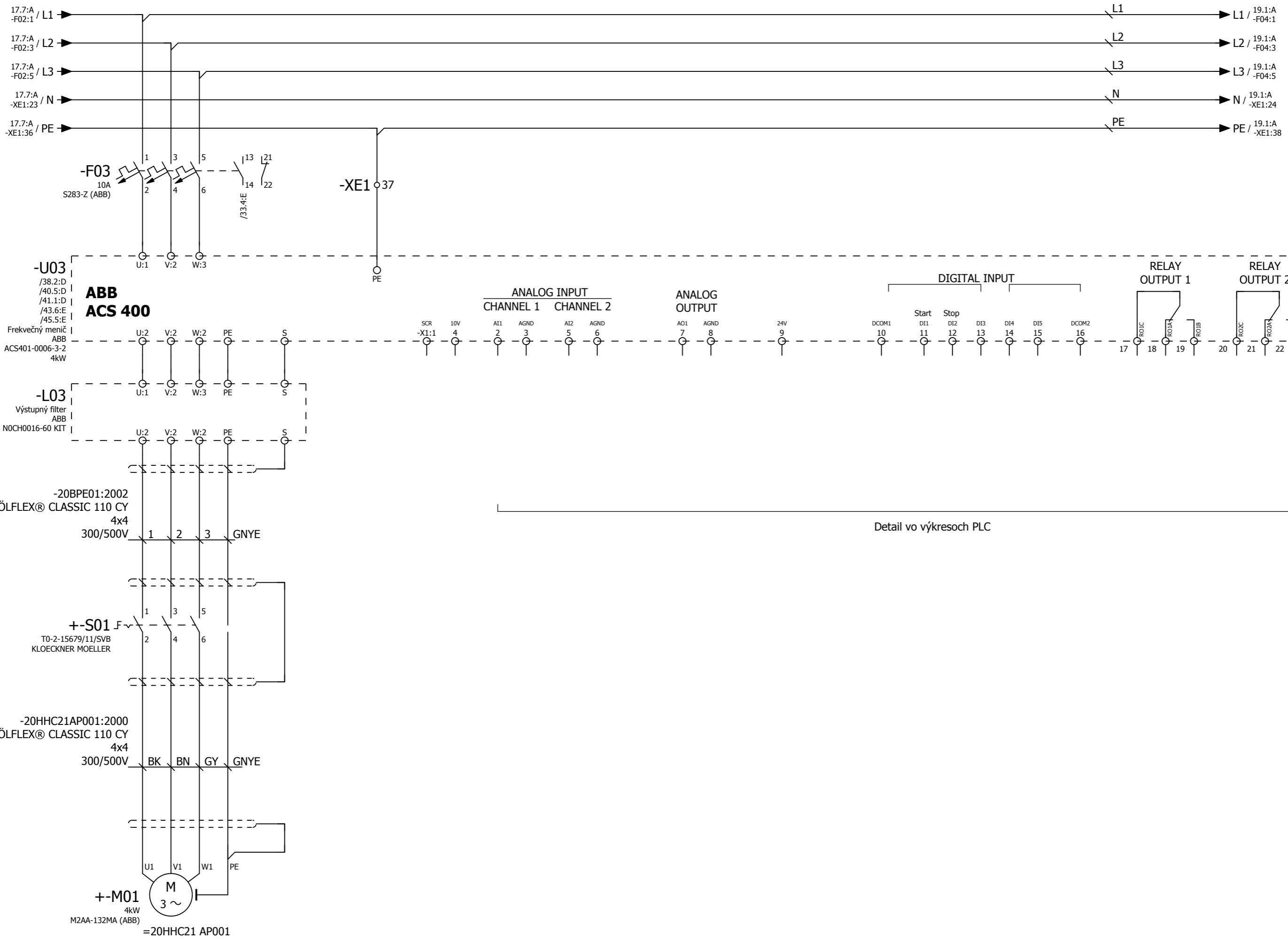

Detail vo výkresoch PLC

Revízia	Dátum	Meno	Datum
			6/2016

Vypracoval: Tomáš Sivok Kontroloval: Began Schválil: Began	Zákazník: Odvoz a likvidácia odpadu a.s. Zákazka: Riadenie rošta
--	---

**SIEMENS**  
 SIEMENS s.r.o., Lamačská cesta 3/A  
 841 04 Bratislava - SK

**FU Rozvádzač / Pohony kúrenia**  
  
**Hydraulická pumpa / Rošt 1**

REV: 6/2016 PSV	D1 =	+20BPE01
Arch. číslo: P.02091.01		
	List	18
	Listov	31

© Copyright SIEMENS s.r.o. 2015

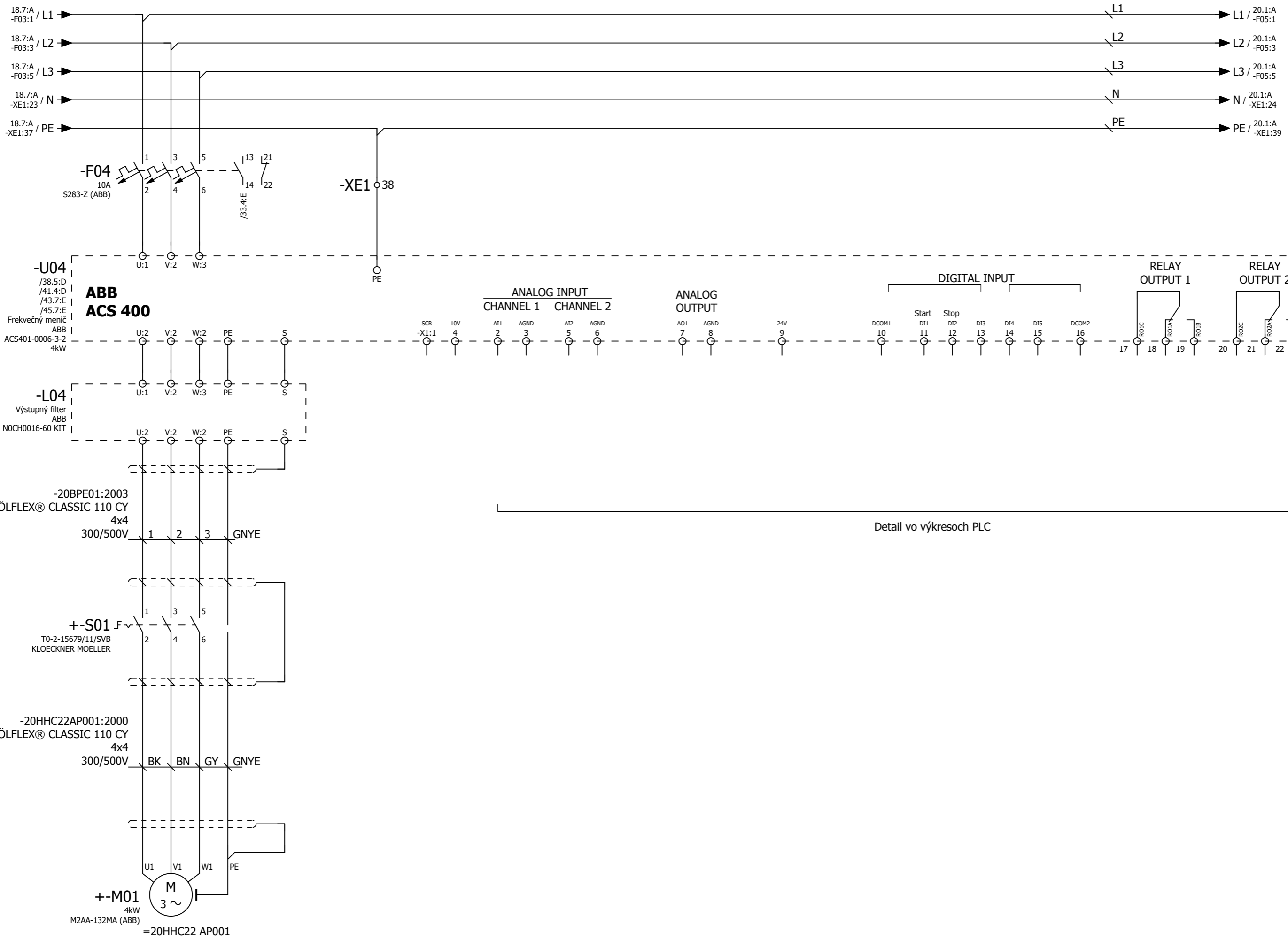

Detail vo výkresoch PLC

			Vypracoval Tomáš Sivok
			Kontroloval Began
			Schválil Began
Revizia	Dátum	Meno	Datum 6/2016

Zákazník: Odvoz a likvidácia odpadu a.s.
Zákazka: Riadenie rošta

**SIEMENS**  
SIEMENS s.r.o. , Lamačská cesta 3/A  
841 04 Bratislava - SK

**FU Rozvádzač / Pohony kúrenia**  
**Hydraulická pumpa / Rošt 2**

REV: 6/2016 PSV	D1 =	+20BPE01
Arch. číslo: P.02091.01		List 19
		Listov 31

© Copyright SIEMENS s.r.o. 2015

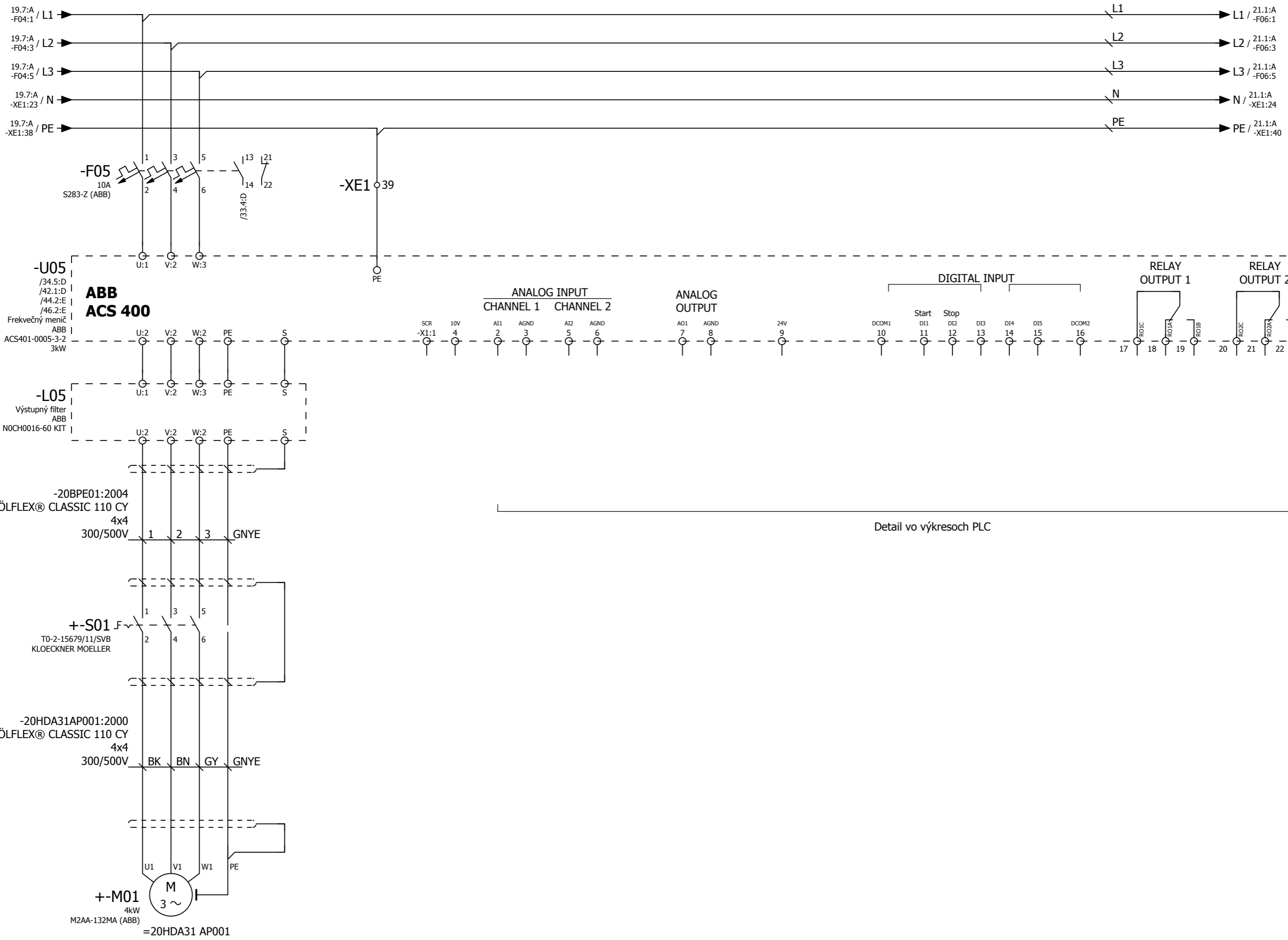

Detail vo výkresoch PLC

Revízia	Dátum	Meno	Datum
			6/2016

Vypracoval Tomáš Sivok Kontroloval Began Schválil Began	Zákazník: Odvoz a likvidácia odpadu a.s. Zákazka: Riadenie rošta
---	---

**SIEMENS**  
 SIEMENS s.r.o., Lamačská cesta 3/A  
 841 04 Bratislava - SK

**FU Rozvádzač / Pohony kúrenia**  
**Hydraulická pumpa / Odškvárovač**

REV: 6/2016 PSV	D1 =	+20BP01
Arch. číslo: P.02091.01		
	List	20
	Listov	31

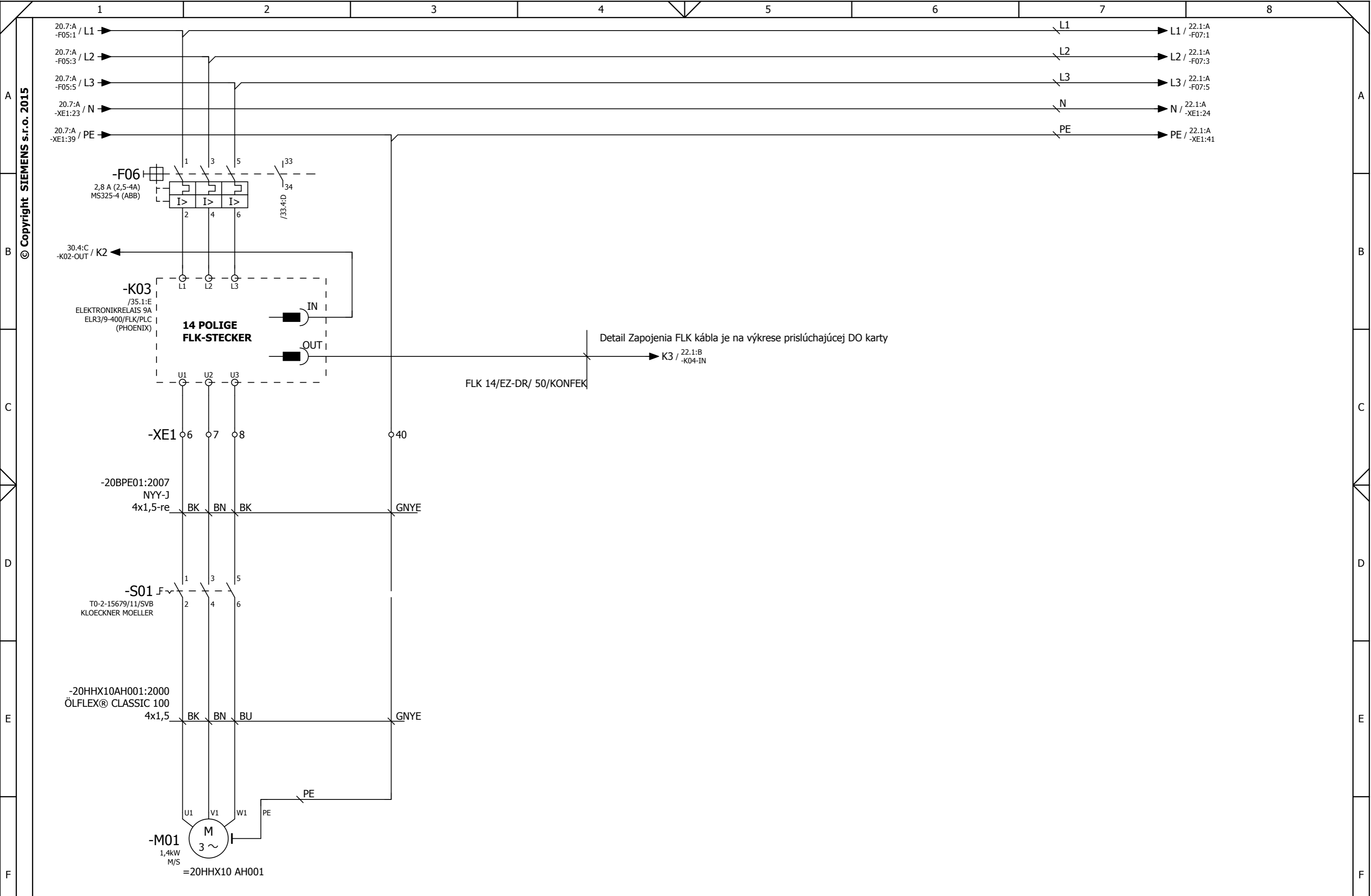

			Vypracoval Tomáš Sivok
			Kontroloval Began
			Schválil Began
Revizia	Dátum	Meno	Datum 6/2016

Zákazník: Odvoz a likvidácia odpadu a.s.
Zákazka: Riadenie rošta

**SIEMENS**  
SIEMENS s.r.o. „Lamačská cesta 3/A  
841 04 Bratislava - SK

**FU Rozvádzač / Pohony kúrenia**  
**Vykurovací motor hydrauliky**

REV: 6/2016 PSV	D1 =	+20BPE01
Arch. číslo: P.02091.01		List 21
		Listov 31

© Copyright SIEMENS s.r.o. 2015

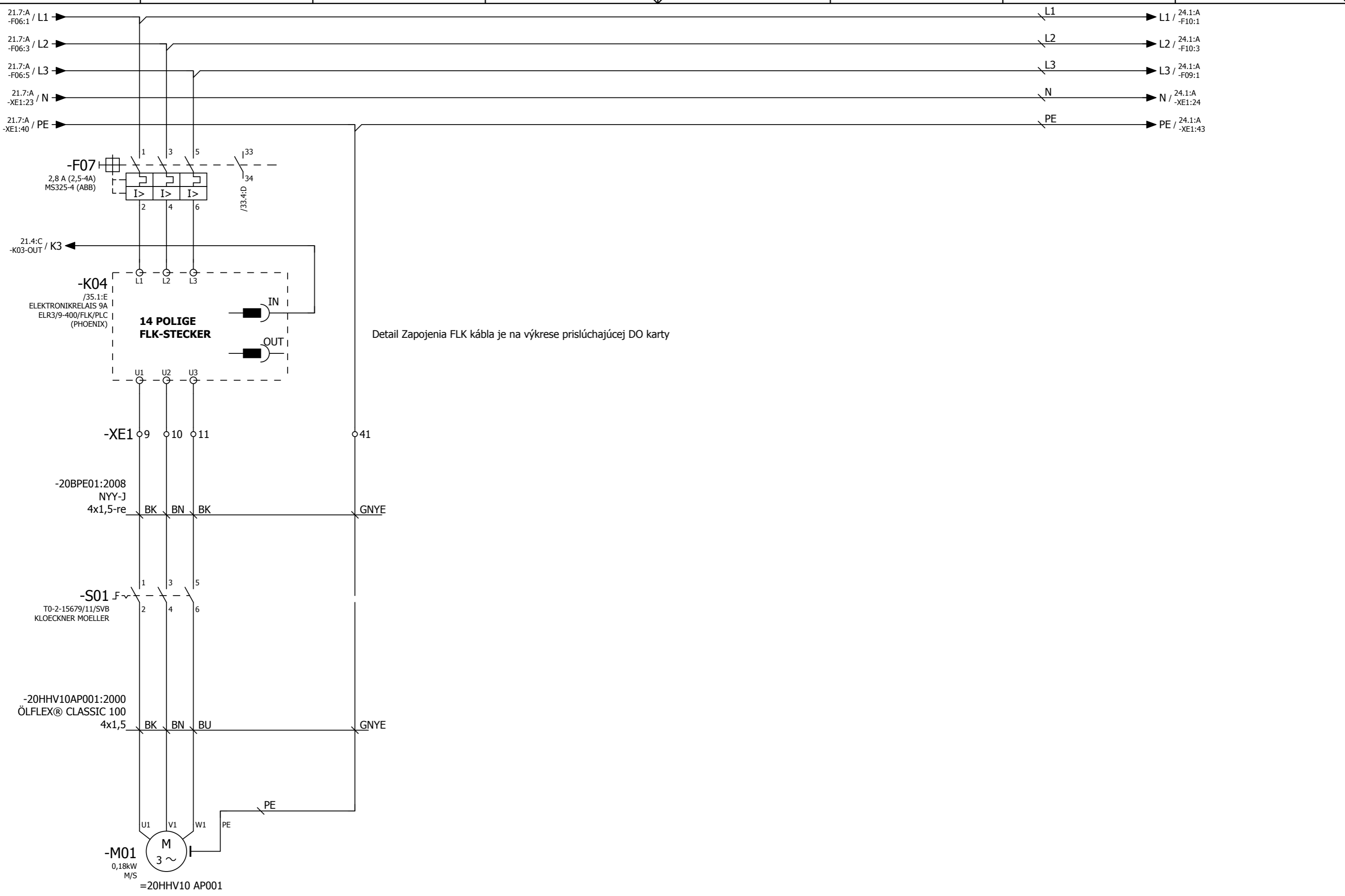

Revizia	Dátum	Meno	Datum
			6/2016

Vypracoval Tomáš Sivok Kontroloval Began Schválil Began	Zákazník: Odvoz a likvidácia odpadu a.s. Zákazka: Riadenie rošta
---	---

**SIEMENS**  
SIEMENS s.r.o. „Lamačská cesta 3/A  
841 04 Bratislava - SK

**FU Rozvádzač / Pohony kúrenia**  
**Pumpa mastenia tukom**

REV: 6/2016 PSV	D1 =	+20BPE01
Arch. číslo: P.02091.01		
	List	22
	Listov	31

© Copyright SIEMENS s.r.o. 2015

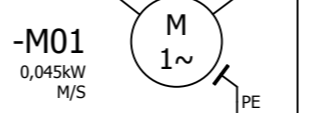
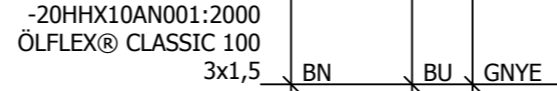
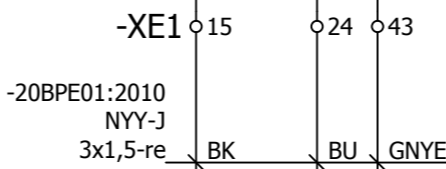
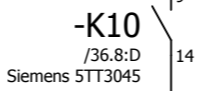
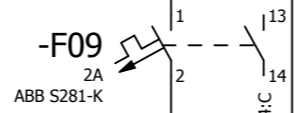
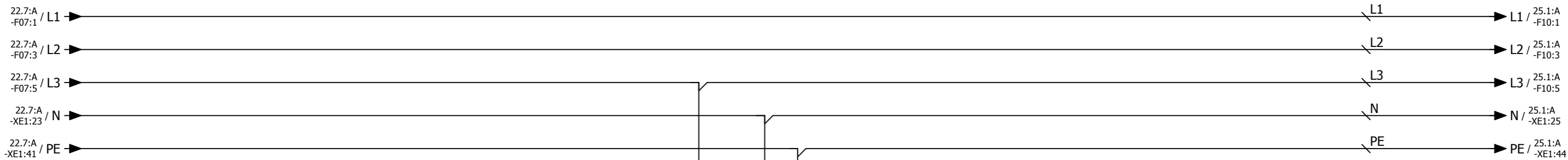

==20HHX10 AN001

		Vypracoval Tomáš Sivok		Zákazník: Odvoz a likvidácia odpadu a.s.		<b>SIEMENS</b>		FU Rozvádzač / Pohony kúrenia		=	
		Kontroloval Began		Zákazka: Riadenie rošta		SIEMENS s.r.o. „Lamačská cesta 3/A 841 04 Bratislava - SK		Ventilátor Chladiaceho vzduchu		+20BPE01	
		Schválil Began						REV: 6/2016 PSV		List 24	
Revizia	Dátum	Meno	Datum					Arch. číslo: P.02091.01		Listov 31	
1		2		3		4		5		6	7

© Copyright SIEMENS s.r.o. 2015

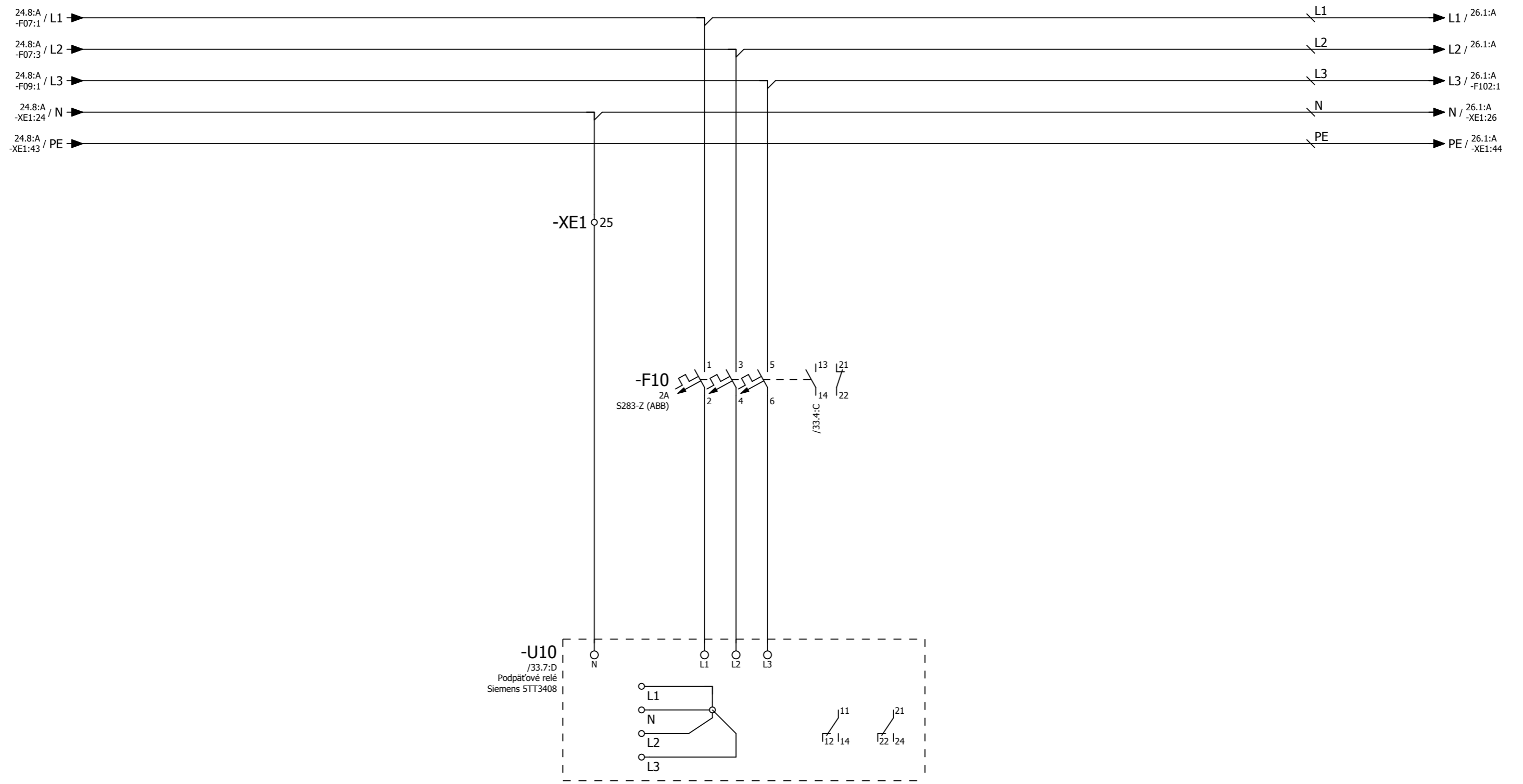

			Vypracoval Tomáš Sivok Kontroloval Began Schválil Began Datum 6/2016	Zákazník: Odvoz a likvidácia odpadu a.s. Zákazka: Riadenie rošta	<b>SIEMENS</b> SIEMENS s.r.o. , Lamačská cesta 3/A 841 04 Bratislava - SK	<b>FU Rozvádzač / Pohony kúrenia</b>  <b>Sledovanie podpatia</b>	= REV: 6/2016 PSV Arch. číslo: P.02091.01	+20BPE01 List 25 Listov 31
1	2	3	4	5	6	7	8	

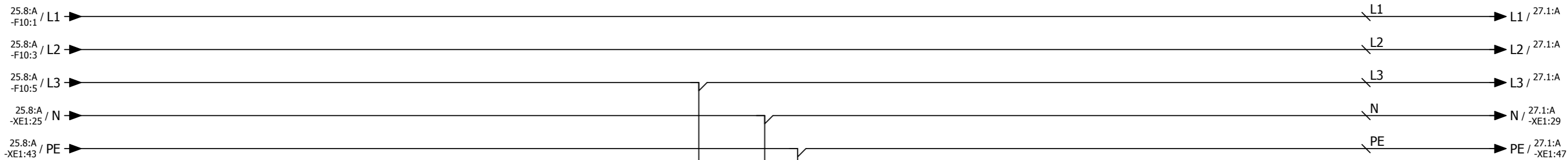

**-F102**  
4A  
DII/25 E27

-XE1 26 44

**-U11**  
/34.2:D  
Regulácia otáčok ventilátora  
Rittal SK3120 000

Cca 40st.C  
Porucha

**-R01**  
NTC teplotný snímač

**-M01**  
Rittal SK3325 100  
0,041kW

**-M02**  
Rittal SK3325 100  
0,041kW

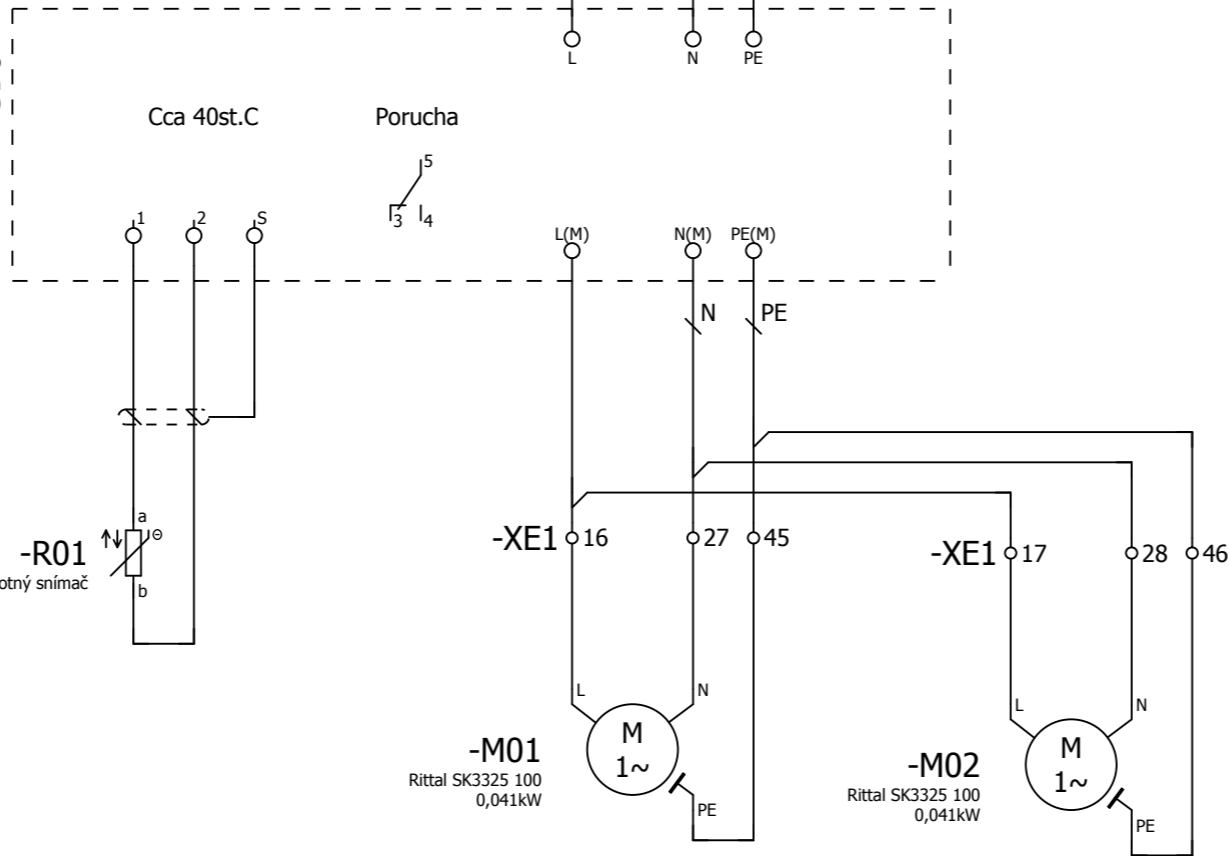

			Vypracoval Tomáš Sivok	Zákazník: Odvoz a likvidácia odpadu a.s.
			Kontroloval Began	Zákazka: Riadenie rošta
			Schválil Began	
Revízia	Dátum	Meno	Datum	6/2016

--	--	--	--	--

**SIEMENS**  
SIEMENS s.r.o. ,Lamačská cesta 3/A  
841 04 Bratislava - SK

**FU Rozvádzač / Pohony kúrenia**  
**Ventilátor rozvádzača**





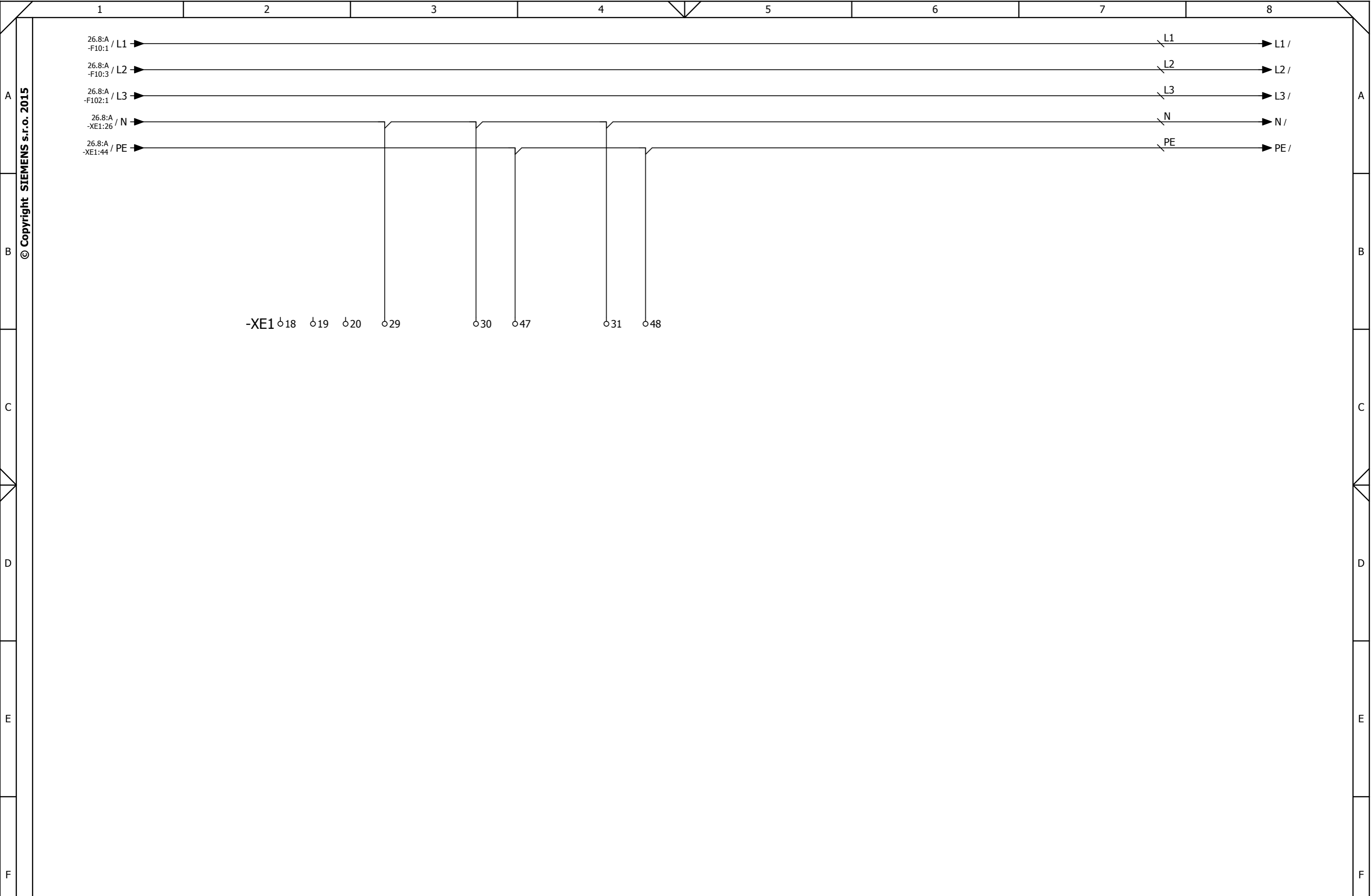

© Copyright SIEMENS s.r.o. 2015

			Vypracoval Tomáš Sivok	Zákazník: Odvoz a likvidácia odpadu a.s.	<b>SIEMENS</b>	<b>FU Rozvádzač / Pohony kúrenia</b>		=
			Kontroloval Began	Zákazka: <b>Riadenie rošta</b>	SIEMENS s.r.o. , Lamačská cesta 3/A 841 04 Bratislava - SK		REV: 6/2016 PSV	+20BPE01
			Schválil Began				Arch. číslo: P.02091.01	List 27
Revizia	Dátum	Meno	Datum 6/2016			<b>Rezerva</b>		Listov 31

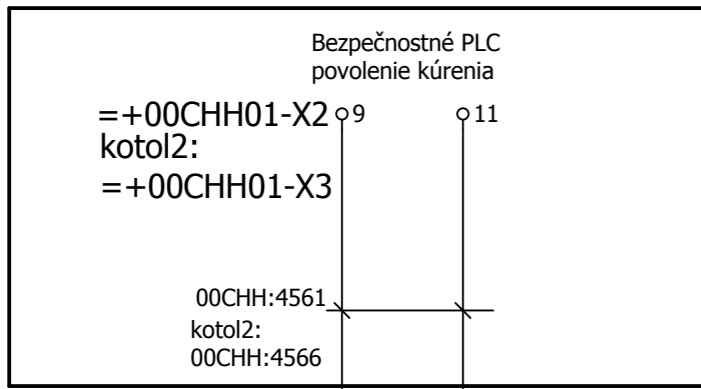

-X10 11 12 14 15 16 17 18 19 20

K101+  
32.6:B  
-X01:6

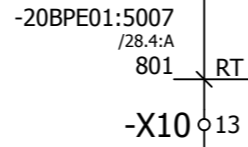
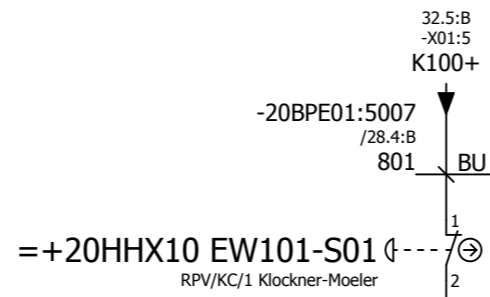

-K100  
Siemens 3TK2907

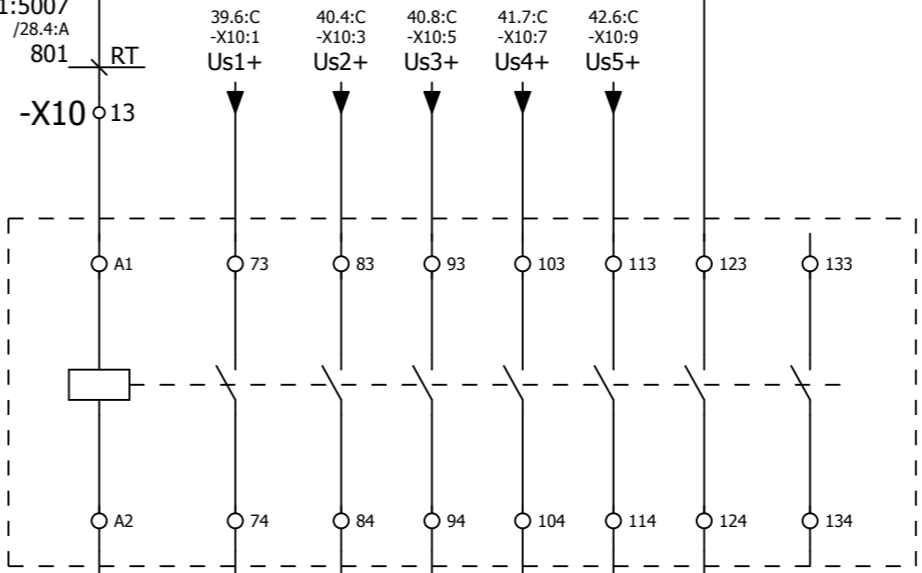

K100-  
32.5:B  
-X01:18

33.6:D  
-A5.1:11  
K100s-

33.3:D  
-A5.1:1  
K101s-

-K101  
Siemens 3TK2907

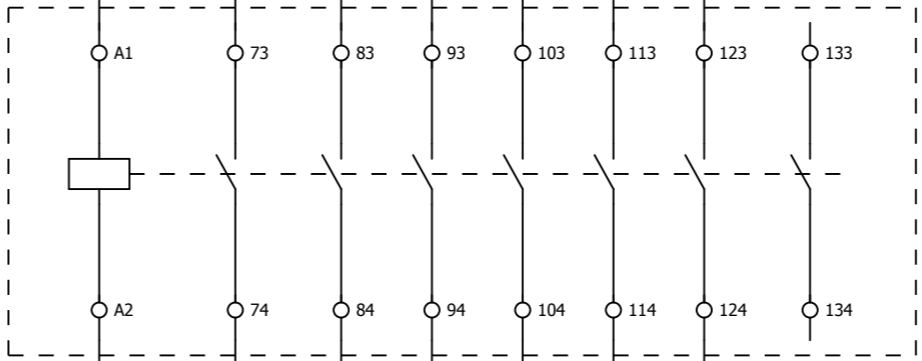

K101-  
32.6:B  
-X01:19

Us1-  
39.5:C  
-X10:2

Us2-  
40.4:C  
-X10:4

Us3-  
40.8:C  
-X10:6

Us4-  
41.7:C  
-X10:8

Us5-  
42.5:C  
-X10:10

K101s+  
33.3:D  
-A5.1:9

			Vypracoval Tomáš Sivok
			Kontroloval Began
			Schválil Began
Revízia	Dátum	Meno	Datum 6/2016

Zákazník: Odvoz a likvidácia odpadu a.s.  
Zákazka: Riadenie rošta

**SIEMENS**  
SIEMENS s.r.o. „Lamačská cesta 3/A  
841 04 Bratislava - SK

**FU Rozvádzač / Pohony kúrenia**  
**Núdzové vypnutie a ochrana kotla**

	=
REV: 6/2016 PSV	+20BPE01
Arch. číslo: P.02091.01	List 28
	Listov 31

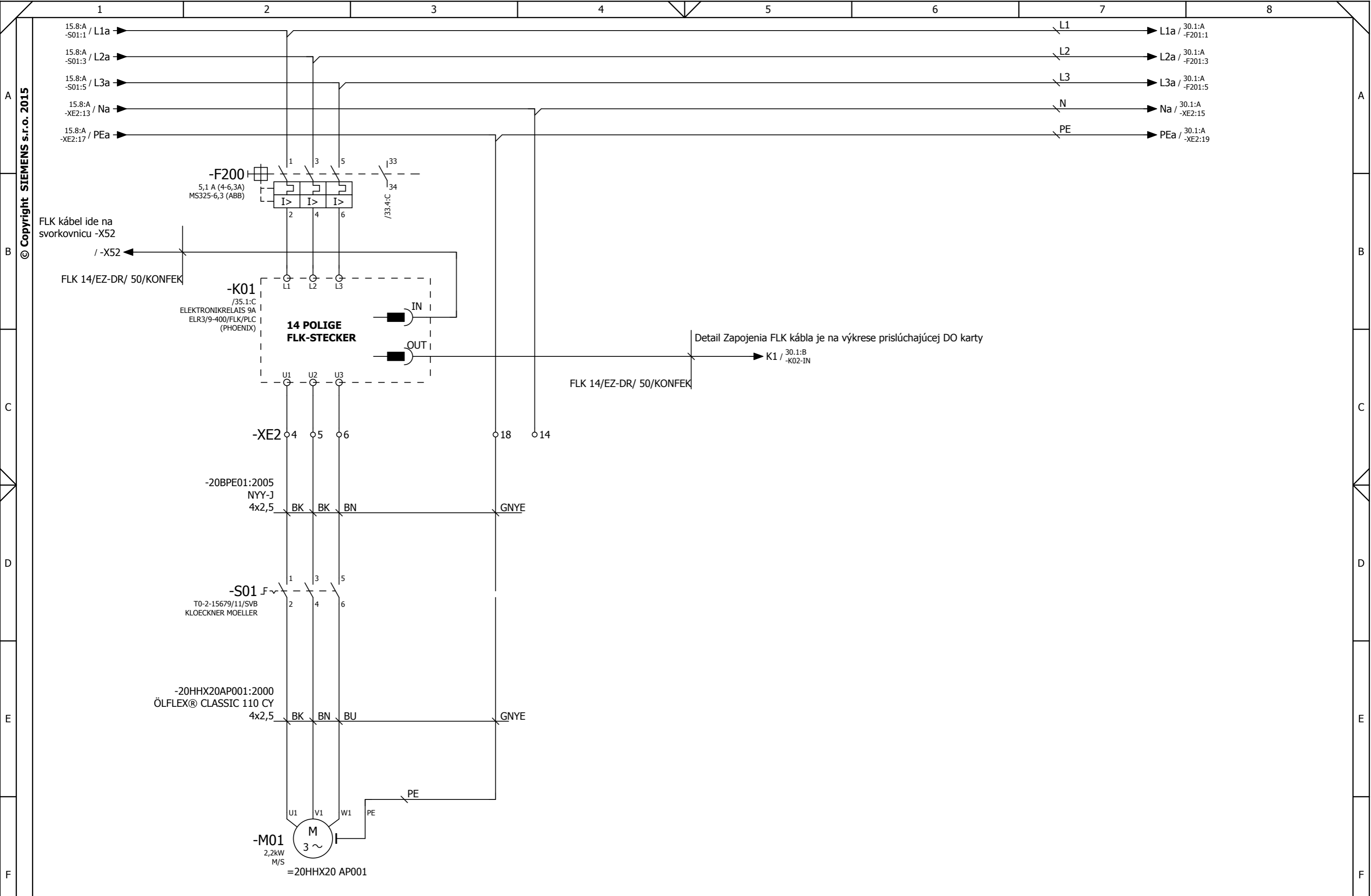

			Vypracoval Tomáš Sivok
			Kontroloval Began
			Schválil Began
Revizia	Dátum	Meno	Datum 6/2016

Zákazník: Odvoz a likvidácia odpadu a.s.
Zákazka: Riadenie rošta

**SIEMENS**  
 SIEMENS s.r.o. , Lamačská cesta 3/A  
 841 04 Bratislava - SK

**FU Rozvádzač / Pohony kúrenia**  
**Hydraulika - pretlaková pumpa 1**

REV: 6/2016 PSV	D1 =	+20BPE01
Arch. číslo: P.02091.01		List 29
		Listov 31

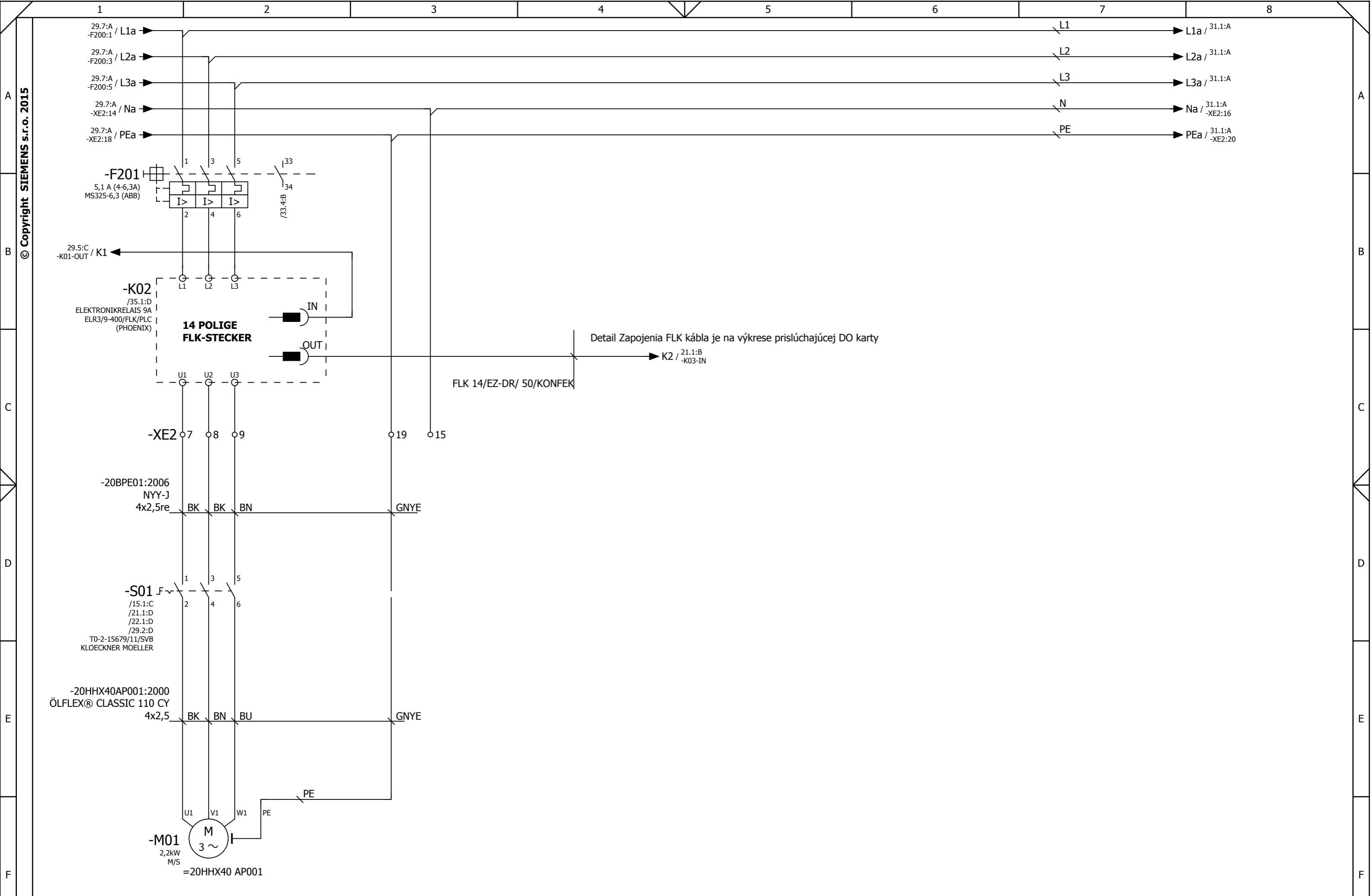

© Copyright SIEMENS s.r.o. 2015

Revizia	Dátum	Meno	Datum
			6/2016

Vypracoval Tomáš Sivok Kontroloval Began Schválil Began	Zákazník: Odvoz a likvidácia odpadu a.s. Zákazka: Riadenie rošta
---	---

**SIEMENS**  
 SIEMENS s.r.o. ,Lamačská cesta 3/A  
 841 04 Bratislava - SK

**FU Rozvádzač / Pohony kúrenia**  
**Hydraulika - pretlaková pumpa 2**

REV: 6/2016 PSV	D1 =	+20BPE01
Arch. číslo: P.02091.01		
	List	30
	Listov	31

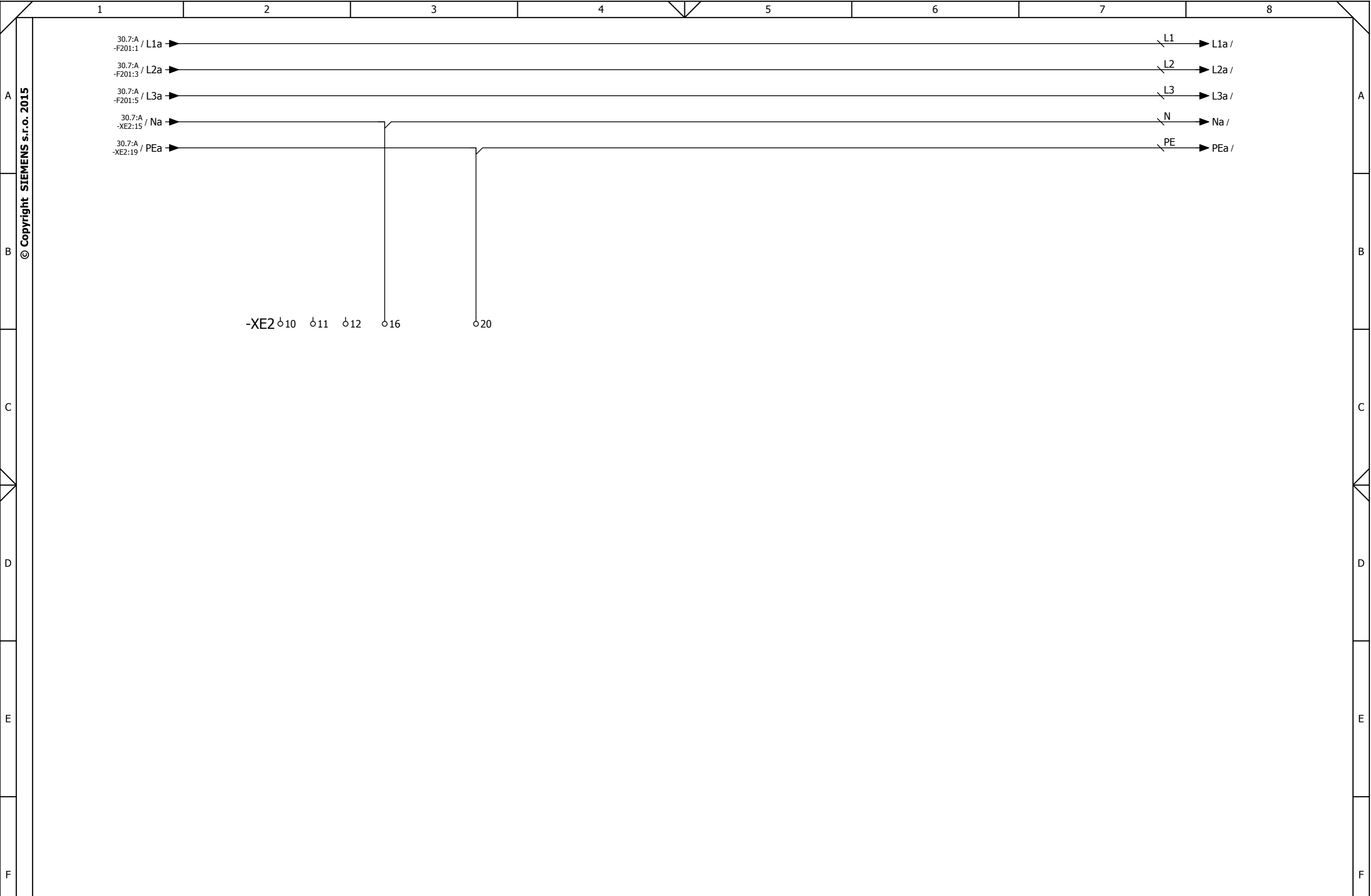

© Copyright SIEMENS s.r.o. 2015

			Vypracoval Tomáš Sivok	Zákazník: Odvoz a likvidácia odpadu a.s.	<b>SIEMENS</b> SIEMENS s.r.o. „Lamačská cesta 3/A 841 04 Bratislava - SK	<b>FU Rozvádzač / Pohony kúrenia</b>		=
			Kontroloval Began	Zákazka: <b>Riadenie rošta</b>			REV: 6/2016 PSV	+20BPE01
			Schválil Began				Arch. číslo: P.02091.01	List 31
Revizia	Dátum	Meno	Datum	6/2016		<b>Rezerva</b>		Listov 31

© Copyright SIEMENS s.r.o. 2015

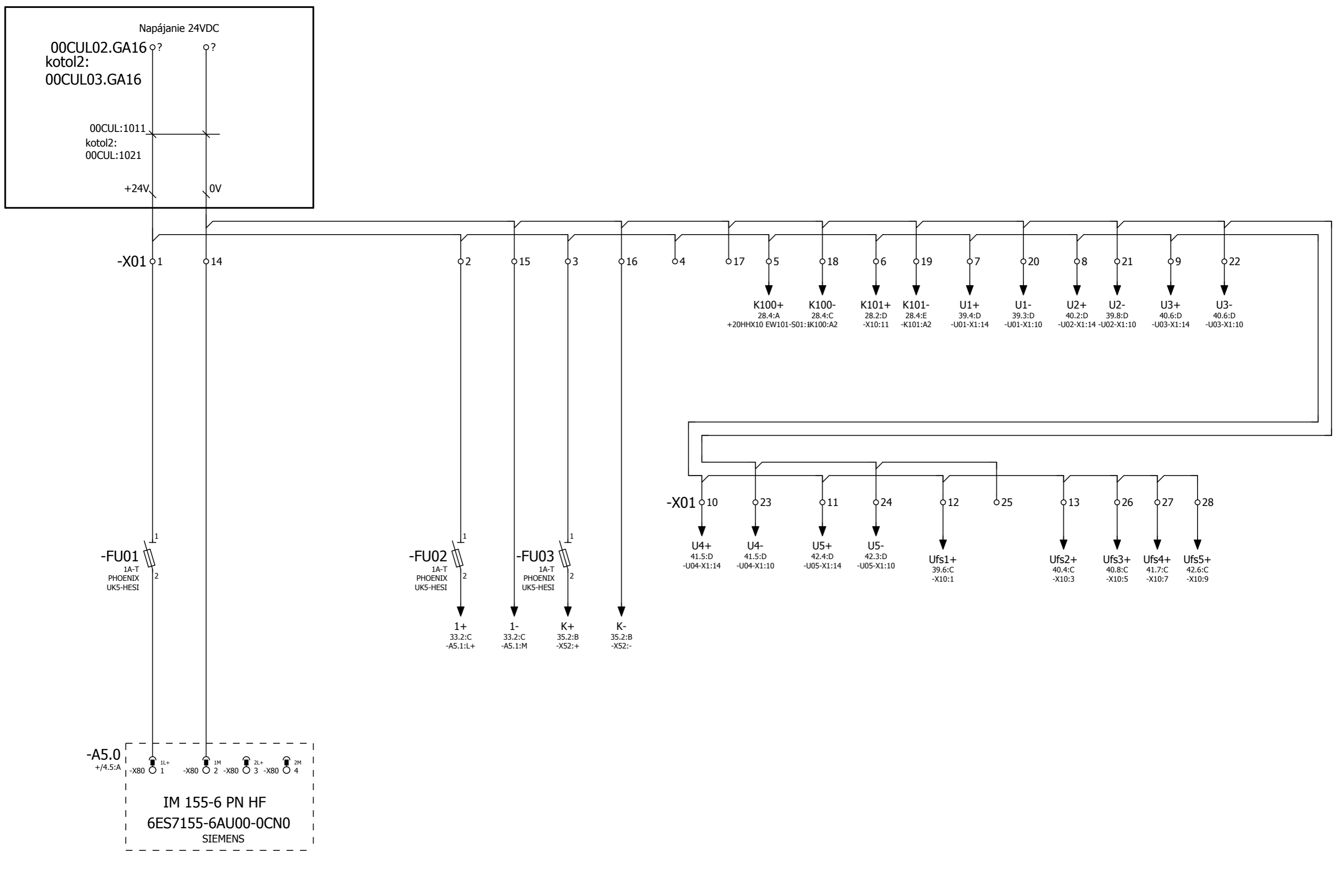

			Vypracoval	Tomáš Sivok
			Kontroloval	Began
			Schválil	Began
Revízia	Dátum	Meno	Datum	6/2016

Zákazník:	Odvoz a likvidácia odpadu a.s.
Zákazka:	Riadenie rošta

**SIEMENS**  
 SIEMENS s.r.o. „Lamačská cesta 3/A  
 841 04 Bratislava - SK

**FU Rozvádzač / Pohony kúrenia**  
**Napájanie 24V DC**

		=
REV: 6/2016 PSV		+20BPE01
Arch. číslo:	P.02091.01	List 32
		Listov 31

-A5.1  
/34.1:A  
Rack X  
Slot Y

6ES7131-6BF00-0BA0 + BU15-P16+A10+2D DI 8x24 VDC ST

SIEMENS

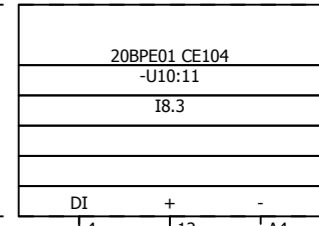
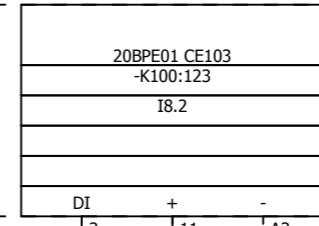
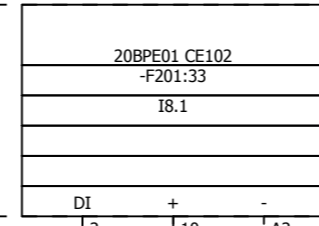
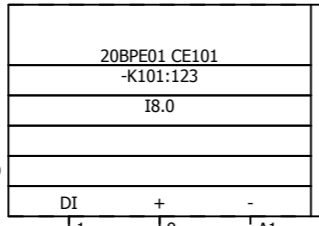
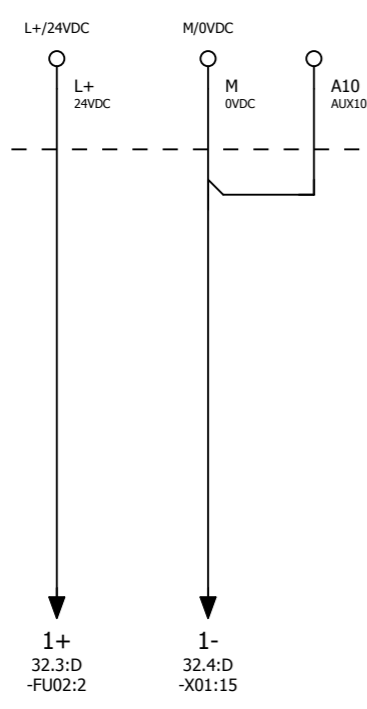

- F201 /30.1:B
- F200 /29.2:B
- F10 /25.4:C
- F09 /24.4:B
- F07 /22.1:B
- F06 /21.1:B
- F05 /20.1:B
- F04 /19.1:B
- F03 /18.1:B
- F02 /17.1:B
- F01 /16.1:B

+20BPE01 CE102  
Rozvádzač FU pohony kúrenia- Napájanie pohonov OK

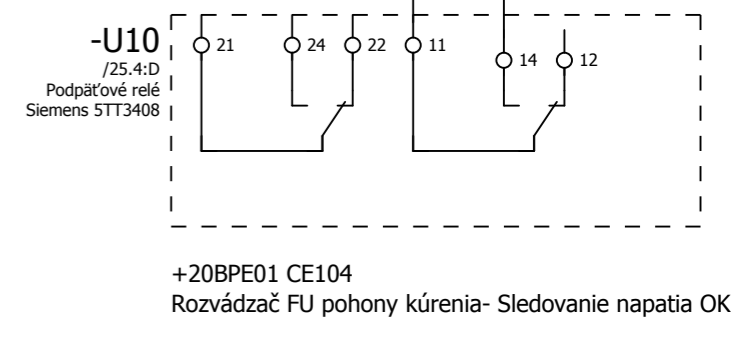

© Copyright SIEMENS s.r.o. 2015

			Vypracoval Tomáš Sivok
			Kontroloval Began
			Schválil Began
Revizia	Dátum	Meno	Datum 6/2016

Zákazník: Odvoz a likvidácia odpadu a.s.
Zákazka: Riadenie rošta

**SIEMENS**  
SIEMENS s.r.o. ,Lamačská cesta 3/A  
841 04 Bratislava - SK

**FU Rozvádzač / Pohony kúrenia**  
  
**DI karta 1-4**

=	
REV: 6/2016 PSV	+20BPE01
Arch. číslo: P.02091.01	List 33
	Listov 31

-A5.1  
/33.1:A  
Rack X  
Slot Y

6ES7131-6BF00-0BA0 + BU15-P16+A10+2D DI 8x24 VDC ST

SIEMENS

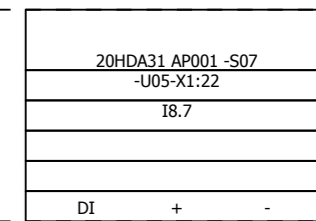
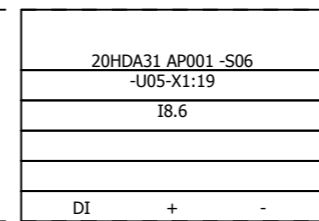
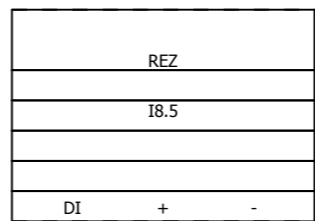
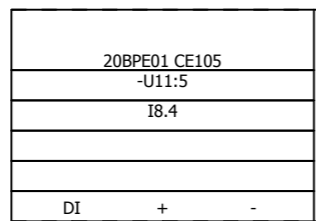

5 13 A5

6 14 A6

7 15 A7

8 16 A8

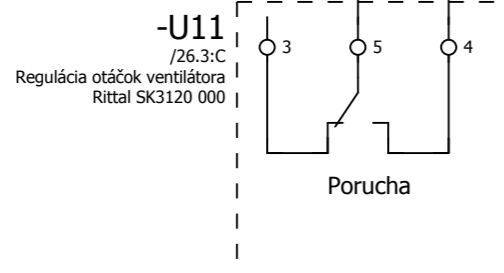

=20HDA31 AP001

OK/Porucha  
=20HDA31 AP001 -S06

Chod  
=20HDA31 AP001 -S07

			Vypracoval Tomáš Sivok
			Kontroloval Began
			Schválil Began
Revízia	Dátum	Meno	Datum 6/2016

Zákazník: Odvoz a likvidácia odpadu a.s.
Zákazka: Ríadenie rošta

**SIEMENS**  
SIEMENS s.r.o. „Lamačská cesta 3/A  
841 04 Bratislava - SK

**FU Rozvádzač / Pohony kúrenia**  
  
**DI karta 5-8**

				=
				+20BPE01
				List 34
				Listov 31

© Copyright SIEMENS s.r.o. 2015

© Copyright SIEMENS s.r.o. 2015



© Copyright SIEMENS s.r.o. 2015

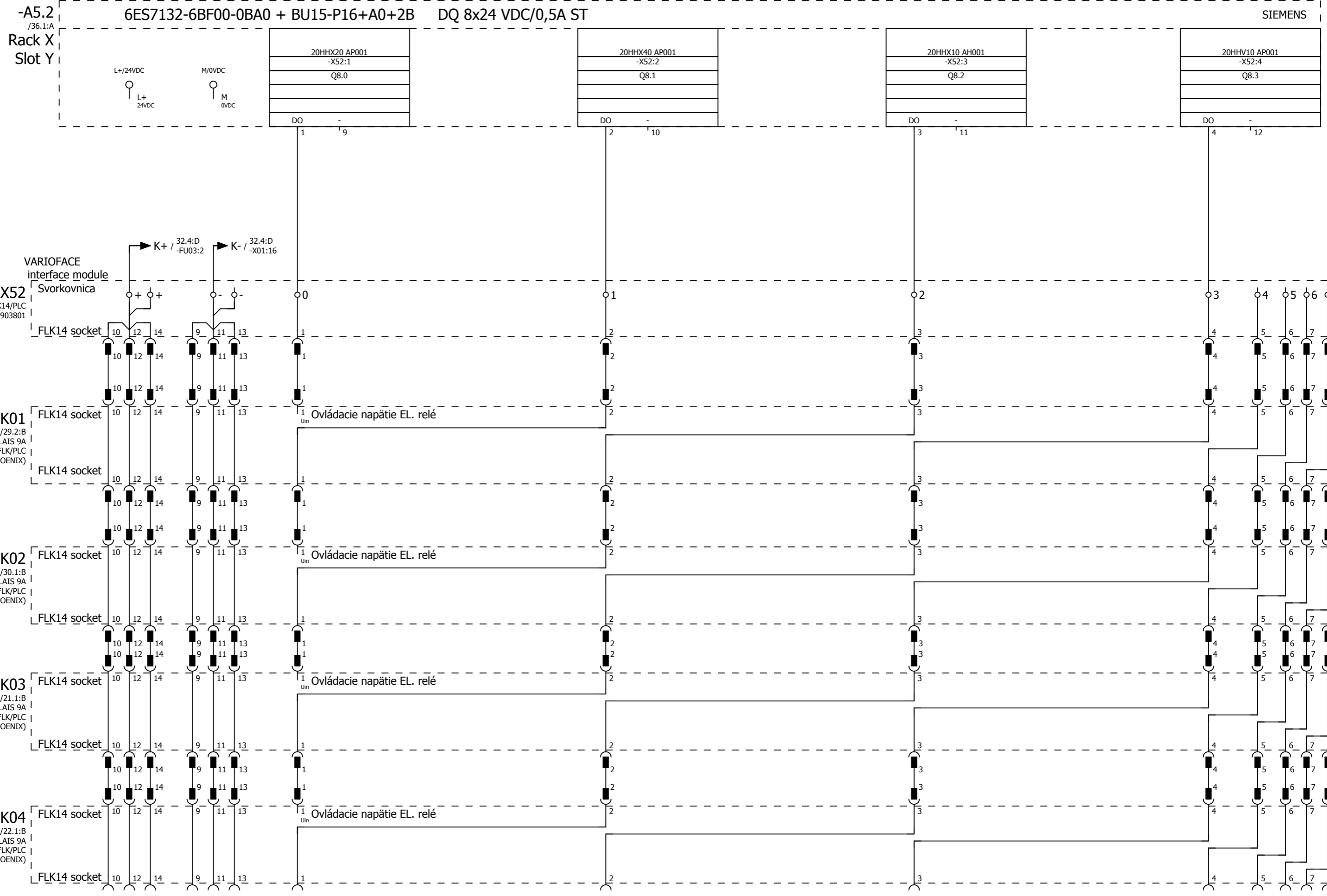

Revízia	Dátum	Meno	Datum
		Schválil	6/2016
		Kontroloval	
		Tomáš Sivok	

Zákazník:	Odvoz a likvidácia odpadu a.s.
Zákazka:	Riadenie rošta

**SIEMENS**  
SIEMENS s.r.o. „Lamačská cesta 3/A  
841 04 Bratislava - SK

**FU Rozvádzač / Pohony kúrenia**  
**4DO karta**

REV: 6/2016 PSV	=
Arch. číslo: P.02091.01	+20BPE01
	List 35
	Listov 31

-A5.2  
/35.1:A  
Rack X  
Slot Y

6ES7132-6BF00-0BA0 + BU15-P16+A0+2B DQ 8x24 VDC/0,5A ST

SIEMENS

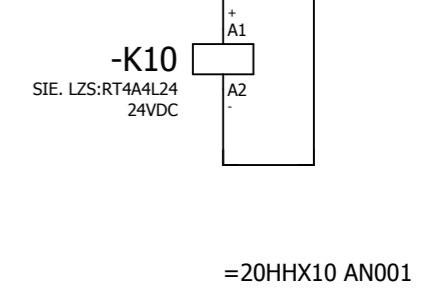
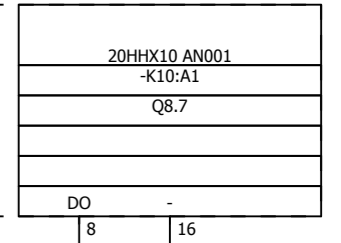
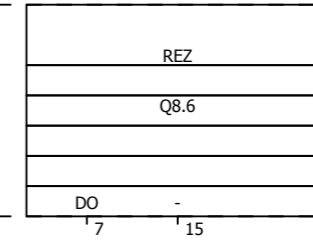
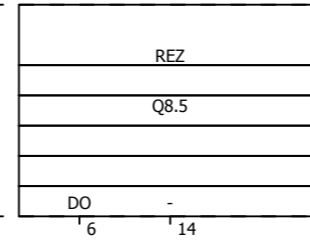
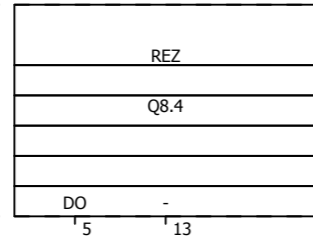

9 - 14 /24.4:B

© Copyright SIEMENS s.r.o. 2015

			Vypracoval Tomáš Sivok
			Kontroloval Began
			Schválil Began
Revízia	Dátum	Meno	Datum 6/2016

Zákazník: Odvoz a likvidácia odpadu a.s.
Zákazka: Riadenie rošta

**SIEMENS**  
SIEMENS s.r.o. „Lamačská cesta 3/A  
841 04 Bratislava - SK

**FU Rozvádzač / Pohony kúrenia**  
**4DO karta**

		=
REV: 6/2016 PSV		+20BPE01
Arch. číslo: P.02091.01		List 36
		Listov 31

© Copyright SIEMENS s.r.o. 2015

-A5.3  
/38.1:A  
Rack X  
Slot Y

6ES7131-6BF00-0BA0 + BU15-P16+A10+2B DI 8x24 VDC ST

SIEMENS

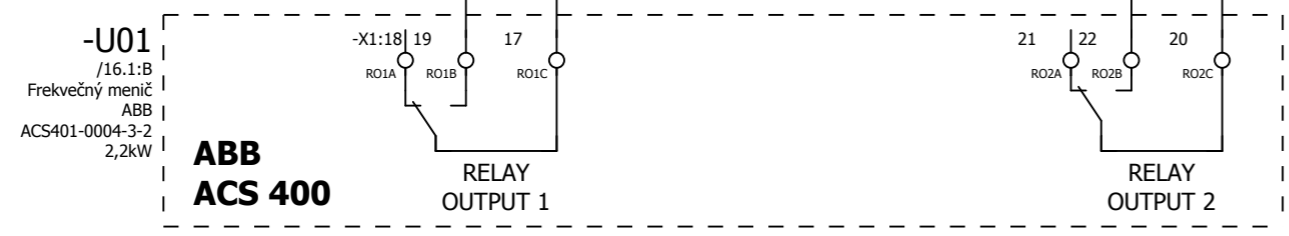
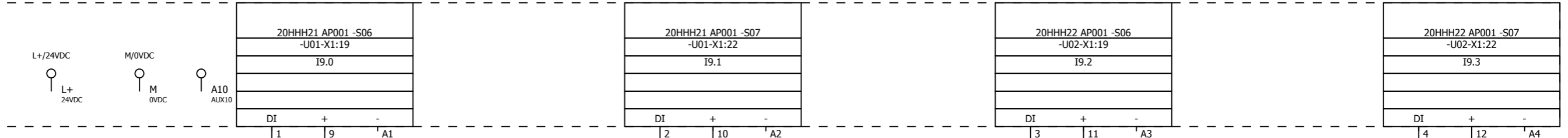

**ABB ACS 400**

RELAY OUTPUT 1

RELAY OUTPUT 2

=20HHH21 AP001

OK/Porucha

Chod

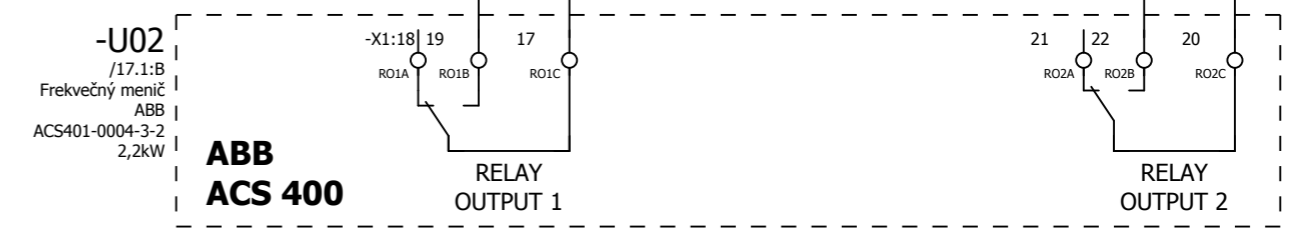

**ABB ACS 400**

RELAY OUTPUT 1

RELAY OUTPUT 2

=20HHH22 AP001

OK/Porucha

Chod

		Vypracoval Tomáš Sivok		Zákazník: Odvoz a likvidácia odpadu a.s.		<b>SIEMENS</b>		FU Rozvádzač / Pohony kúrenia		=	
		Kontroloval Began		Zákazka: Ríadenie rošta		SIEMENS s.r.o. ,Lamačská cesta 3/A 841 04 Bratislava - SK				+20BPE01	
		Schválil Began						REV: 6/2016 PSV		List 37	
Revízia	Dátum	Meno	Datum					Arch. číslo: P.02091.01		Listov 31	
1		2		3	4	5	6	7	DI karta 1-4		

-A5.3  
/37.1:A  
Rack X  
Slot Y

6ES7131-6BF00-0BA0 + BU15-P16+A10+2B DI 8x24 VDC ST

SIEMENS

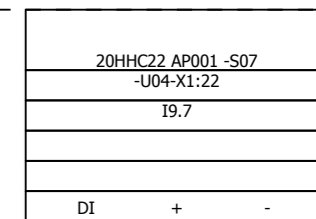
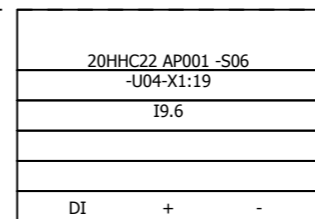
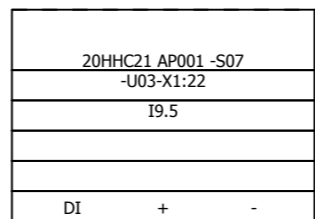
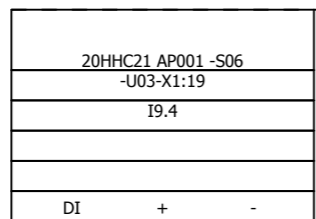

-U03  
/18.1:B  
Frekvenčný menič  
ABB  
ACS401-0006-3-2  
4kW

**ABB  
ACS 400**

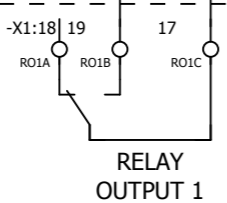

RELAY  
OUTPUT 1

=20HHC21 AP001

OK/Porucha

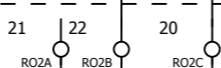

RELAY  
OUTPUT 2

Chod

-U04  
/19.1:B  
Frekvenčný menič  
ABB  
ACS401-0006-3-2  
4kW

**ABB  
ACS 400**

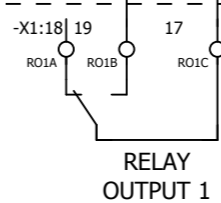

RELAY  
OUTPUT 1

=20HHC22 AP001

OK/Porucha

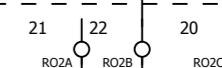

RELAY  
OUTPUT 2

Chod

© Copyright SIEMENS s.r.o. 2015

Revízia	Dátum	Meno	Datum
1	2	3	4

Vypracoval	Tomáš Sivok	Zákazník:	Odvoz a likvidácia odpadu a.s.
Kontroloval	Began	Zákazka:	<b>Riadenie rošta</b>
Schválil	Began		
Datum	6/2016		

**SIEMENS**  
SIEMENS s.r.o. „Lamačská cesta 3/A  
841 04 Bratislava - SK

**FU Rozvádzač / Pohony kúrenia**  
  
**DI karta 5-8**

REV: 6/2016 PSV	=
Arch. číslo: P.02091.01	+20BPE01
	List 38
	Listov 31

-A5.4  
/40.1:A  
Rack X  
Slot Y

6ES7132-6BF00-0BA0 + BU15-P16+A0+2B DQ 8x24 VDC/0,5A ST

SIEMENS

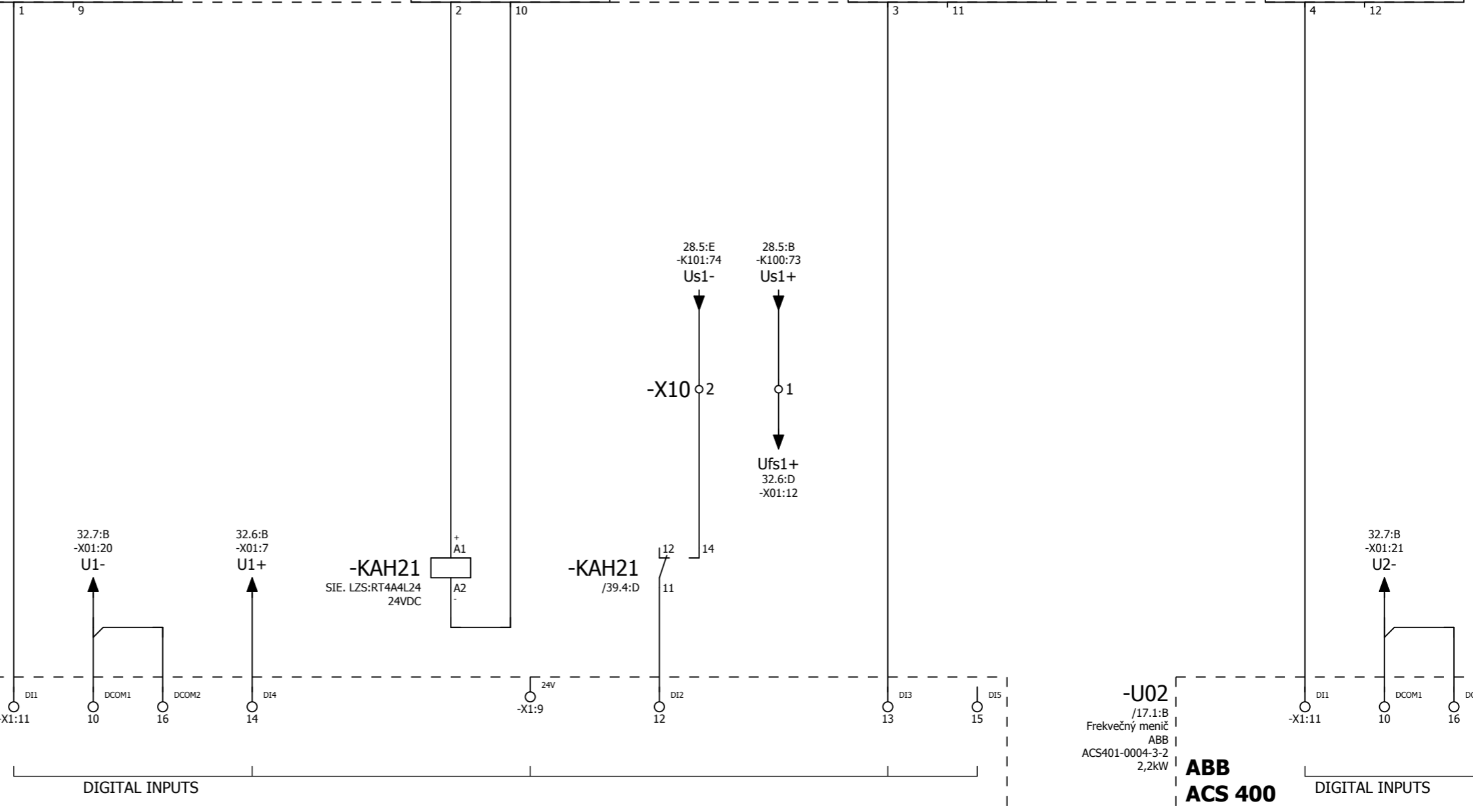
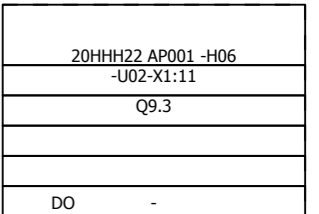
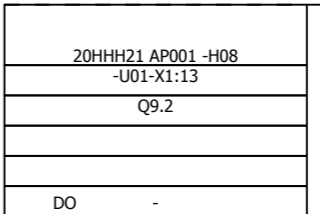
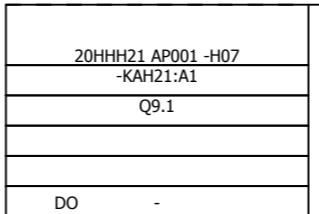
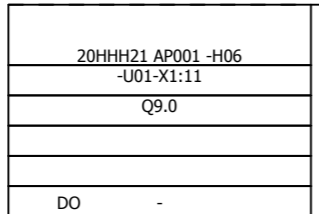

**ABB ACS 400**

**ABB ACS 400**

=20HHH21 AP001

=20HHH22 AP001

Štart      Control mode Factory(1)      STOP      Reverz      Ramp selection

Štart

14 ↗  
12 ↘    11 /39.5:D

Vypracoval Tomáš Sivok			Zákazník: Odvoz a likvidácia odpadu a.s.		<b>SIEMENS</b>		FU Rozvádzač / Pohony kúrenia		=	
Kontroloval Began			Zákazka: Riadenie rošta		SIEMENS s.r.o. ,Lamačská cesta 3/A 841 04 Bratislava - SK		REV: 6/2016 PSV		+20BPE01	
Schválil Began							Arch. číslo: P.02091.01		List 39	
Revízia	Dátum	Meno	Datum	6/2016			4DO karta		Listov 31	
1		2		3		4		5		6
										7
										8

© Copyright SIEMENS s.r.o. 2015

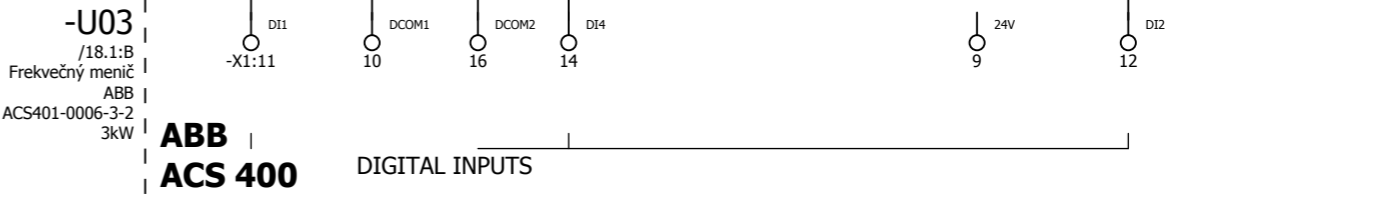
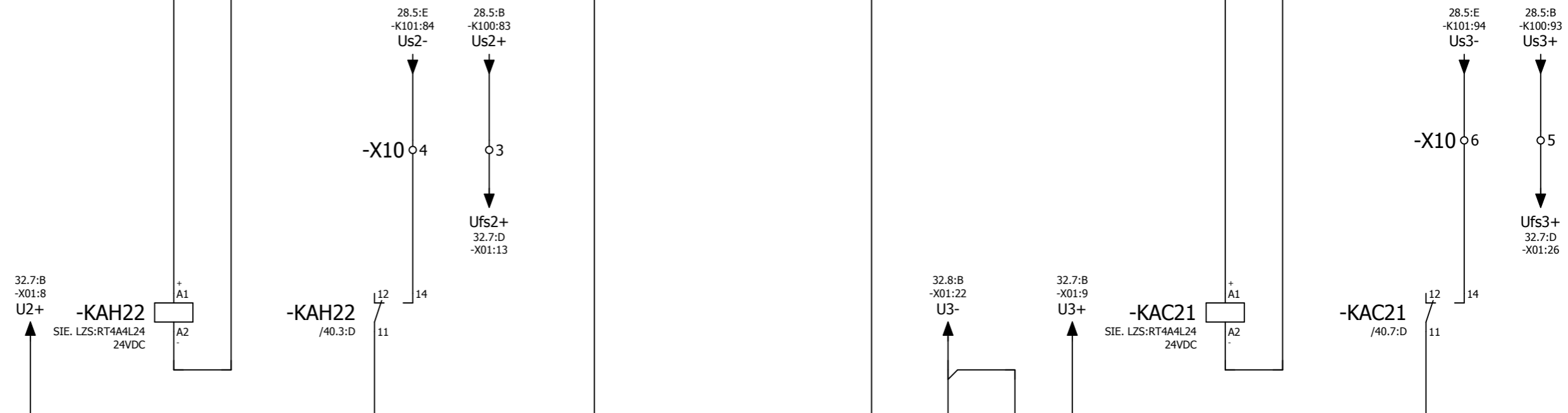
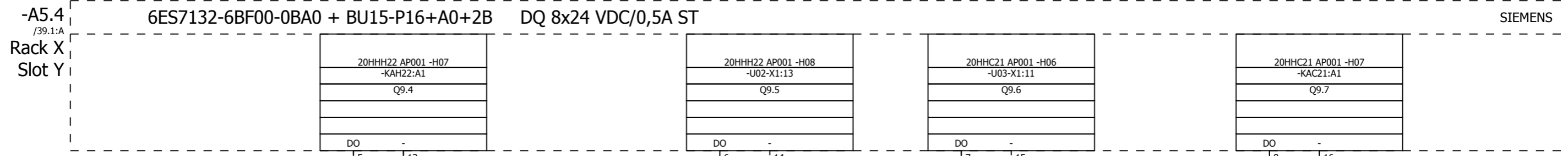

=20HHH22 AP001      Control mode Factory(1)      STOP      Reverz      Ramp selection

=20HHC21 AP001      Štart      Control mode Factory(1)      STOP

14 ↙  
12 ↘ 11 /40.3:D

			Vypracoval Tomáš Sivok	Zákazník: Odvoz a likvidácia odpadu a.s.	<b>SIEMENS</b>	FU Rozvádzač / Pohony kúrenia		
			Kontroloval Began	Zákazka: Riadenie rošta	SIEMENS s.r.o. „Lamačská cesta 3/A 841 04 Bratislava - SK	<b>4DO karta</b>		
Revízia	Dátum	Meno	Schválil Began				REV: 6/2016 PSV	=
			Datum 6/2016				Arch. číslo: P.02091.01	+20BPE01
1	2	3	4	5	6	7	8	List 40 Listov 31

-A5.5  
/42.1:A  
Rack X  
Slot Y

6ES7132-6BF00-0BA0 + BU15-P16+A0+2B DQ 8x24 VDC/0,5A ST

SIEMENS

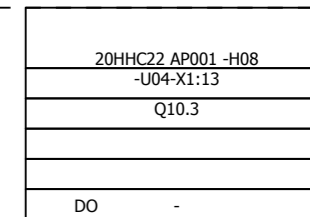
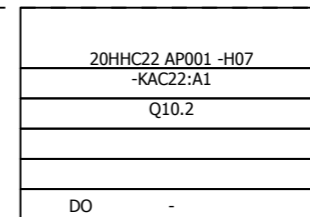
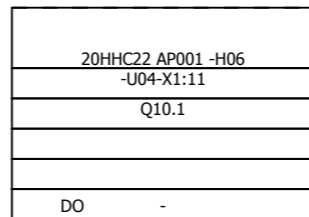
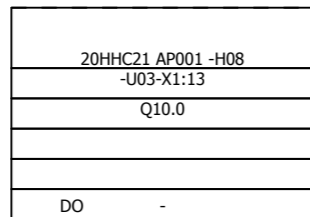

1 9

2 10

3 11

4 12

-U03  
/18.1:B  
Frekvenčný menič  
ABB  
ACS401-0006-3-2  
3kW

**ABB  
ACS 400**

=20HHC21 AP001



DIGITAL INPUTS

Reverz Ramp selection

-U04  
/19.1:B  
Frekvenčný menič  
ABB  
ACS401-0006-3-2  
3kW

**ABB  
ACS 400**

=20HHC22 AP001

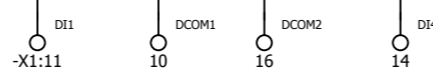

DIGITAL INPUTS

Štart Control mode Factory(1) STOP Reverz Ramp selection

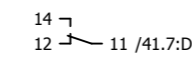
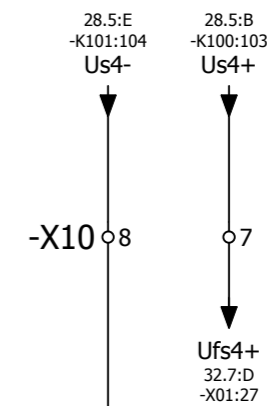
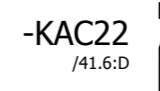

© Copyright SIEMENS s.r.o. 2015

Revizia	Dátum	Meno	Datum	6/2016	Zákazník: Zákazka:	Odvoz a likvidácia odpadu a.s. <b>Riadenie rošta</b>	<b>SIEMENS</b> SIEMENS s.r.o. ,Lamačská cesta 3/A 841 04 Bratislava - SK	<b>FU Rozvádzač / Pohony kúrenia</b>	REV: 6/2016 PSV Arch. číslo: P.02091.01	= +20BPE01 List 41 Listov 31
1	2	3	4	5	6	7	8	4DO karta		





© Copyright SIEMENS s.r.o. 2015

-A5.6  
Rack X  
Slot Y

6ES7134-6GD00-0BA1 + BU15-P16+A0+2B

AI 4xI 2-/4-wire ST

SIEMENS

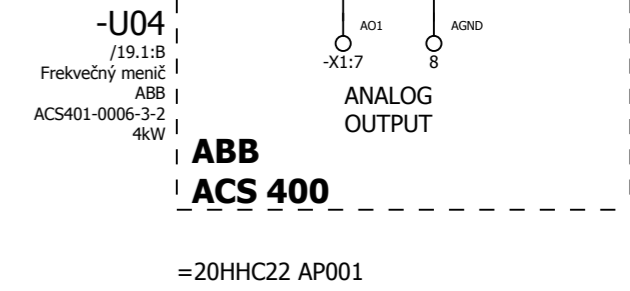
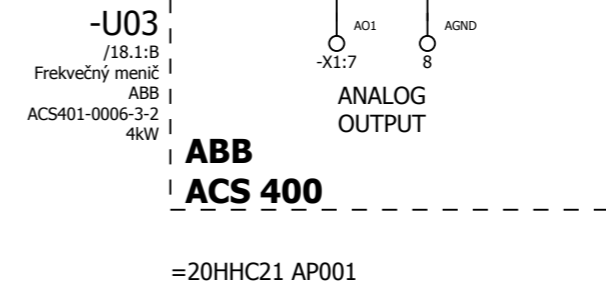
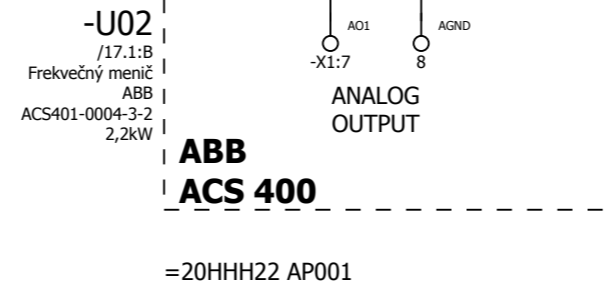
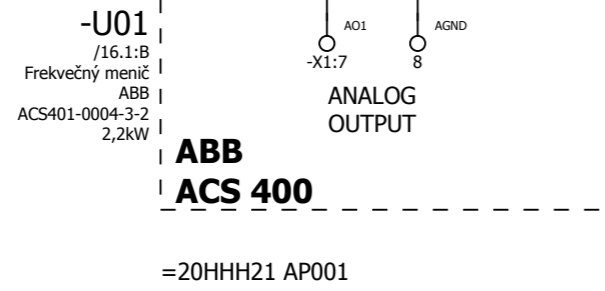
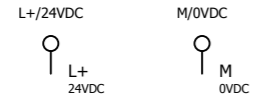

Revizia	Dátum	Meno	Datum
			6/2016
		Schválil	Began
		Kontroloval	Began
		Vypracoval	Tomáš Sivok

Zákazník: Odvoz a likvidácia odpadu a.s.  
Zákazka: **Riadenie rošťa**

**SIEMENS**  
SIEMENS s.r.o. ,Lamačská cesta 3/A  
841 04 Bratislava - SK

**FU Rozvádzač / Pohony kúrenia**

**AI karta**

REV: 6/2016 PSV	=
Arch. číslo: P.02091.01	+20BPE01
	List 43
	Listov 31

1 2 3 4 5 6 7 8

-A5.7  
Rack X  
Slot Y

6ES7134-6GD00-0BA1 + BU15-P16+A0+2B

AI 4xI 2-/4-wire ST

SIEMENS

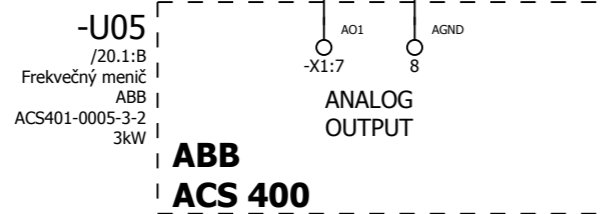
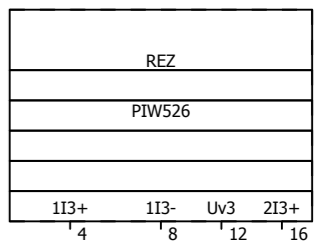
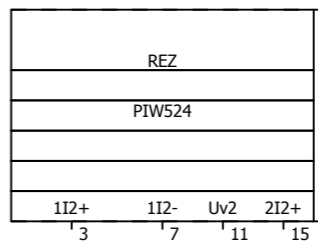
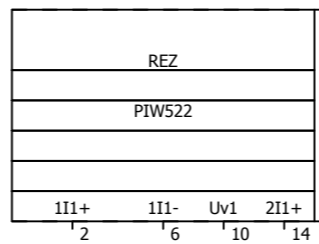
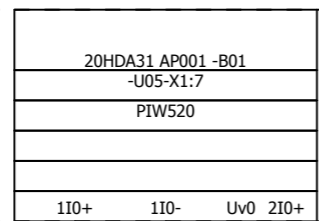
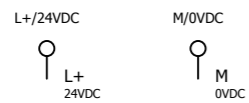

=20HDA31 AP001

© Copyright SIEMENS s.r.o. 2015

			Vypracoval Tomáš Sivok
			Kontroloval Began
			Schválil Began
Revizia	Dátum	Meno	Datum 6/2016

Zákazník:	Odvoz a likvidácia odpadu a.s.
Zákazka:	Riadenie rošta

**SIEMENS**  
SIEMENS s.r.o. ,Lamačská cesta 3/A  
841 04 Bratislava - SK

**FU Rozvádzač / Pohony kúrenia**  
  
**AI karta**

		=
	REV: 6/2016 PSV	+20BPE01
	Arch. číslo: P.02091.01	List 44
		Listov 31

-A5.8  
Rack X  
Slot Y

6ES7135-6HD00-0BA1 + BU15-P16+A0+2B AQ 4xU/I ST

SIEMENS

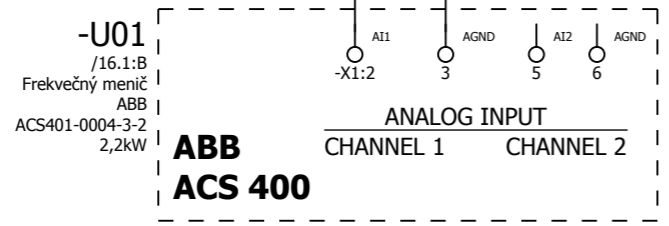
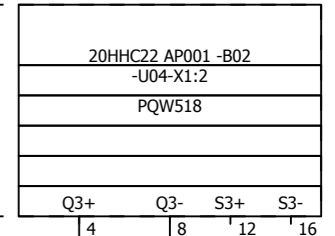
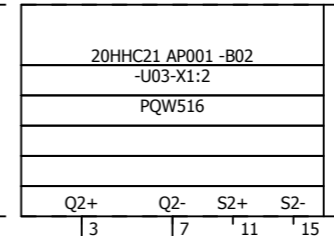
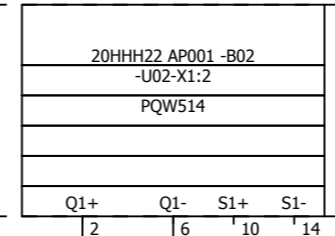
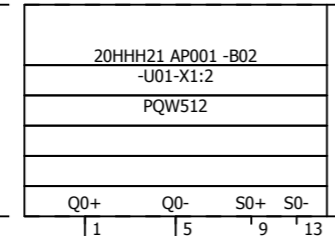
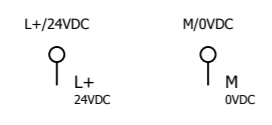

=20HHH21 AP001

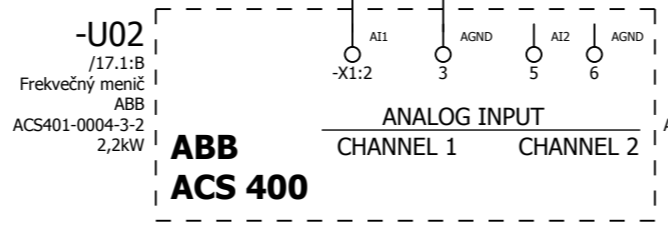

=20HHH22 AP001

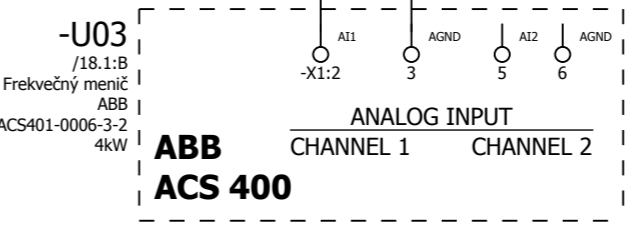

=20HHC21 AP001

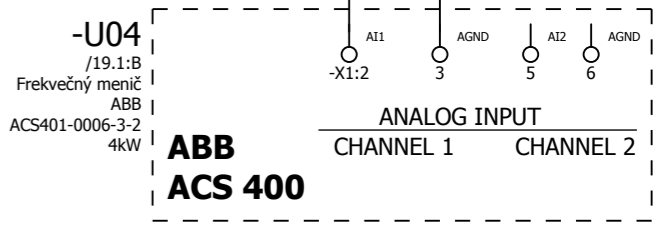

=20HHC22 AP001

			Vypracoval Tomáš Sivok
			Kontroloval Began
			Schválil Began
Revizia	Dátum	Meno	Datum 6/2016

Zákazník: Odvoz a likvidácia odpadu a.s.
Zákazka: Riadenie rošta

**SIEMENS**  
SIEMENS s.r.o. ,Lamačská cesta 3/A  
841 04 Bratislava - SK

**FU Rozvádzač / Pohony kúrenia**  
**AO karta**

	=
REV: 6/2016 PSV	+20BPE01
Arch. číslo: P.02091.01	List 45
	Listov 31

© Copyright SIEMENS s.r.o. 2015

© Copyright SIEMENS s.r.o. 2015

-A5.9  
Rack X  
Slot Y

6ES7135-6HD00-0BA1 + BU15-P16+A0+2B AQ 4xU/I ST

SIEMENS

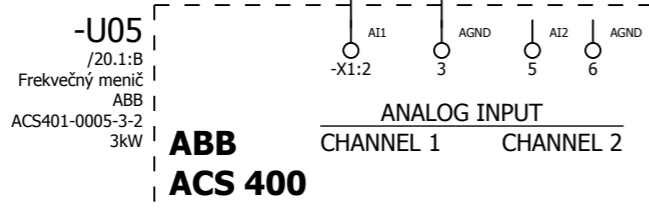
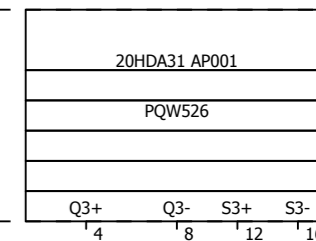
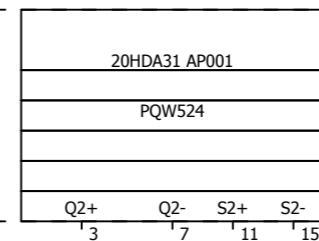
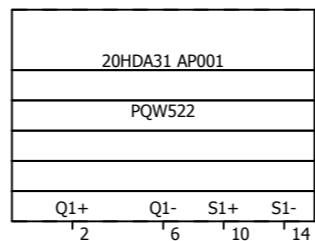
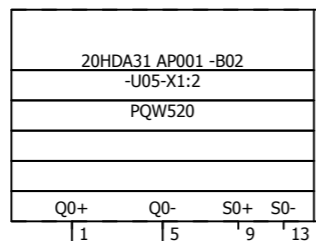
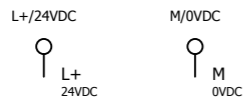

20HDA31 AP001

© Copyright SIEMENS s.r.o. 2015

			Vypracoval Tomáš Sivok
			Kontroloval Began
			Schválil Began
Revizia	Dátum	Meno	Datum 6/2016

Zákazník: Odvoz a likvidácia odpadu a.s.
Zákazka: Riadenie rošta

**SIEMENS**  
SIEMENS s.r.o. ,Lamačská cesta 3/A  
841 04 Bratislava - SK

**FU Rozvádzač / Pohony kúrenia**  
**AO karta**

		=
		+20BPE01
REV: 6/2016 PSV		List 46
Arch. číslo: P.02091.01		Listov 31

© Copyright SIEMENS s.r.o. 2015

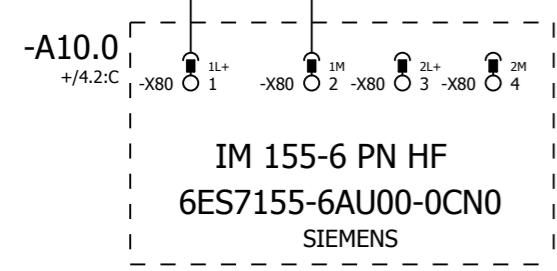
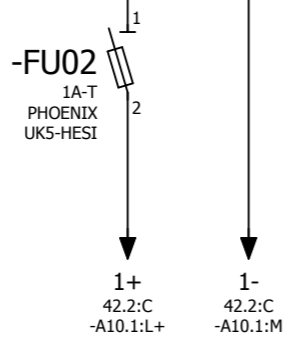
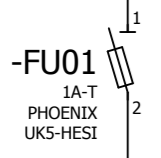
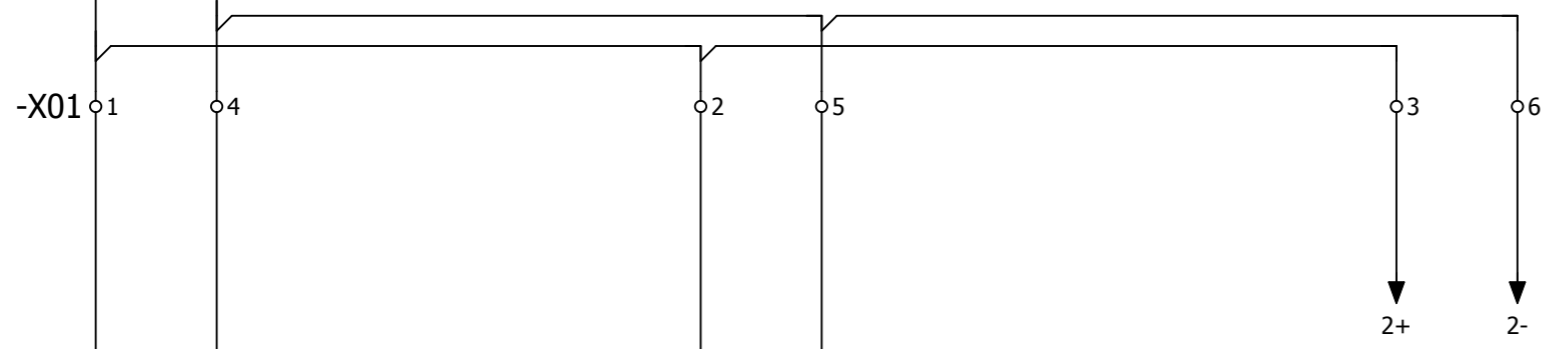
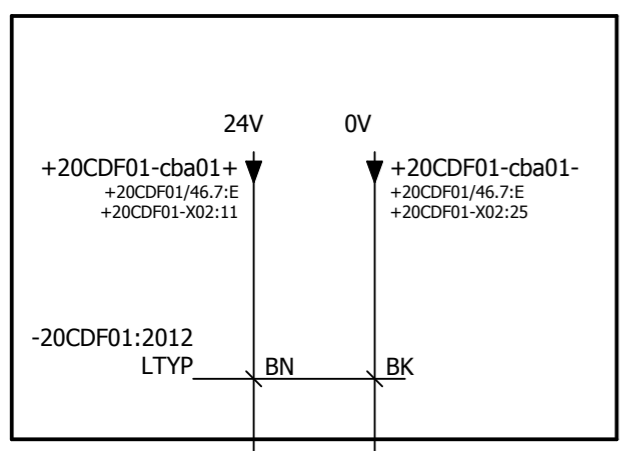

		Vypracoval Tomáš Sivok		Zákazník: Odvoz a likvidácia odpadu a.s.		<b>SIEMENS</b>		Hydr. pumpová stanica		=	
		Kontroloval Began		Zákazka: Riadenie rošta		SIEMENS s.r.o. „Lamačská cesta 3/A 841 04 Bratislava - SK		REV: 6/2016 PSV		+20CBA01	
		Schválil Began						Arch. číslo: P.02091.01		List 41	
Revizia	Dátum	Meno	Datum	6/2016			<b>Rozvádzač / Hydraulická pumpová stanica</b>		P.02091.01		Listov 4
1		2		3	4	5	6	7	8		

-A10.1  
/43.1:A  
Rack X  
Slot Y

6ES7131-6BF00-0BA0 + BU15-P16+A10+2D DI 8x24 VDC ST

SIEMENS

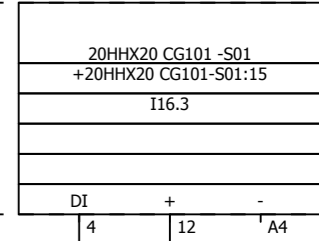
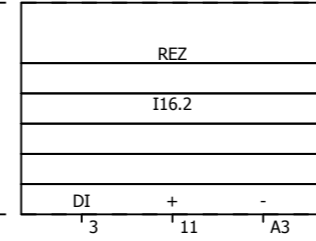
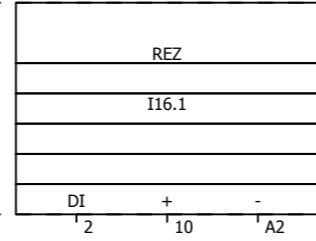
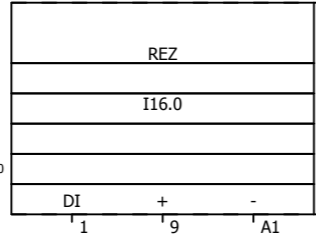
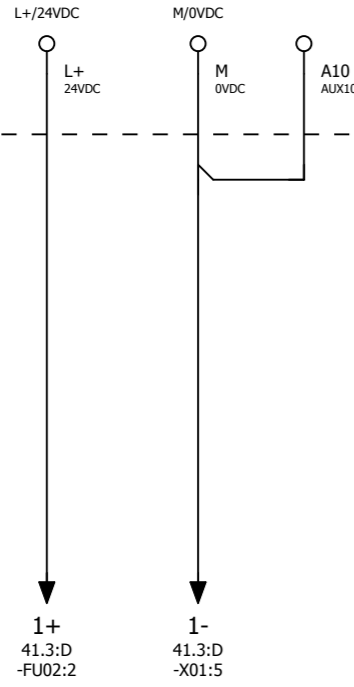

+20HHX20 CG101 -S01  
FANAC PS05 S11  
Mech. snímač koncovej polohy

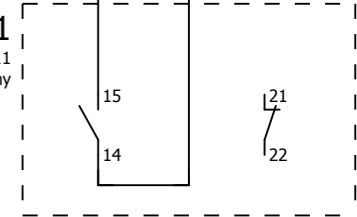

© Copyright SIEMENS s.r.o. 2015

			Vypracoval Tomáš Sivok
			Kontroloval Began
			Schválil Began
Revizia	Dátum	Meno	Datum 6/2016

Zákazník:	Odvoz a likvidácia odpadu a.s.
Zákazka:	Riadenie rošta

**SIEMENS**  
SIEMENS s.r.o. ,Lamačská cesta 3/A  
841 04 Bratislava - SK

**Hydr. pumpová stanica**  
  
**DI karta 1-4**

	=
REV: 6/2016 PSV	+20CBA01
Arch. číslo: P.02091.01	List 42
	Listov 4

-A10.1  
/42.1:A  
Rack X  
Slot Y

6ES7131-6BF00-0BA0 + BU15-P16+A10+2D DI 8x24 VDC ST

SIEMENS

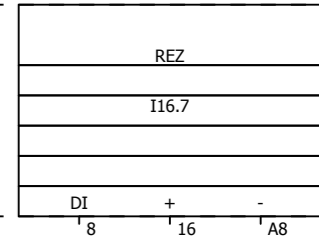
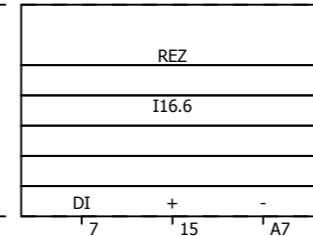
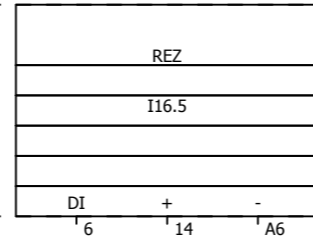
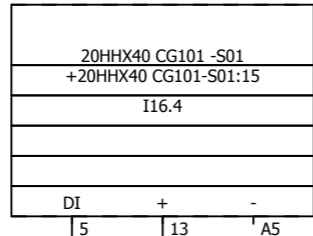

-20CBA01:5004  
801

BU BN RD

+20HHX40 CG101 -S01  
FANAC PS05 S11  
Mech. snímač koncovej polohy

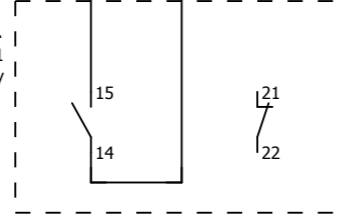

© Copyright SIEMENS s.r.o. 2015

			Vypracoval Tomáš Sivok
			Kontroloval Began
			Schválil Began
Revizia	Dátum	Meno	Datum 6/2016

Zákazník:	Odvoz a likvidácia odpadu a.s.
Zákazka:	<b>Riadenie rošta</b>

**SIEMENS**  
SIEMENS s.r.o. „Lamačská cesta 3/A  
841 04 Bratislava - SK

**Hydr. pumpová stanica**  
  
**DI karta 5-8**

	=
REV: 6/2016 PSV	+20CBA01
Arch. číslo: P.02091.01	List 43
	Listov 4

-A10.2  
Rack X  
Slot Y

6ES7134-6GD00-0BA1 + BU15-P16+A0+2B

AI 4xI 2-/4-wire ST

SIEMENS

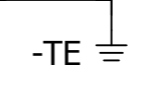
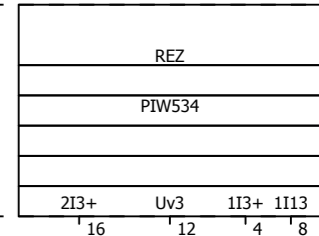
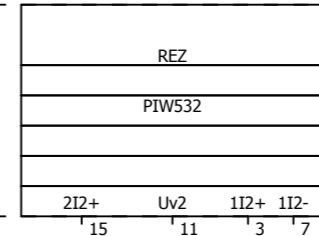
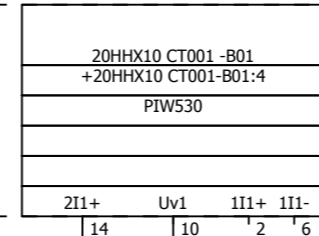
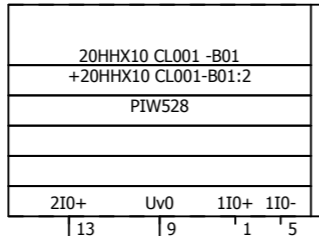
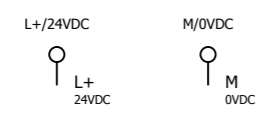

-20CBA01:6000  
801

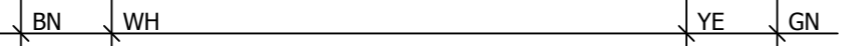

+20HHX10 CL001 -B01  
4-20mA = 0 - 300 mm  
Hladina oleja hydraulická nádrž

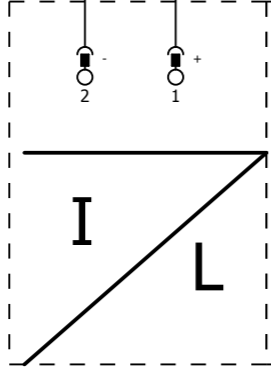

+20HHX10 CT001 -B01  
4-20mA = 0 - x st.C  
Teplota oleja hydraulická nádrž

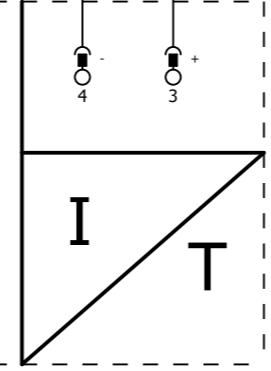

© Copyright SIEMENS s.r.o. 2015

			Vypracoval Tomáš Sivok
			Kontroloval Began
			Schválil Began
Revizia	Dátum	Meno	Datum 6/2016

Zákazník: Odvoz a likvidácia odpadu a.s.  
Zákazka: Riadenie rošta

**SIEMENS**  
SIEMENS s.r.o. ,Lamačská cesta 3/A  
841 04 Bratislava - SK

**Hydr. pumpová stanica**  
**AI karta**

		=
	REV: 6/2016 PSV	+20CBA01
	Arch. číslo: P.02091.01	List 44
		Listov 4



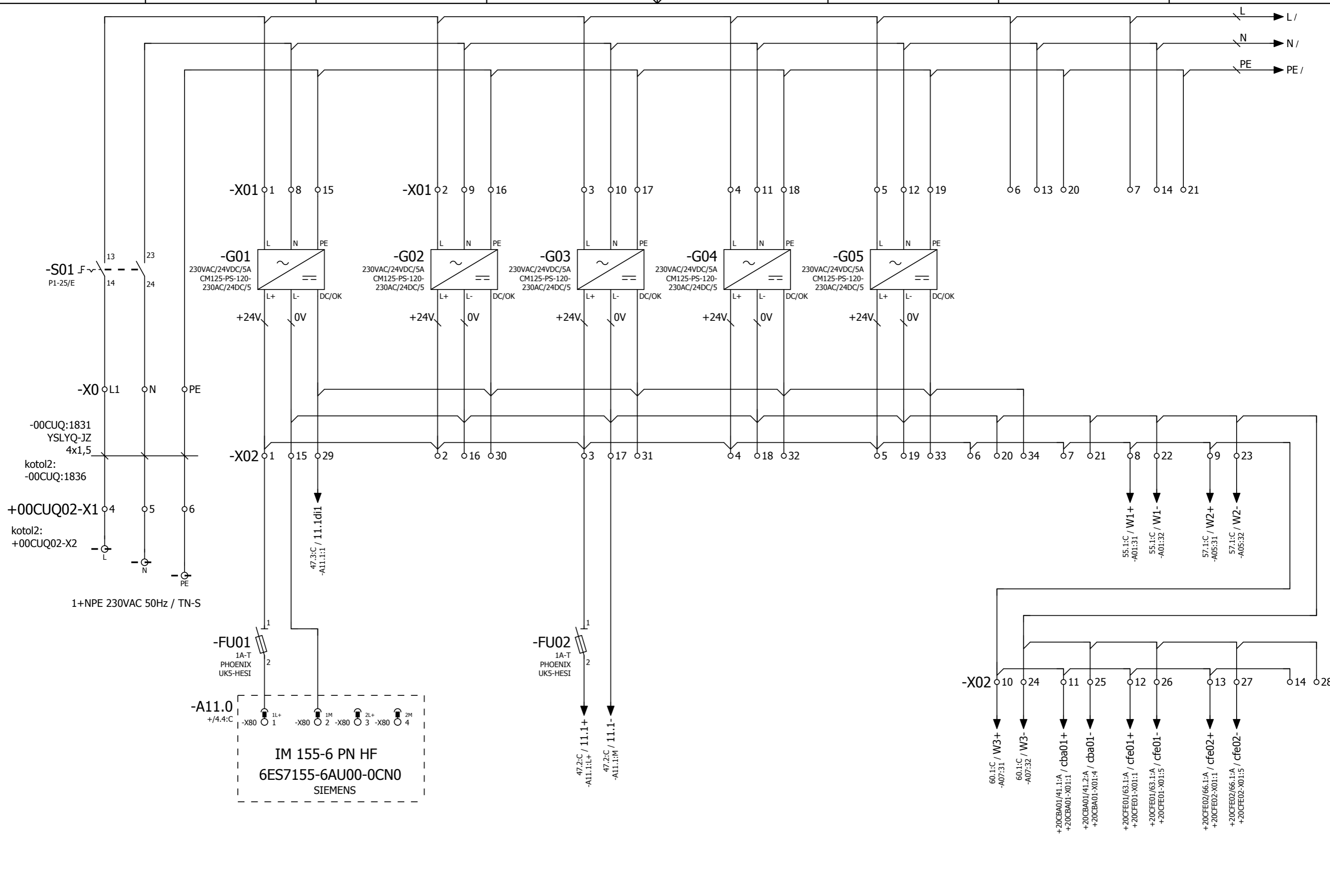

Revizia	Dátum	Meno	Datum
			6/2016

Vypracoval Tomáš Sivok Kontroloval Began Schválil Began	Zákazník: Odvoz a likvidácia odpadu a.s. Zákazka: Riadenie rošta
---	---

**SIEMENS**  
 SIEMENS s.r.o. ,Lamačská cesta 3/A  
 841 04 Bratislava - SK

**Rozvádzač/ Pomocné prístroje**  
**Napájanie 230V AC/ 24V DC**

REV: 6/2016 PSV	=
Arch. číslo: P.02091.01	+20CDF01
	List 46
	Listov 10

-A11.1  
/48.1:A  
Rack X  
Slot Y

6ES7131-6BF00-0BA0 + BU15-P16+A10+2D DI 8x24 VDC ST

SIEMENS

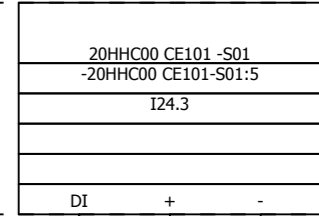
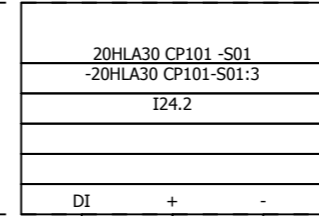
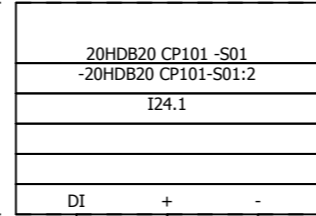
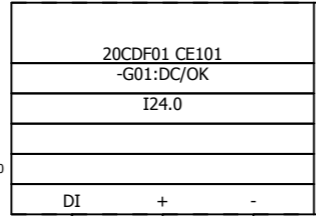
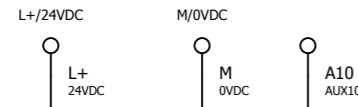

11.1+  
46.4:E  
-FU02:2

11.1-  
46.4:E  
-X02:17

46.3:D / 11.1:di1  
-X02:29

20CDF01 CE101

-20HHC00 CE101 -S01

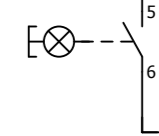

-20CDF01:5000  
801 BN BU

-20HDB20 CP101 -S01 [P]  
DE 3+/-1bar

-20CDF01:5040  
801 BN BU

-20HLA30 CP101 -S01 [P]  
Dwyer mod 1996-20

Revizia	Dátum	Meno	Datum	6/2016	Zákazník: Zákazka:	Odvoz a likvidácia odpadu a.s. Riadenie rošta	<b>SIEMENS</b> SIEMENS s.r.o. ,Lamačská cesta 3/A 841 04 Bratislava - SK	Rozvádzač/ Pomocné prístroje  <b>DI karta 1-4</b>	REV: 6/2016 PSV Arch. číslo: P.02091.01	= +20CDF01 List 47 Listov 10
1	2	3	4	5	6	7	8			

© Copyright SIEMENS s.r.o. 2015

-A11.1  
/47.1:A  
Rack X  
Slot Y

6ES7131-6BF00-0BA0 + BU15-P16+A10+2D DI 8x24 VDC ST

SIEMENS

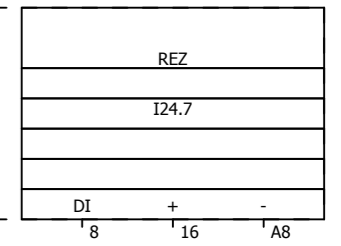
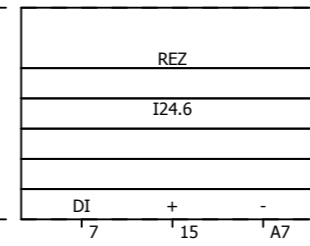
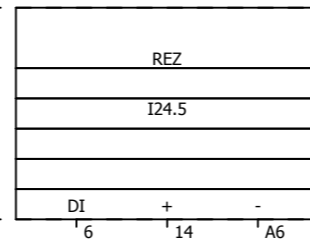
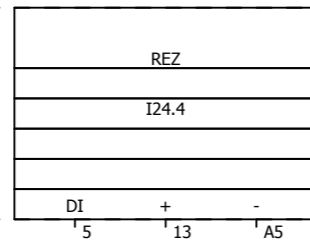

© Copyright SIEMENS s.r.o. 2015

A  
B  
C  
D  
E  
F

A  
B  
C  
D  
E  
F

Vypracoval Tomáš Sivok			Zákazník: Odvoz a likvidácia odpadu a.s.		<b>SIEMENS</b> SIEMENS s.r.o. „Lamačská cesta 3/A 841 04 Bratislava - SK	Rozvádzač/ Pomocné prístroje	REV: 6/2016 PSV	=
Kontroloval Began			Zákazka: Riadenie rošta					
Revizia	Dátum	Meno	Datum	6/2016	Arch. číslo: P.02091.01		List 48	
1	2	3	4	5	6	7	8	Listov 10

-A11.2  
 Rack X  
 Slot Y

6ES7132-6BD20-0BA0 + BU15-P16+A0+2B DQ 4x24 VDC/2A ST

SIEMENS

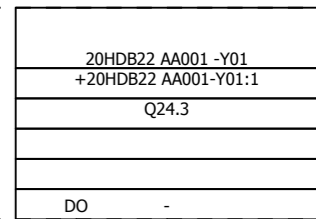
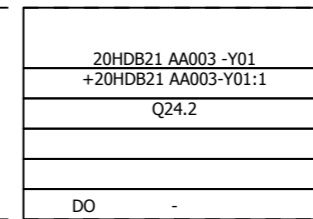
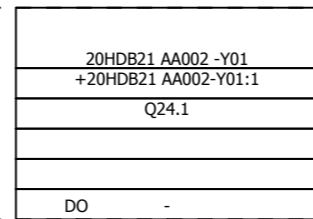
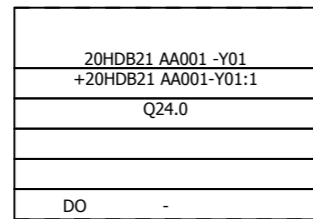
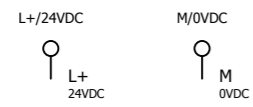

-20CDF01:5001  
 PVC-JZ  
 3x0,75

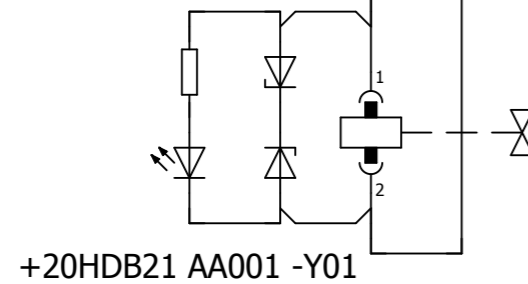

-20CDF01:5002  
 PVC-JZ  
 3x0,75

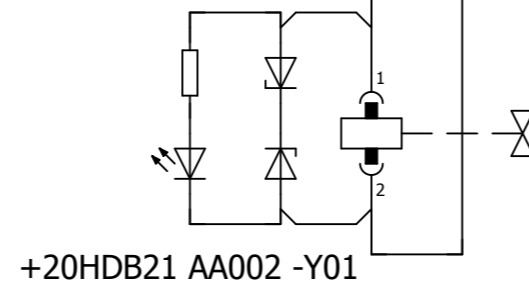

-20CDF01:5003  
 PVC-JZ  
 3x0,75

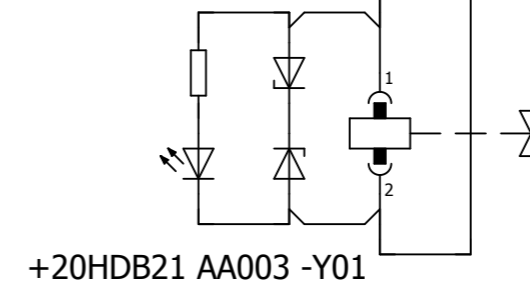

-20CDF01:5004  
 PVC-JZ  
 3x0,75

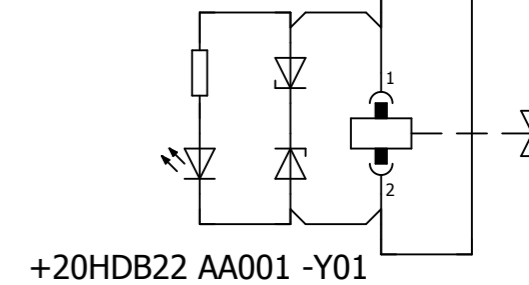

			Vypracoval Tomáš Sivok
			Kontroloval Began
			Schválil Began
Revizia	Dátum	Meno	Datum 6/2016
1		2	

Zákazník: Odvoz a likvidácia odpadu a.s.
Záказka: Ríadenie rošta
3
4

**SIEMENS**  
 SIEMENS s.r.o. ,Lamačská cesta 3/A  
 841 04 Bratislava - SK

**Rozvádzač/ Pomocné prístroje**  
**4DO karta**

REV: 6/2016 PSV  
 Arch. číslo: P.02091.01

=	+20CDF01
List	49
Listov	10

-A11.3  
Rack X  
Slot Y

6ES7132-6BD20-0BA0 + BU15-P16+A0+2B DQ 4x24 VDC/2A ST

SIEMENS

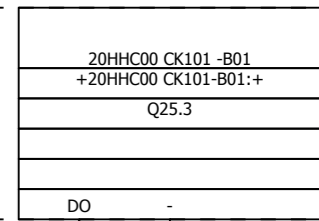
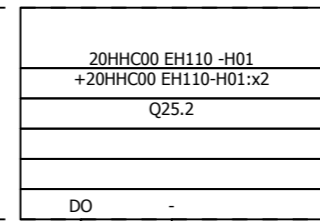
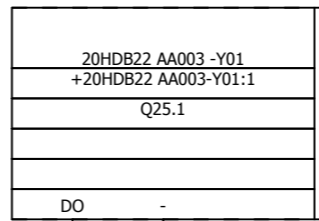
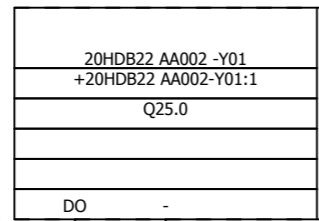
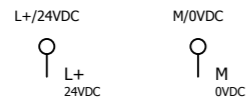

1 9

2 10

3 11

4 12

+20HHC00 EH110 -H01

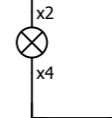

+20HHC00 CK101 -B01  
BAUSER 665 7

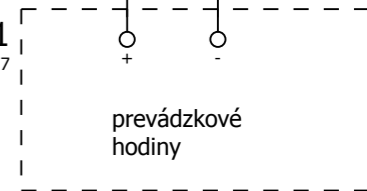

-20CDF01:5005  
PVC-JZ  
3x0,75

+20HDB22 AA002 -Y01

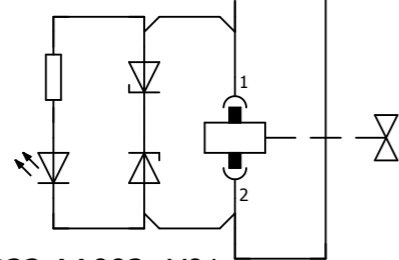

-20CDF01:5006  
PVC-JZ  
3x0,75

+20HDB22 AA003 -Y01

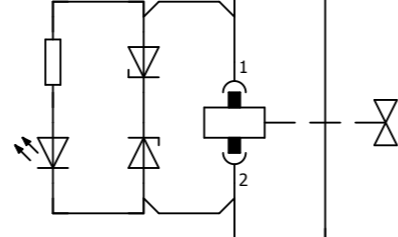

© Copyright SIEMENS s.r.o. 2015

Revízia	Dátum	Meno	Vypracoval Tomáš Sivok
			Kontroloval Began
			Schválil Began
			Datum 6/2016

Zákazník:	Odvoz a likvidácia odpadu a.s.
Zákazka:	Riadenie rošta

**SIEMENS**  
SIEMENS s.r.o. , Lamačská cesta 3/A  
841 04 Bratislava - SK

**Rozvádzač/ Pomocné prístroje**  
**4DO karta**

REV: 6/2016 PSV	=
Arch. číslo: P.02091.01	+20CDF01

List	50
Listov	10

-A11.4  
 Rack X  
 Slot Y

6ES7132-6BD20-0BA0 + BU15-P16+A0+2D DQ 4x24 VDC/2A ST

SIEMENS

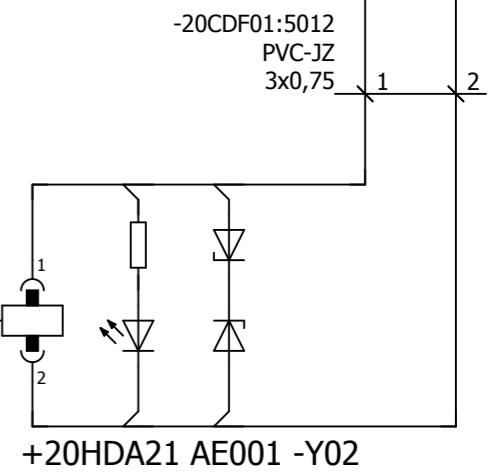
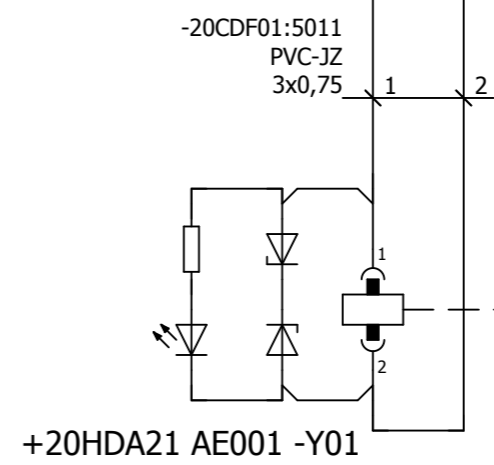
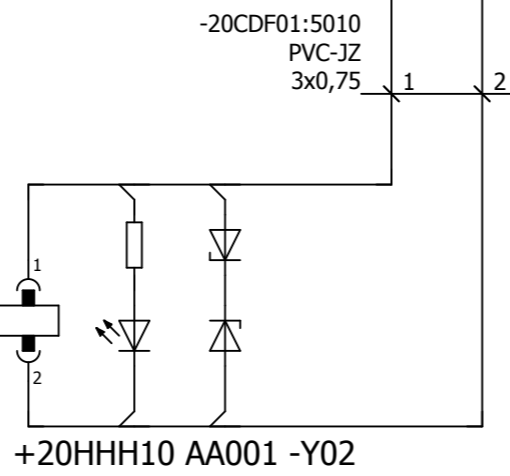
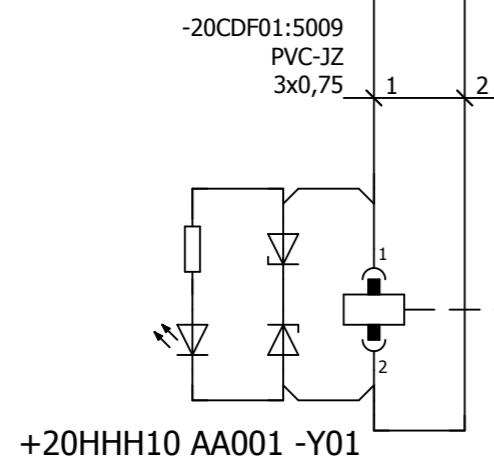
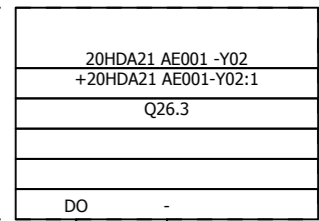
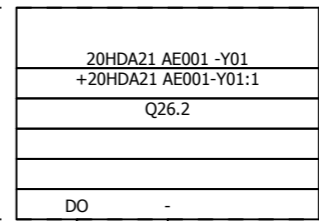
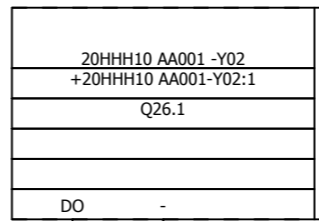
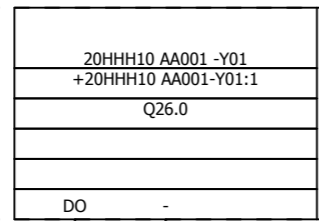
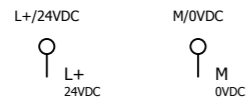

Revizia	Dátum	Meno	Datum
		Schválil	6/2016
		Kontroloval	
		Vypracoval	

Zákazník:	Odvoz a likvidácia odpadu a.s.
Zákazka:	Riadenie rošta

**SIEMENS**  
 SIEMENS s.r.o. ,Lamačská cesta 3/A  
 841 04 Bratislava - SK

**Rozvádzač/ Pomocné prístroje**  
**4DO karta**

REV: 6/2016 PSV	=
Arch. číslo: P.02091.01	+20CDF01
	List 51
	Listov 10

© Copyright SIEMENS s.r.o. 2015

-A11.5  
Rack X  
Slot Y

6ES7132-6HD00-0BB1 + BU20-P12+A0+4B

RQ 4x120VDC-230VAC/5A NO ST

SIEMENS

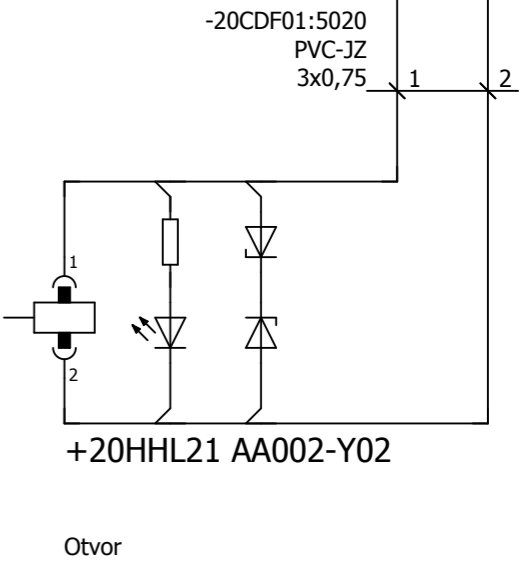
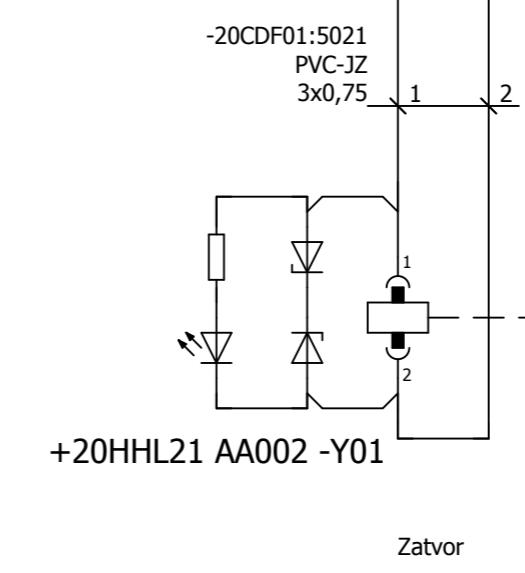
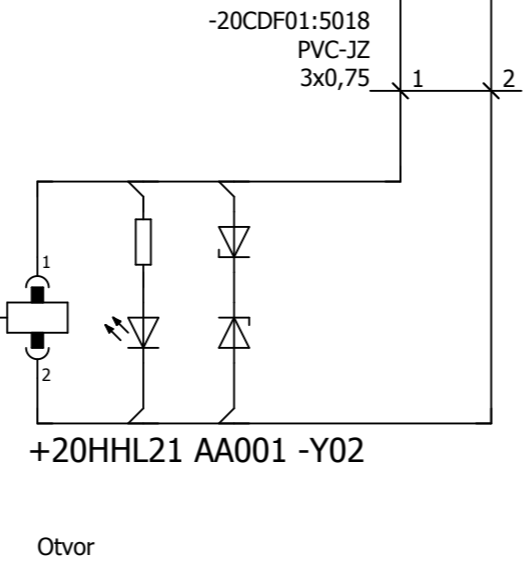
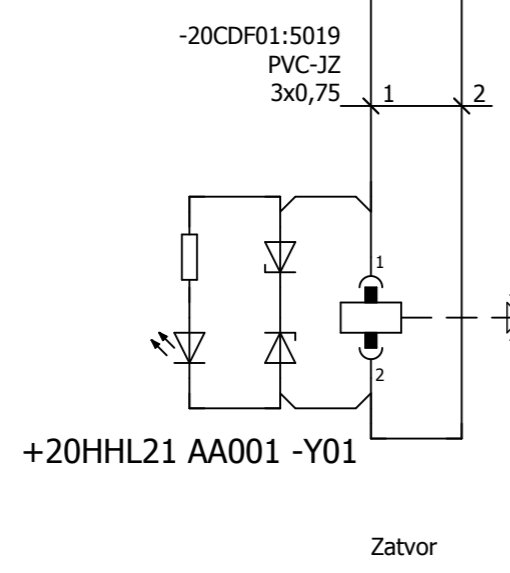
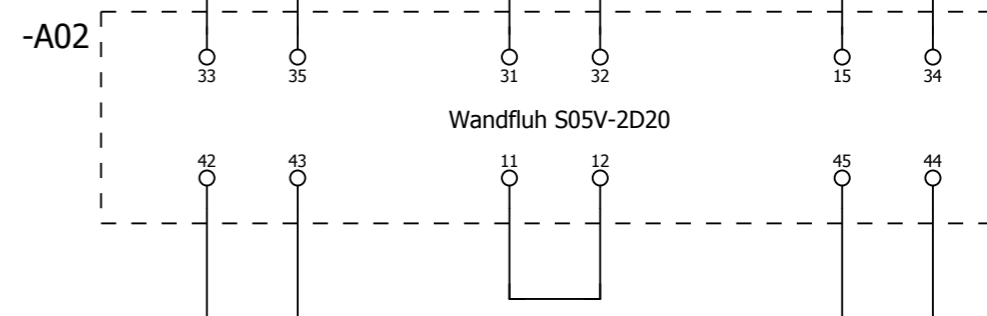
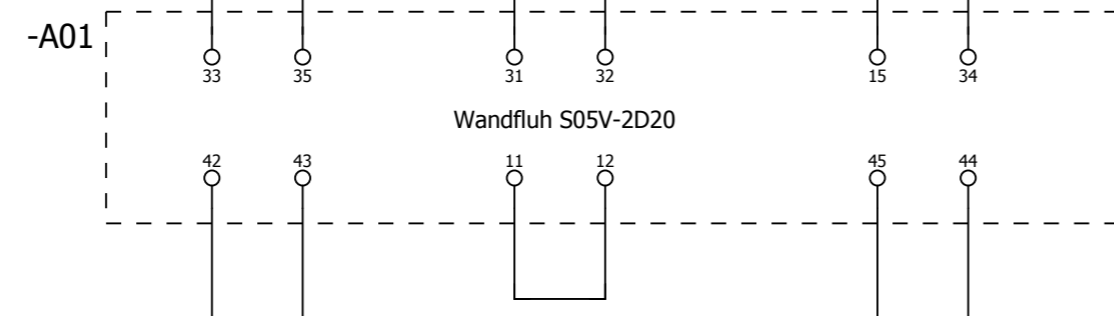
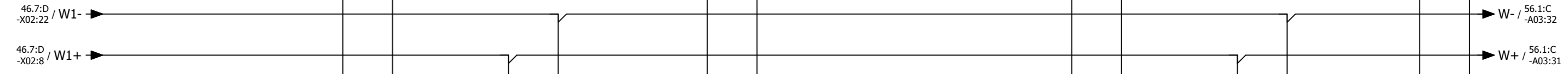
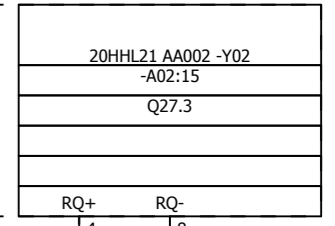
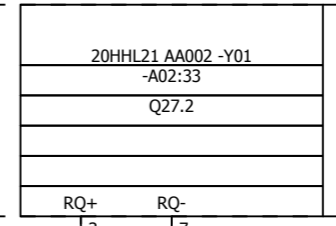
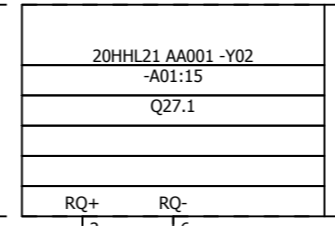
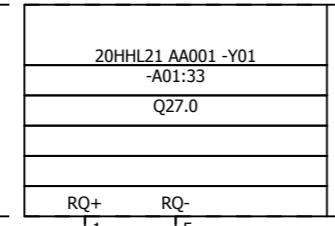

Revizia	Dátum	Meno	Vypracoval Tomáš Sivok
			Kontroloval Began
			Schválil Began
			Datum 6/2016

Zákazník:	Odvoz a likvidácia odpadu a.s.
Zákazka:	Riadenie rošta

**SIEMENS**  
SIEMENS s.r.o. , Lamačská cesta 3/A  
841 04 Bratislava - SK

**Rozvádzač/ Pomocné prístroje**  
**4DO-R karta**

REV: 6/2016 PSV	=
Arch. číslo: P.02091.01	+20CDF01
	List 55
	Listov 10

-A11.6  
Rack X  
Slot Y

6ES7132-6HD00-0BB1 + BU20-P12+A0+4B

RQ 4x120VDC-230VAC/5A NO ST

SIEMENS



55.8:C / W-  
-A02:32

55.8:C / W+  
-A02:31

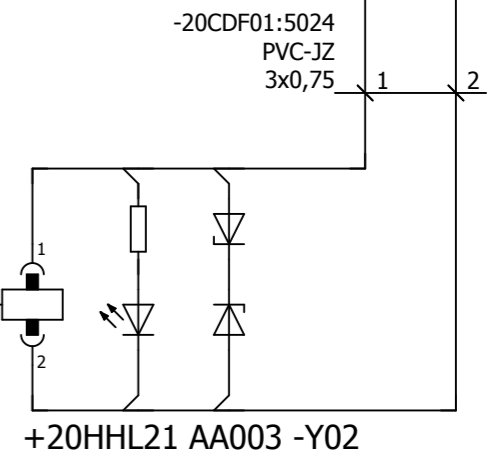
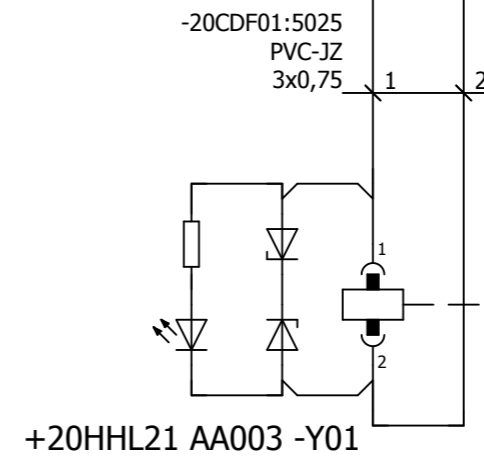
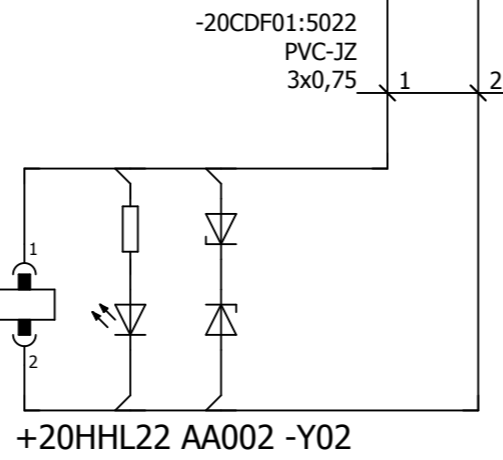
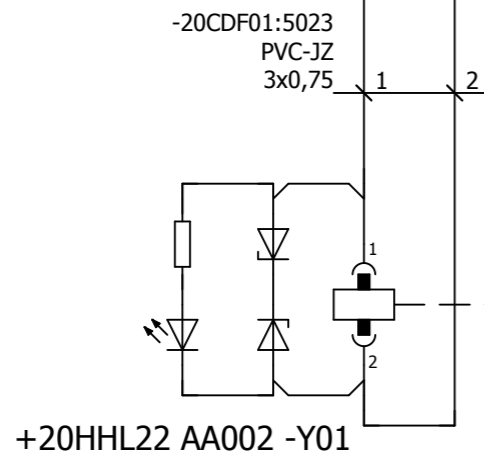
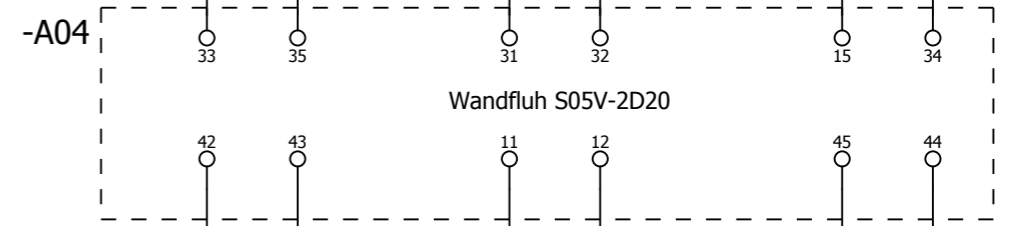
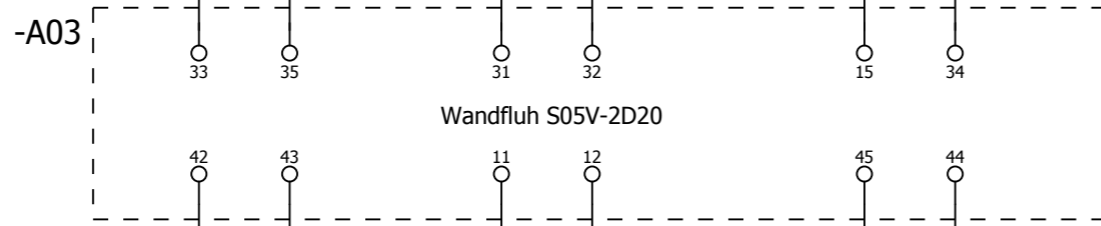

Zatvor

Otvor

Zatvor

Otvor

			Vypracoval Tomáš Sivok
			Kontroloval Began
			Schválil Began
Revizia	Dátum	Meno	Datum 6/2016

Zákazník: Odvoz a likvidácia odpadu a.s.  
Zákazka: Riadenie rošta

**SIEMENS**  
SIEMENS s.r.o. , Lamačská cesta 3/A  
841 04 Bratislava - SK

**Rozvádzač/ Pomocné prístroje**  
**4DO-R karta**

	=
REV: 6/2016 PSV	+20CDF01
Arch. číslo: P.02091.01	List 56
	Listov 10



-A11.7  
Rack X  
Slot Y

6ES7132-6HD00-0BB1 + BU20-P12+A0+4B

RQ 4x120VDC-230VAC/5A NO ST

SIEMENS

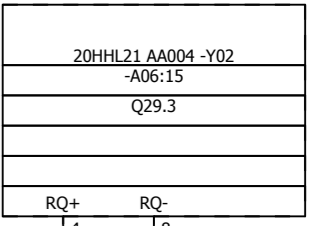
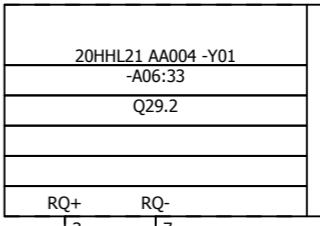
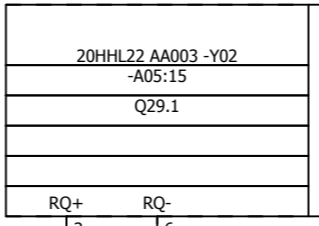
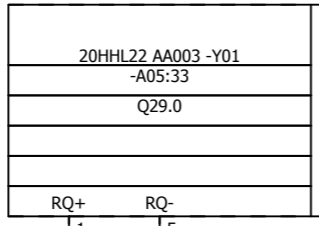

46.8:D  
-X02:23 / W2-  
46.8:D  
-X02:9 / W2+

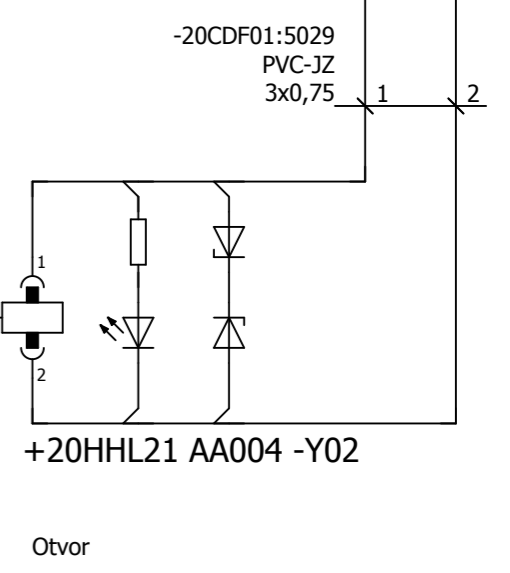
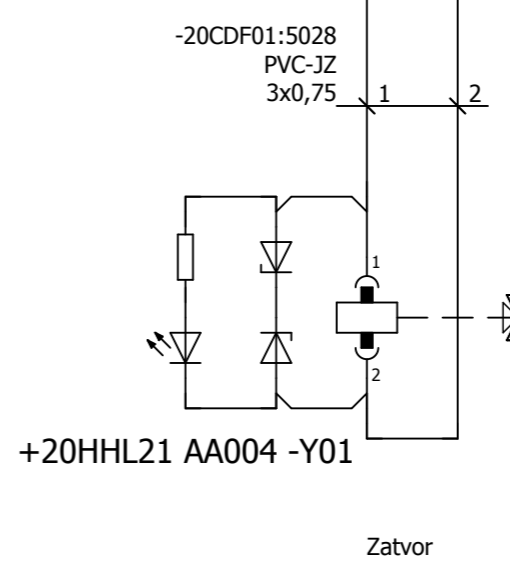
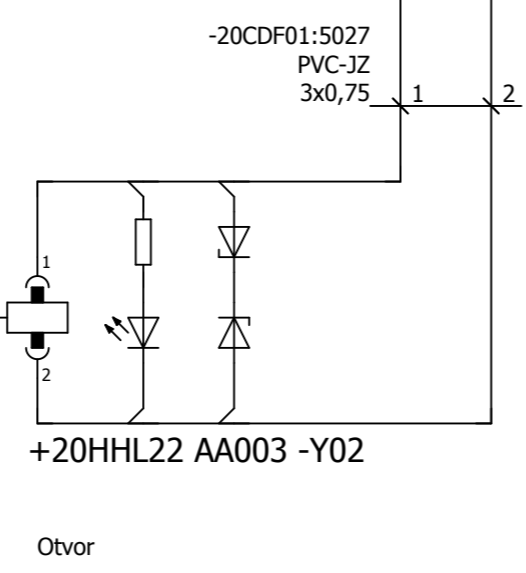
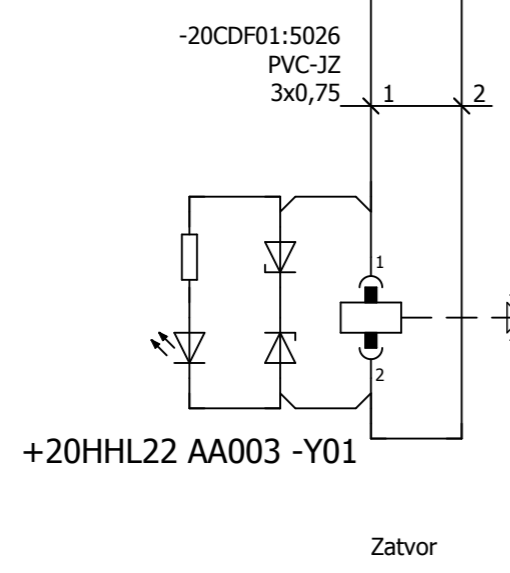
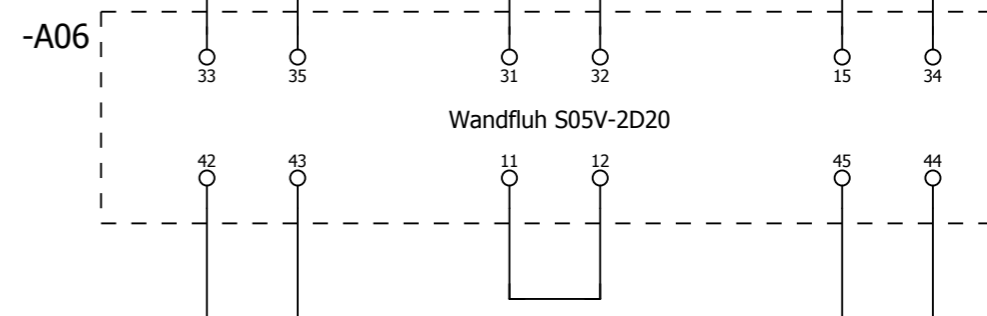
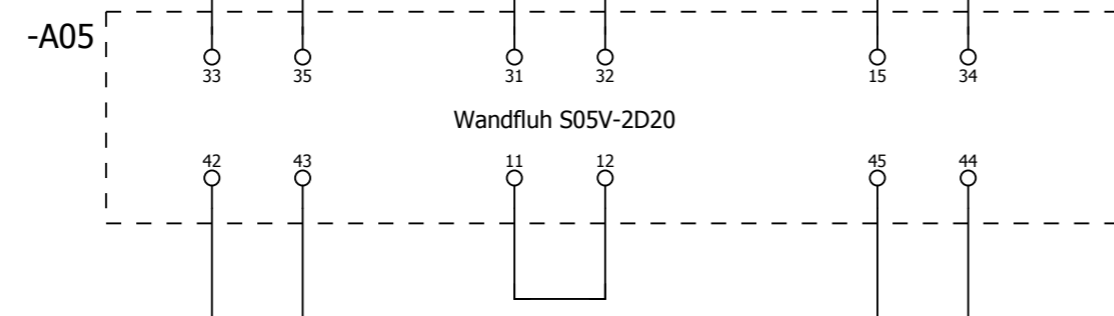

Revizia	Dátum	Meno	Datum	6/2016
		Schválil	Began	
		Kontroloval	Began	
		Vypracoval	Tomáš Sivok	

Zákazník:	Odvoz a likvidácia odpadu a.s.
Zákazka:	Riadenie rošta

**SIEMENS**  
SIEMENS s.r.o. , Lamačská cesta 3/A  
841 04 Bratislava - SK

**Rozvádzač/ Pomocné prístroje**  
**4DO-R karta**

REV: 6/2016 PSV	=
Arch. číslo: P.02091.01	+20CDF01

List	57
Listov	10

© Copyright SIEMENS s.r.o. 2015

-A11.8  
Rack X  
Slot Y

6ES7132-6HD00-0BB1 + BU20-P12+A0+4B

RQ 4x120VDC-230VAC/5A NO ST

SIEMENS

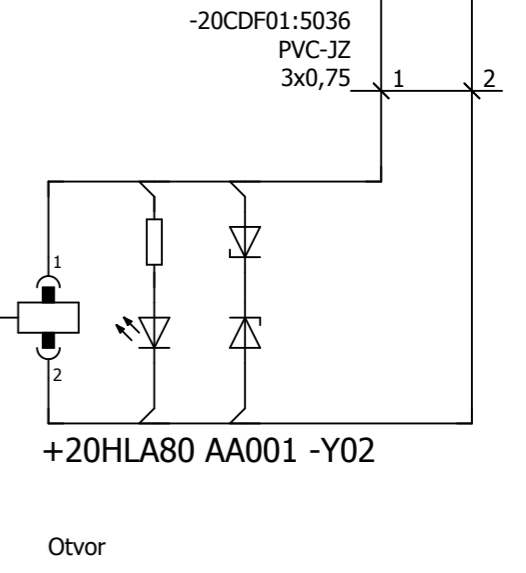
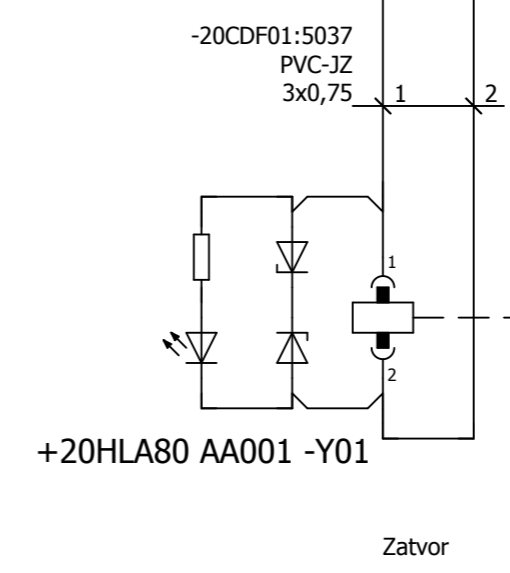
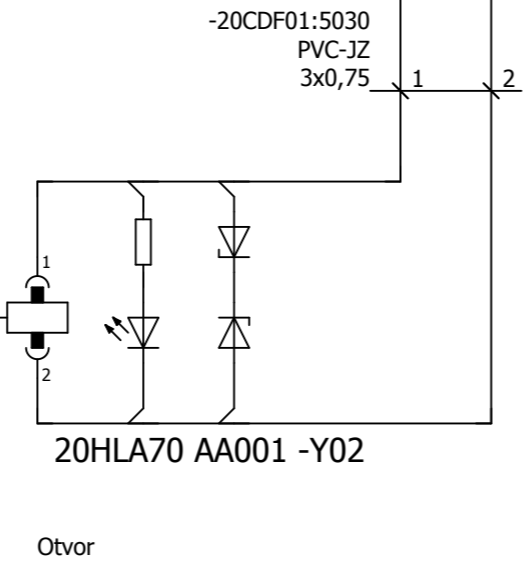
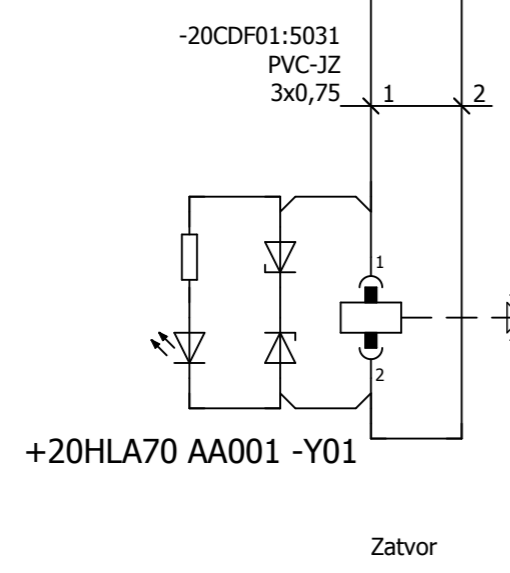
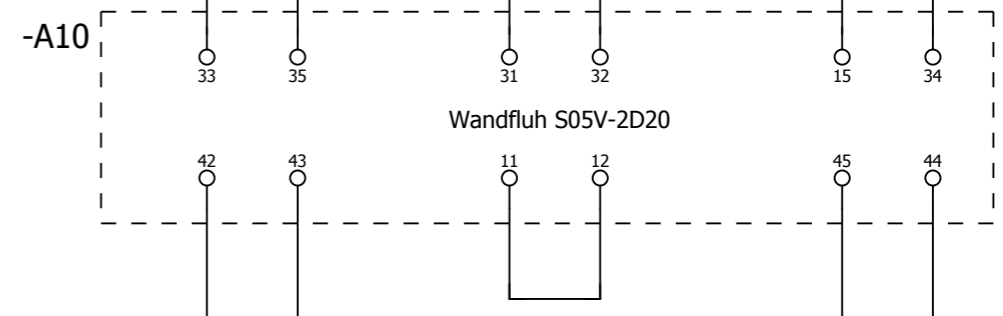
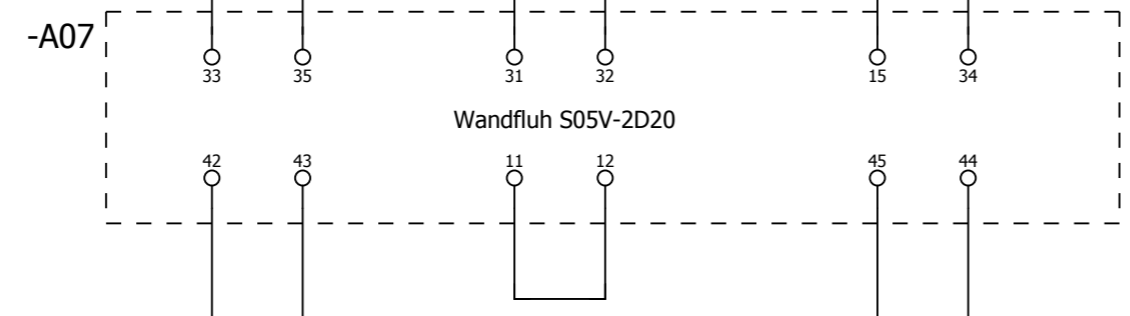
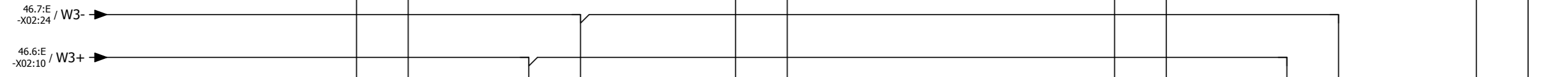
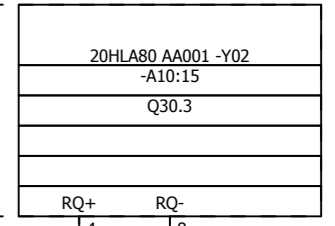
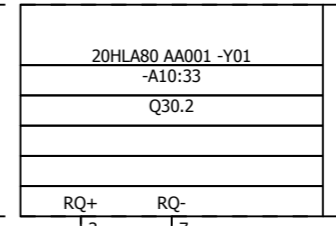
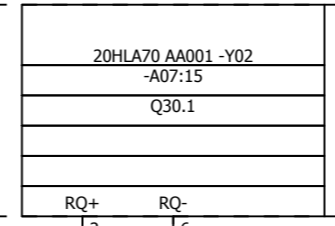
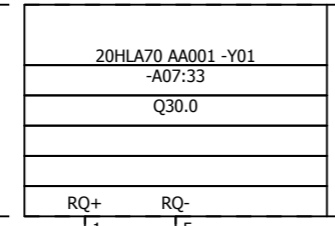

Revizia	Dátum	Meno	Datum	6/2016
		Schválil	Began	
		Kontroloval	Began	
		Vypracoval	Tomáš Sivok	

Zákazník:	Odvoz a likvidácia odpadu a.s.
Zákazka:	Riadenie rošta

**SIEMENS**  
SIEMENS s.r.o. , Lamačská cesta 3/A  
841 04 Bratislava - SK

**Rozvádzač/ Pomocné prístroje**  
**4DO-R karta**

REV: 6/2016 PSV	=
Arch. číslo: P.02091.01	+20CDF01
	List 60
	Listov 10

© Copyright SIEMENS s.r.o. 2015

© Copyright SIEMENS s.r.o. 2015

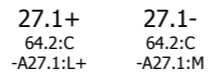
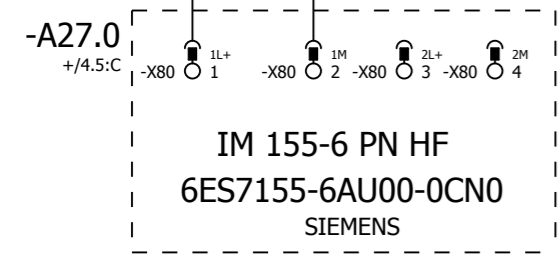
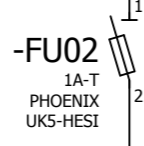
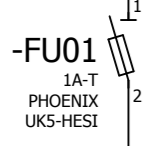
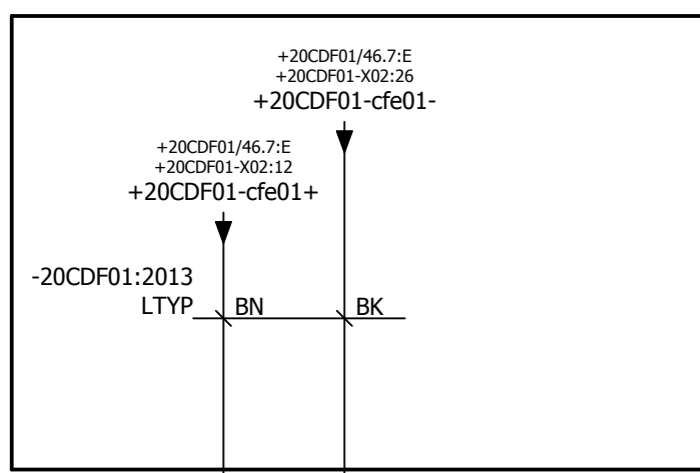

			Vypracoval Tomáš Sivok Kontroloval Began Schválil Began Datum 6/2016
Revizia	Dátum	Meno	

Zákazník:	Odvoz a likvidácia odpadu a.s.
Zákazka:	Riadenie rošta

**SIEMENS**  
 SIEMENS s.r.o. „Lamačská cesta 3/A  
 841 04 Bratislava - SK

**Rozvádzač/ Tlak v pásmoch rošta**  
**Napájanie 24V DC**

REV: 6/2016 PSV	=
Arch. číslo: P.02091.01	+20CFE01
	List 63
	Listov 3

-A27.1  
Rack X  
Slot Y

6ES7134-6GD00-0BA1 + BU15-P16+A0+2D

AI 4xI 2-/4-wire ST

SIEMENS

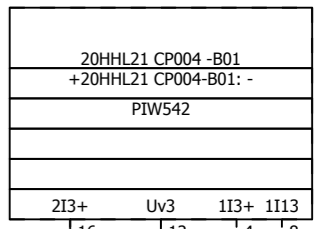
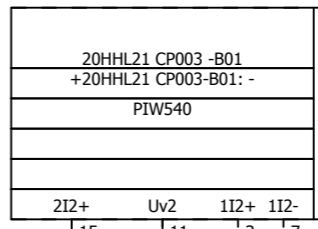
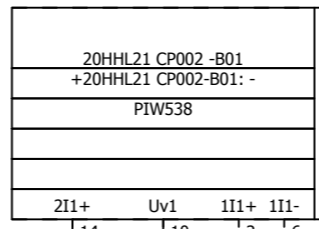
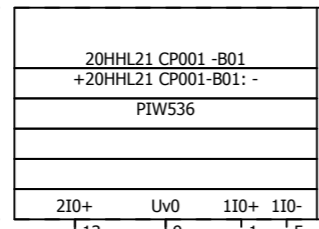
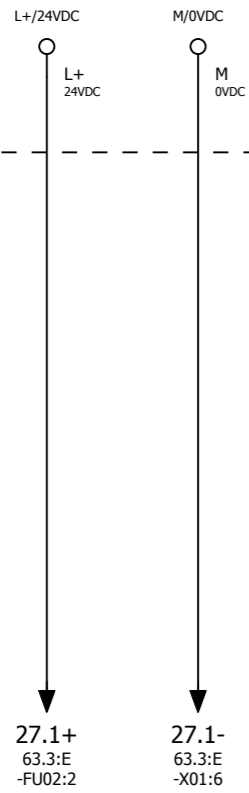

-TE

-TE

-TE

-TE

-20CFE01:6000  
Unitronics LiYCY  
2x0,34

-20CFE01:6001  
Unitronics LiYCY  
2x0,34

-20CFE01:6002  
Unitronics LiYCY  
2x0,34

-20CFE01:6003  
Unitronics LiYCY  
2x0,34

+20HHL21 CP001 -B01  
4-20mA = 0 - 60 mbar  
Siemens Sitrans P 7MF4013  
Tlak primárny vzduch rošt 1 pásmo 1

+20HHL21 CP002 -B01  
4-20mA = 0 - 60 mbar  
Siemens Sitrans P 7MF4013  
Tlak primárny vzduch rošt 1 pásmo 2

+20HHL21 CP003 -B01  
4-20mA = 0 - 60 mbar  
Siemens Sitrans P 7MF4013  
Tlak primárny vzduch rošt 1 pásmo 3

+20HHL21 CP004 -B01  
4-20mA = 0 - 60 mbar  
Siemens Sitrans P 7MF4013  
Tlak primárny vzduch rošt 1 pásmo 4

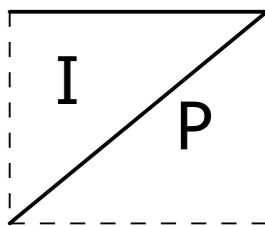
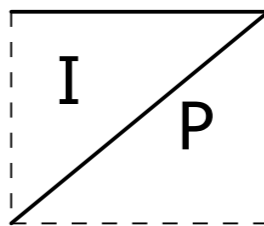
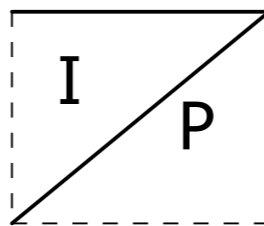
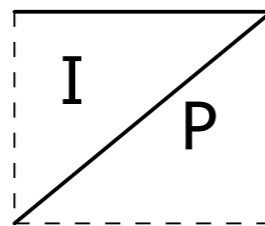

© Copyright SIEMENS s.r.o. 2015

Revizia	Dátum	Meno	Datum	6/2016
		Schválil	Began	
		Kontroloval	Began	
		Vypracoval	Tomáš Sivok	

Zákazník:	Odvoz a likvidácia odpadu a.s.
Zákazka:	Riadenie rošta

**SIEMENS**  
SIEMENS s.r.o. „Lamačská cesta 3/A  
841 04 Bratislava - SK

**Rozvádzač/ Tlak v pásmoch rošta**  
**AI karta**

REV: 6/2016 PSV	=
Arch. číslo: P.02091.01	+20CFE01
	List 64
	Listov 3

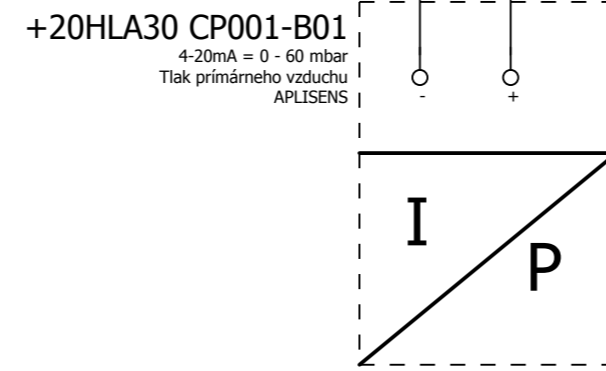
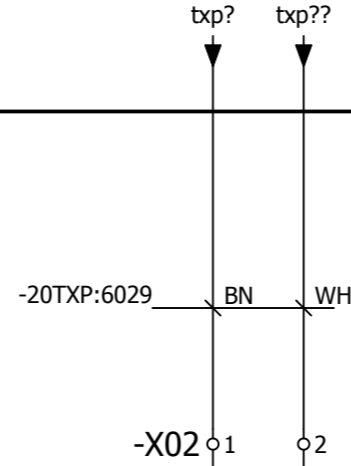
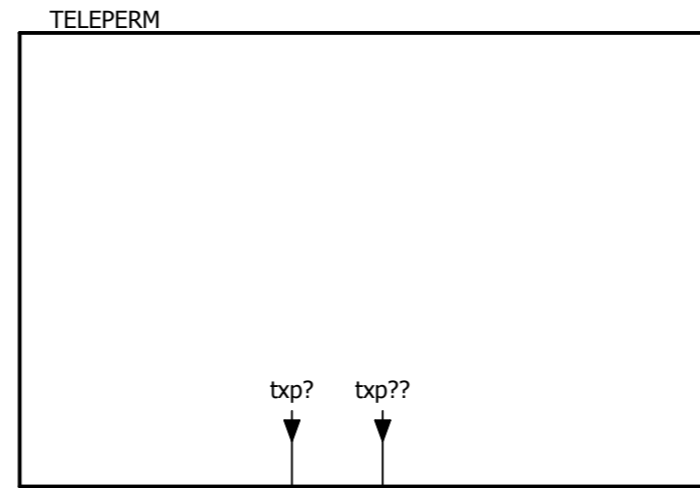

			Vypracoval Tomáš Sivok Kontroloval Began Schválil Began	Zákazník: Odvoz a likvidácia odpadu a.s. Zákazka: <b>Riadenie rošta</b>	<b>SIEMENS</b> SIEMENS s.r.o. ,Lamačská cesta 3/A 841 04 Bratislava - SK	<b>Rozvádzač/ Tlak v pásmoch rošta</b>  <b>Tlak do Telepermu</b>	= REV: 6/2016 PSV Arch. číslo: P.02091.01	+20CFE01 List 65 Listov 3
Revizia	Dátum	Meno	Datum	6/2016				

© Copyright SIEMENS s.r.o. 2015

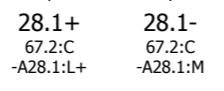
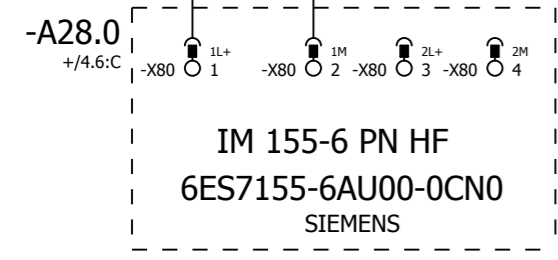
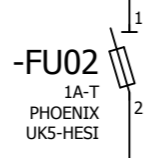
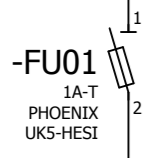
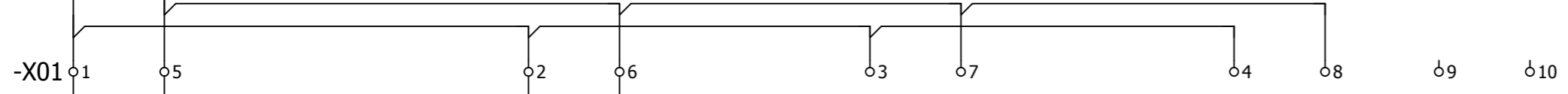
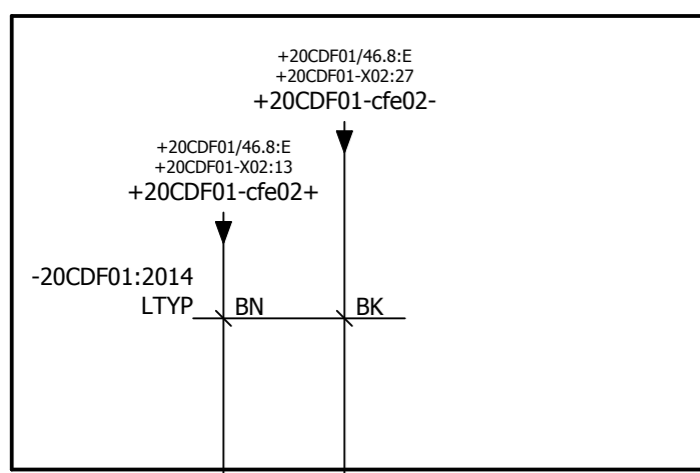

			Vypracoval Tomáš Sivok Kontroloval Began Schválil Began Datum 6/2016
Revizia	Dátum	Meno	

Zákazník:	Odvoz a likvidácia odpadu a.s.
Zákazka:	<b>Riadenie rošta</b>

**SIEMENS**  
 SIEMENS s.r.o. „Lamačská cesta 3/A“  
 841 04 Bratislava - SK

**Rozvádzač/ Tlak v pásmoch rošta**  
**Napájanie 24V DC**

REV: 6/2016 PSV	=
Arch. číslo: P.02091.01	+20CFE02
	List 66
	Listov 2

-A28.1  
Rack X  
Slot Y

6ES7134-6GD00-0BA1 + BU15-P16+A0+2D

AI 4xI 2-/4-wire ST

SIEMENS

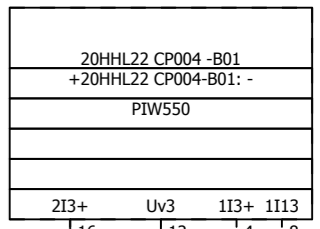
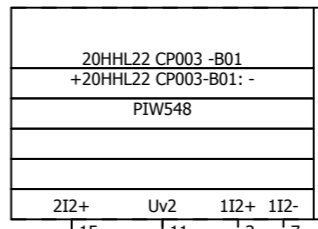
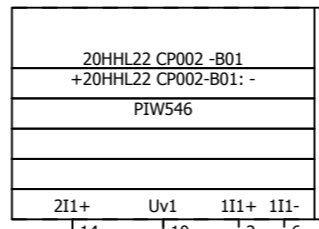
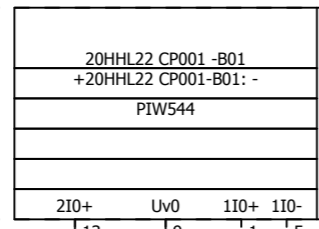
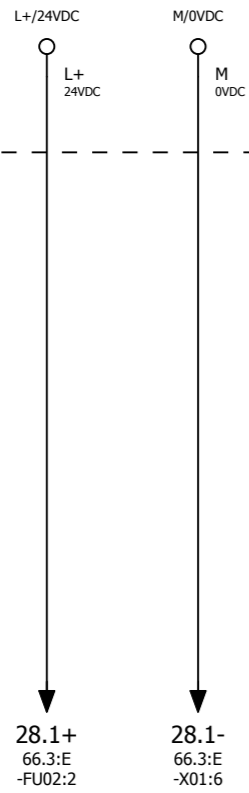

-TE

-TE

-TE

-TE

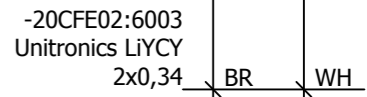
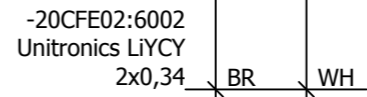
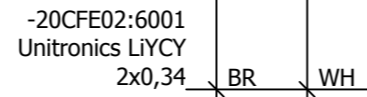
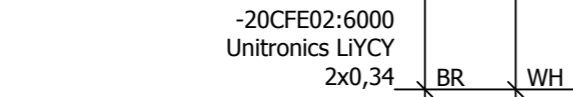

**+20HHL22 CP001 -B01**  
4-20mA = 0 - 60 mbar  
Siemens Sitrans P 7MF4013  
Tlak primárny vzduch rošt 2 pásmo 1

**+20HHL22 CP002 -B01**  
4-20mA = 0 - 60 mbar  
Siemens Sitrans P 7MF4013  
Tlak primárny vzduch rošt 2 pásmo 2

**+20HHL22 CP003 -B01**  
4-20mA = 0 - 60 mbar  
Siemens Sitrans P 7MF4013  
Tlak primárny vzduch rošt 2 pásmo 3

**+20HHL22 CP004 -B01**  
4-20mA = 0 - 60 mbar  
Siemens Sitrans P 7MF4013  
Tlak primárny vzduch rošt 1 pásmo 4

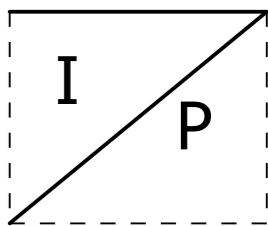
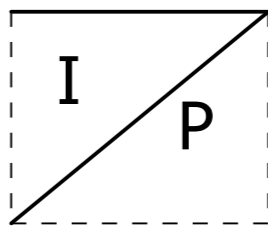
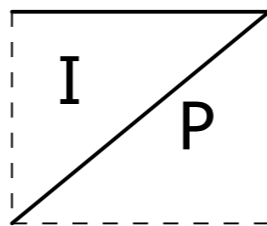
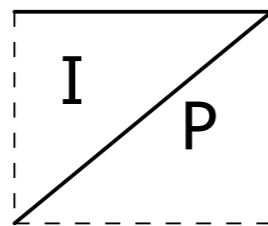

Revizia	Dátum	Meno	Datum	6/2016
		Schválil	Began	
		Kontroloval	Began	
		Vypracoval	Tomáš Sivok	

Zákazník:	Odvoz a likvidácia odpadu a.s.
Zákazka:	Riadenie rošta

**SIEMENS**  
SIEMENS s.r.o. „Lamačská cesta 3/A  
841 04 Bratislava - SK

**Rozvádzač/ Tlak v pásmoch rošta**  
**AI karta**

REV: 6/2016 PSV	=
Arch. číslo: P.02091.01	+20CFE02
	List 67
	Listov 2

© Copyright SIEMENS s.r.o. 2015

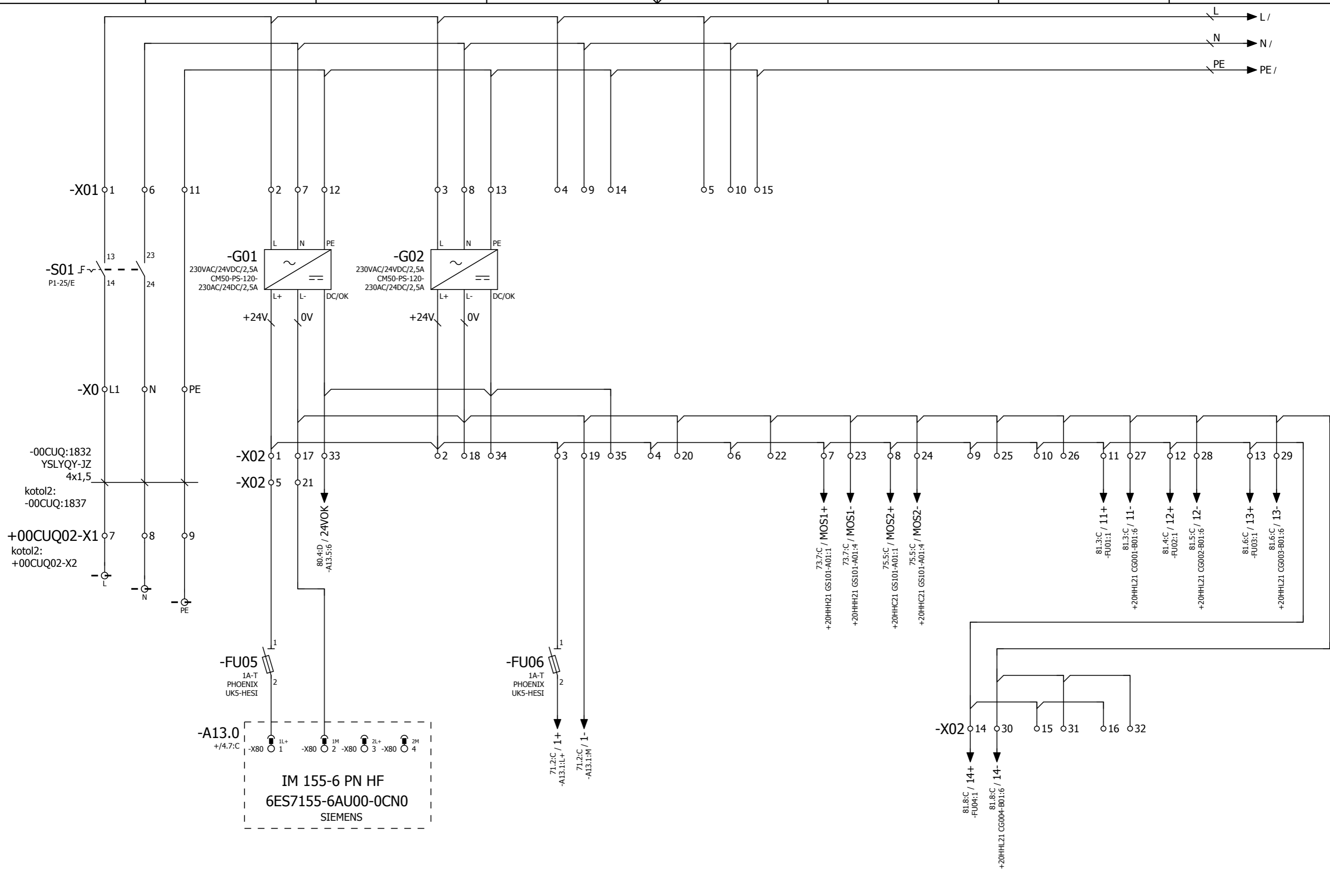

			Vypracoval Tomáš Sivok
			Kontroloval Began
			Schválil Began
Revizia	Dátum	Meno	Datum 6/2016

Zákazník:	Odvoz a likvidácia odpadu a.s.
Zákazka:	Riadenie rošta

**SIEMENS**  
SIEMENS s.r.o. „Lamačská cesta 3/A  
841 04 Bratislava - SK

**Rozvádzač / Roštová dráha 1**  
**Napájanie 230V AC/ 24V DC**

REV: 6/2016 PSV	=
Arch. číslo: P.02091.01	+20CBB01
	List 68
	Listov 12



-A13.1  
/72.1:A  
Rack X  
Slot Y

6ES7132-6BF00-0BA0 + BU15-P16+A0+2D DQ 8x24 VDC/0,5A ST

SIEMENS

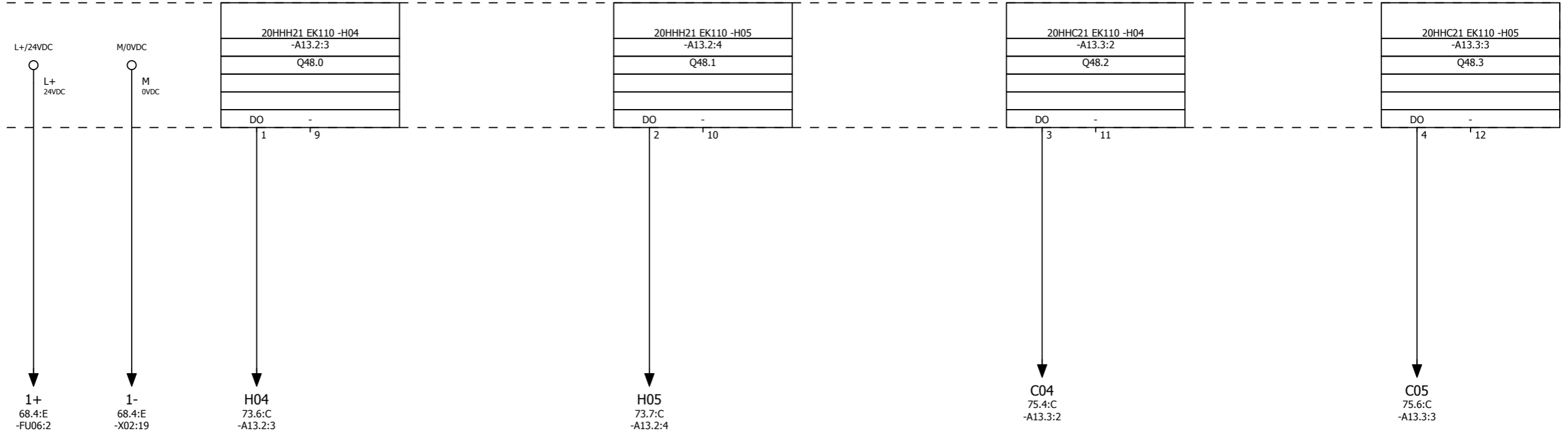

© Copyright SIEMENS s.r.o. 2015

Revizia	Dátum	Meno	Datum
			6/2016

Vypracoval	Tomáš Sivok	Zákazník:	Odvoz a likvidácia odpadu a.s.
Kontroloval	Began	Zákazka:	<b>Riadenie rošta</b>
Schválil	Began		

**SIEMENS**  
SIEMENS s.r.o. „Lamačská cesta 3/A  
841 04 Bratislava - SK

**Rozvádzač / Roštová dráha 1**  
**4DO karta**

REV: 6/2016 PSV	=
Arch. číslo: P.02091.01	+20CBB01
	List 71
	Listov 12

-A13.1  
/71.1:A  
Rack X  
Slot Y

6ES7132-6BF00-0BA0 + BU15-P16+A0+2D DQ 8x24 VDC/0,5A ST

SIEMENS

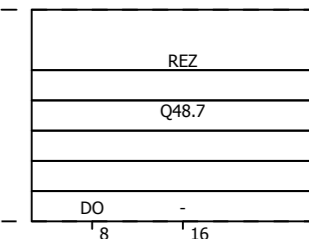
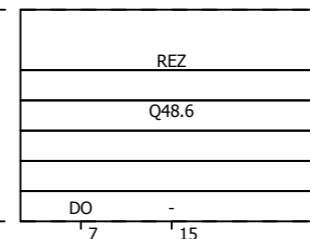
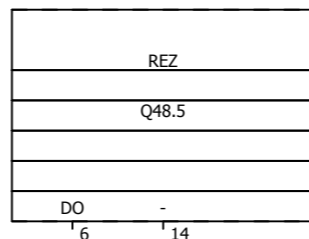
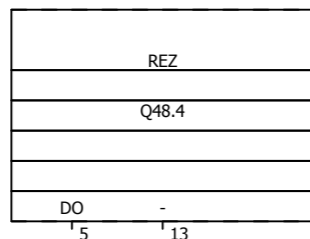

© Copyright SIEMENS s.r.o. 2015

Revizia	Dátum	Meno	Datum	6/2016

Zákazník:	Odvoz a likvidácia odpadu a.s.
Zákazka:	<b>Riadenie rošta</b>

**SIEMENS**  
SIEMENS s.r.o. ,Lamačská cesta 3/A  
841 04 Bratislava - SK

**Rozvádzač / Roštová dráha 1**  
  
**4DO karta**

REV: 6/2016 PSV		=
Arch. číslo: P.02091.01		+20CBB01
		List 72
		Listov 12

© Copyright SIEMENS s.r.o. 2015

-A13.2  
/74.1:A  
Rack X  
Slot Y

6ES7131-6BF00-0BA0 + BU15-P16+A10+2B DI 8x24 VDC ST

SIEMENS

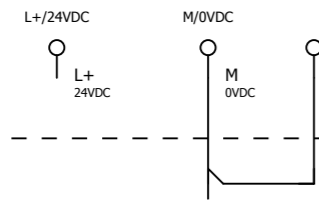

20HHH21 CG101 -S01
+20HHH21 CG101-S01:4
I48.0
DI + -
1 9 A1

20HHH21 CG102 -S01
+20HHH21 CG102-S01:4
I48.1
DI + -
2 10 A2

20HHH21 GS101 -S04
+20HHH21 GS101-A01:7
I48.2
DI + -
3 11 A3

20HHH21 GS101 -S05
+20HHH21 GS101-A01:8
I48.3
DI + -
4 12 A4

-20CBB01:5001  
801 GY BU RD

-20CBB01:5002  
801 GY BU RD

-20CBB01:5003  
/74.3:D  
802 GY BU RD YE

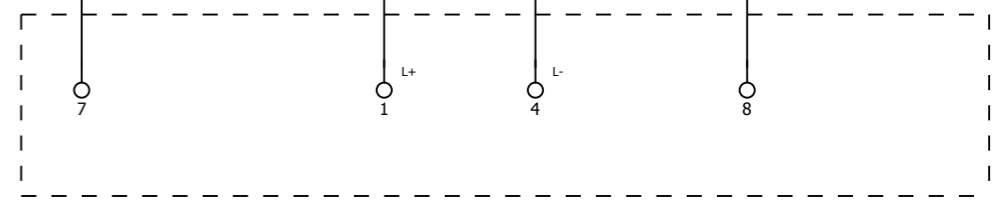
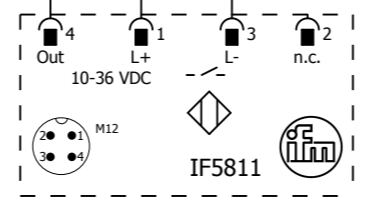
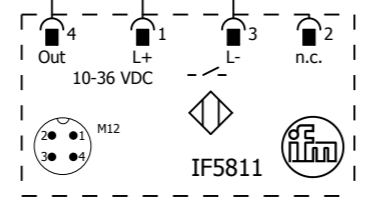

+20HHH21 CG101 -S01  
Sn=7mm

+20HHH21 CG102 -S01  
Sn=7mm

+20HHH21 GS101 -A01  
/74.2:D  
Zavážač 1  
Miestna ovládací skrinka

20HHH21 GS101 -S04  
Zasunúť

20HHH21 GS101 -S05  
Vysunúť

			Vypracoval Tomáš Sivok
			Kontroloval Began
			Schválil Began
Revízia	Dátum	Meno	Datum 6/2016

		Zákazník: Odvoz a likvidácia odpadu a.s.
		Zákazka: Riadenie rošta

--	--	--	--	--	--	--	--

**SIEMENS**  
SIEMENS s.r.o. ,Lamačská cesta 3/A  
841 04 Bratislava - SK

**Rozvádzač / Roštová dráha 1**  
**DI karta 1-4**

REV: 6/2016 PSV
Arch. číslo: P.02091.01

=	+20CBB01
List	73
Listov	12

-A13.2  
/73.1:A  
Rack X  
Slot Y

6ES7131-6BF00-0BA0 + BU15-P16+A10+2B DI 8x24 VDC ST

SIEMENS

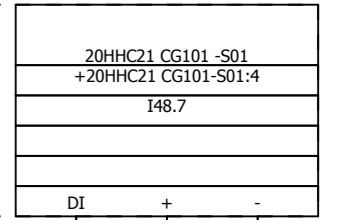
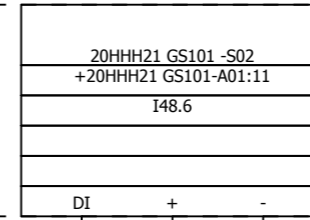
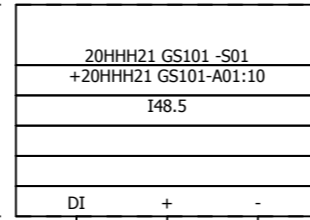
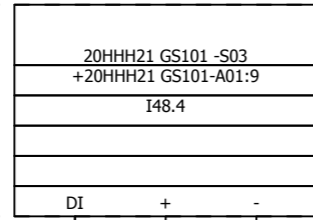

-20CBB01:5003  
/73.6:D  
802

GN

BN

WH

-20CBB01:5004  
801

GY

BU

RD

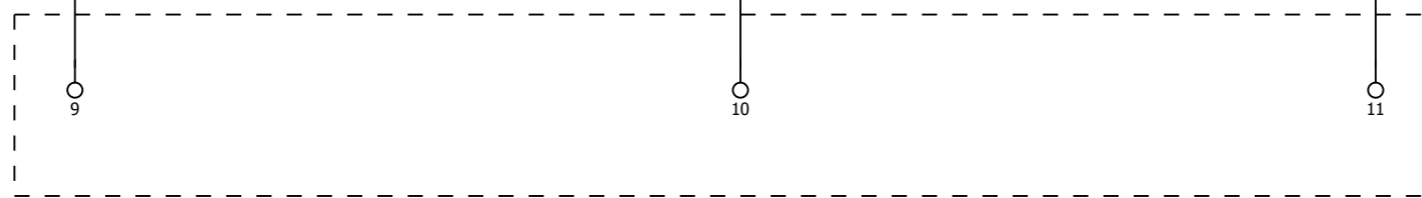

+20HHH21 GS101 -A01

/73.6:D

Zavážač 1

Miestna ovládacia skrinka

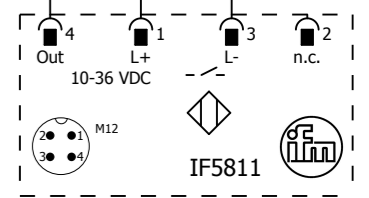

+20HHC21 CG101 -S01

Sn=7mm

20HHH21 GS101 -S03  
Nieje STOP

20HHH21 GS101 -S01  
Auto

20HHH21 GS101 -S02  
Pomaly

Revizia	Dátum	Meno	Datum

Zákazník:	Odvoz a likvidácia odpadu a.s.
Zákazka:	Riadenie rošta

**SIEMENS**  
SIEMENS s.r.o. ,Lamačská cesta 3/A  
841 04 Bratislava - SK

**Rozvádzač / Roštová dráha 1**  
  
**DI karta 5-8**

REV:	6/2016 PSV	
Arch. číslo:	P.02091.01	
		List 74
		Listov 12

© Copyright SIEMENS s.r.o. 2015

6ES7131-6BF00-0BA0 + BU15-P16+A10+2B DI 8x24 VDC ST

SIEMENS

-A13.3  
/76.1:A  
Rack X  
Slot Y

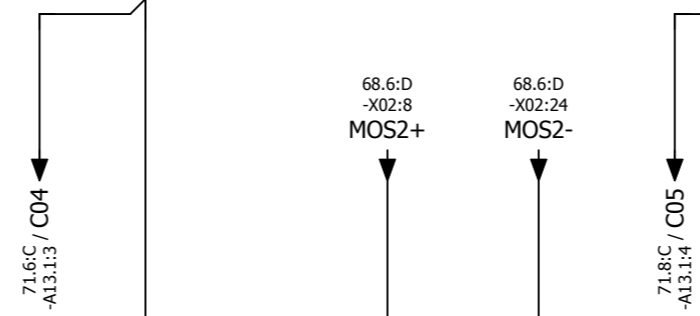
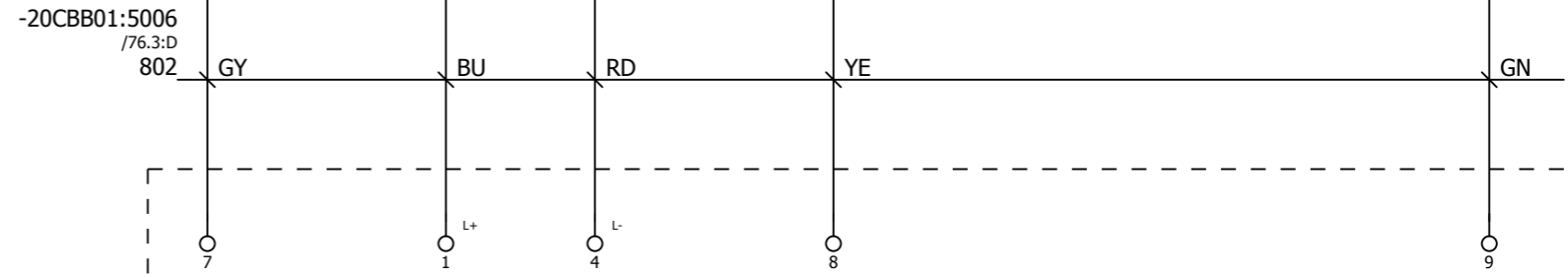
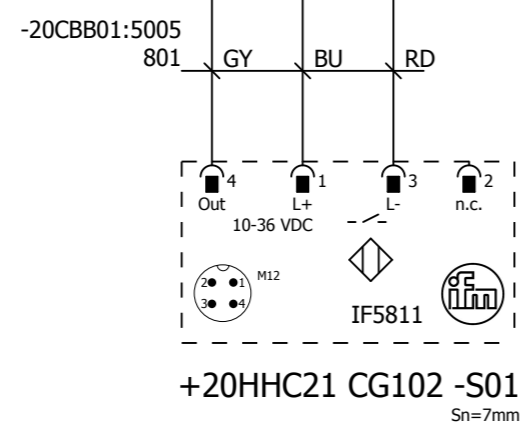
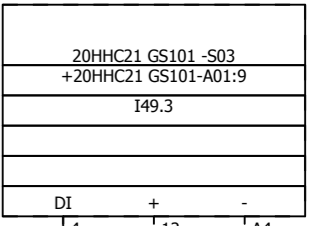
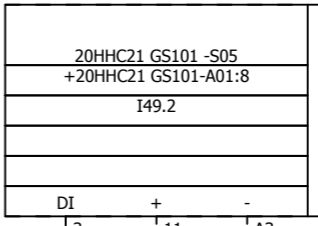
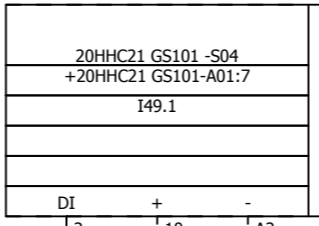
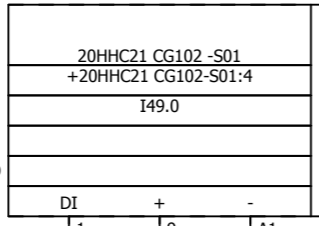
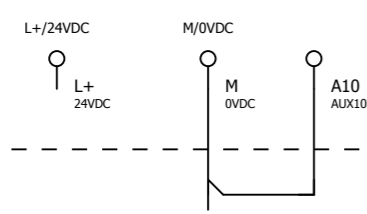

20HHC21 GS101 -S04  
Zasunúť

20HHC21 GS101 -S05  
Vysunúť

20HHC21 GS101 -S03  
Nieje STOP

+20HHC21 GS101 -A01  
/76.2:D  
Rošt 1  
Miestna ovládacia skrinka

© Copyright SIEMENS s.r.o. 2015

Revizia	Dátum	Meno	Datum
1	6/2016	Began	6/2016

Zákazník:	Odvoz a likvidácia odpadu a.s.
Zákazka:	Riadenie rošta

**SIEMENS**  
SIEMENS s.r.o. ,Lamačská cesta 3/A  
841 04 Bratislava - SK

**Rozvádzač / Roštová dráha 1**  
**DI karta 1-4**

REV: 6/2016 PSV	=
Arch. číslo: P.02091.01	+20CBB01
	List 75
	Listov 12

-A13.3  
/75.1:A  
Rack X  
Slot Y

6ES7131-6BF00-0BA0 + BU15-P16+A10+2B DI 8x24 VDC ST

SIEMENS

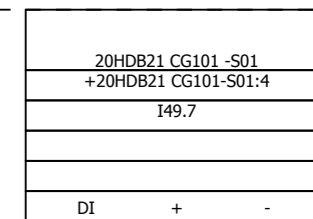
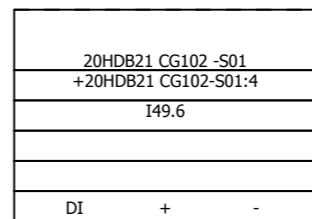
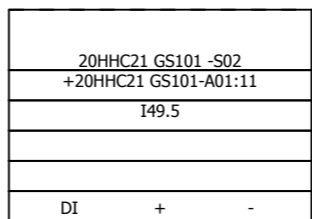
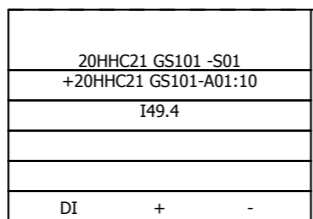

-20CBB01:5006  
/75.4:D  
802

BN

WH

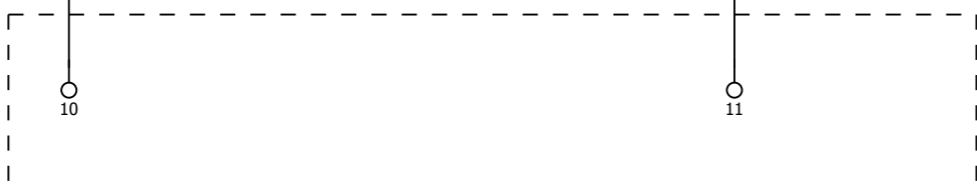

+20HHC21 GS101 -A01

/75.4:D

Rošt 1

Miestna ovládacia skrinka

20HHC21 GS101 -S01  
Auto

20HHC21 GS101 -S02  
Pomaly

-20CBB01:5007  
801

GY

BU

RD

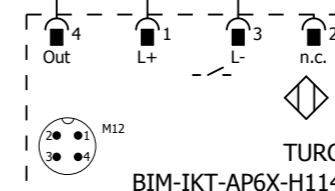

+20HDB21 CG102 -S01

-20CBB01:5008  
801

GY

BU

RD

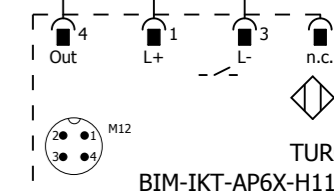

+20HDB21 CG101 -S01

© Copyright SIEMENS s.r.o. 2015

			Vypracoval Tomáš Sivok
			Kontroloval Began
			Schválil Began
Revizia	Dátum	Meno	Datum 6/2016

Zákazník: Odvoz a likvidácia odpadu a.s.
Zákazka: Riadenie rošta

**SIEMENS**  
SIEMENS s.r.o. ,Lamačská cesta 3/A  
841 04 Bratislava - SK

**Rozvádzač / Roštová dráha 1**  
**DI karta 5-8**

	=
REV: 6/2016 PSV	+20CBB01
Arch. číslo: P.02091.01	List 76
	Listov 12

-A13.4  
/78.1:A  
Rack X  
Slot Y

6ES7131-6BF00-0BA0 + BU15-P16+A10+2B DI 8x24 VDC ST

SIEMENS

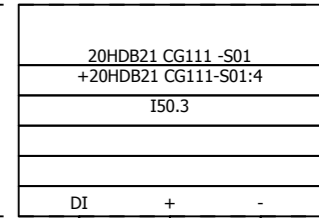
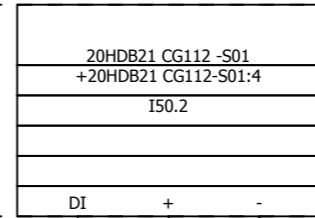
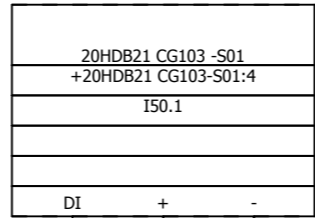
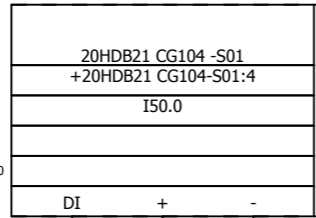
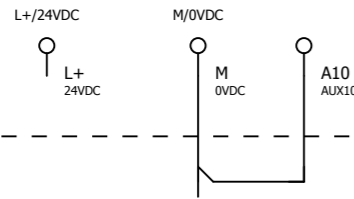

-20CBB01:5009  
801 GY BU RD

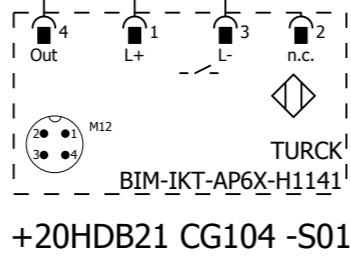

-20CBB01:5010  
801 GY BU RD

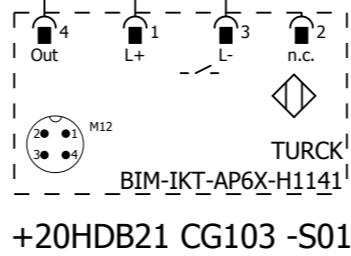

-20CBB01:5011  
801 GY BU RD

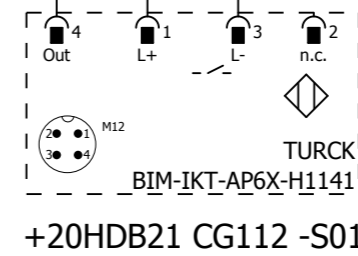

-20CBB01:5012  
801 GY BU RD

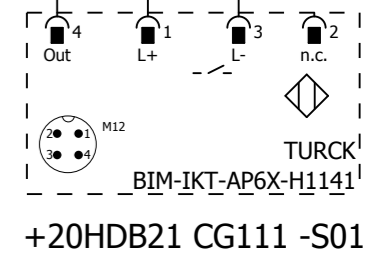

			Vypracoval Tomáš Sivok
			Kontroloval Began
			Schválil Began
Revizia	Dátum	Meno	Datum 6/2016

Zákazník: Odvoz a likvidácia odpadu a.s.
Zákazka: Riadenie rošta

**SIEMENS**  
SIEMENS s.r.o. ,Lamačská cesta 3/A  
841 04 Bratislava - SK

**Rozvádzač / Roštová dráha 1**  
**DI karta 1-4**

	=
REV: 6/2016 PSV	+20CBB01
Arch. číslo: P.02091.01	List 77
	Listov 12

© Copyright SIEMENS s.r.o. 2015

© Copyright SIEMENS s.r.o. 2015

-A13.4  
/77.1:A  
Rack X  
Slot Y

6ES7131-6BF00-0BA0 + BU15-P16+A10+2B DI 8x24 VDC ST

SIEMENS

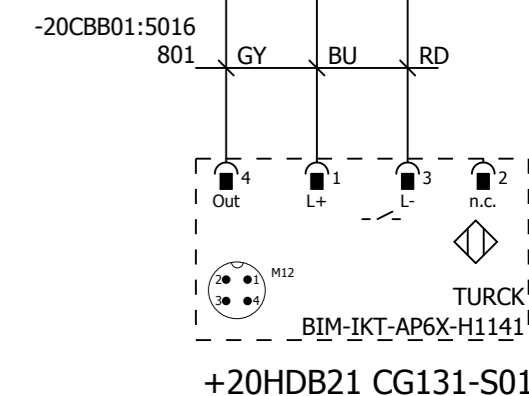
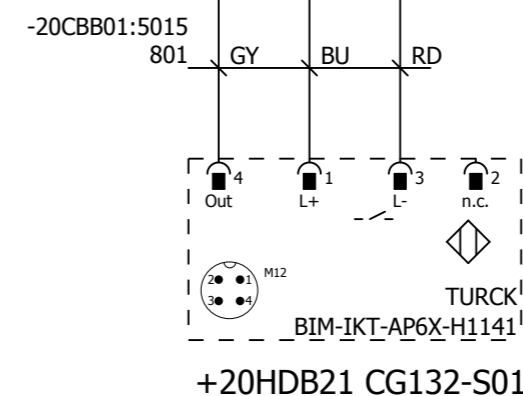
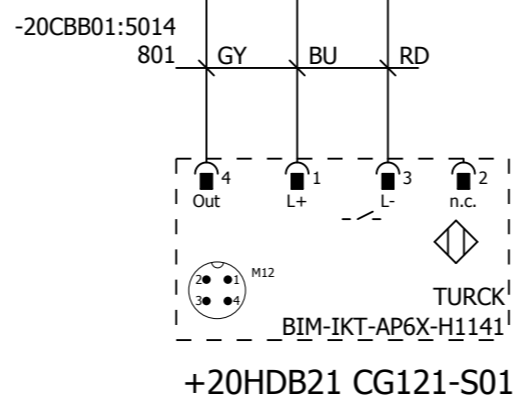
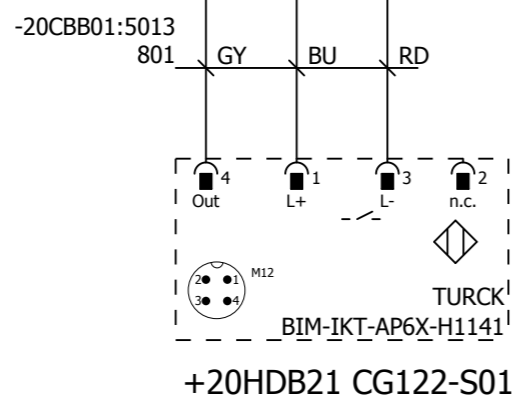
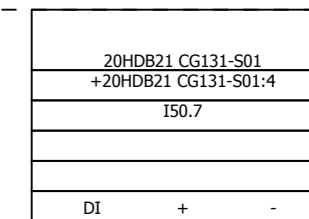
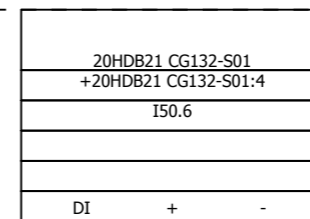
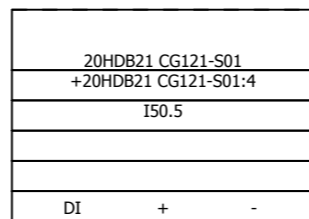
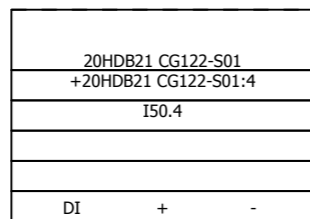

© Copyright SIEMENS s.r.o. 2015

Revizia	Dátum	Meno	Datum

Vypracoval	Tomáš Sivok	Zákazník:	Odvoz a likvidácia odpadu a.s.
Kontroloval	Began	Zákazka:	Riadenie rošta
Schválil	Began		
Datum	6/2016		

**SIEMENS**  
SIEMENS s.r.o. „Lamačská cesta 3/A  
841 04 Bratislava - SK

**Rozvádzač / Roštová dráha 1**  
**DI karta 5-8**

REV: 6/2016 PSV	=
Arch. číslo: P.02091.01	+20CBB01
	List 78
	Listov 12



-A13.5  
/80.1:A  
Rack X  
Slot Y

6ES7131-6BF00-0BA0 + BU15-P16+A10+2B DI 8x24 VDC ST

SIEMENS

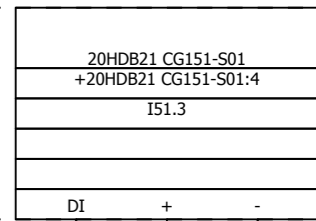
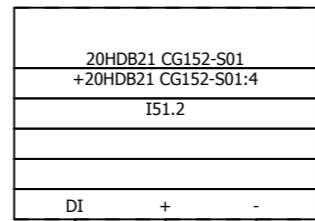
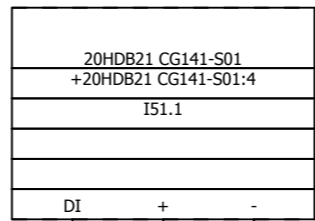
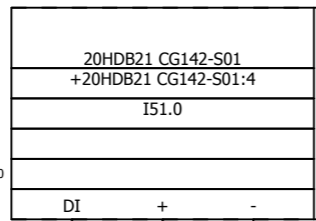
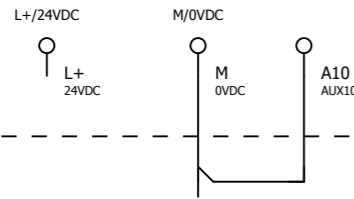

-20CBB01:5017  
801 GY BU RD

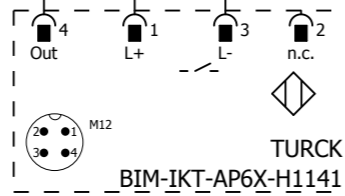

+20HDB21 CG142-S01

-20CBB01:5018  
801 GY BU RD

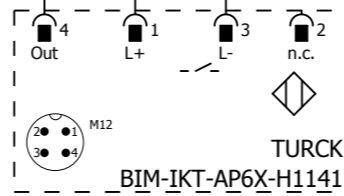

+20HDB21 CG141-S01

-20CBB01:5019  
801 GY BU RD

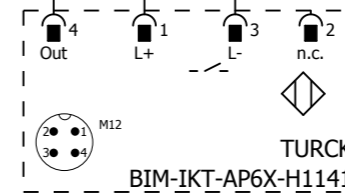

+20HDB21 CG152-S01

-20CBB01:5020  
801 GY BU RD

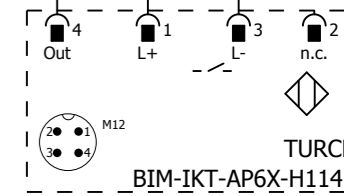

+20HDB21 CG151-S01

			Vypracoval Tomáš Sivok
			Kontroloval Began
			Schválil Began
Revizia	Dátum	Meno	Datum 6/2016

Zákazník: Odvoz a likvidácia odpadu a.s.
Zákazka: Riadenie rošta

**SIEMENS**  
SIEMENS s.r.o. „Lamačská cesta 3/A  
841 04 Bratislava - SK

**Rozvádzač / Roštová dráha 1**  
**DI karta 1-4**

	=
REV: 6/2016 PSV	+20CBB01
Arch. číslo: P.02091.01	List 79
	Listov 12

© Copyright SIEMENS s.r.o. 2015

© Copyright SIEMENS s.r.o. 2015

-A13.5  
/79.1:A  
Rack X  
Slot Y

6ES7131-6BF00-0BA0 + BU15-P16+A10+2B DI 8x24 VDC ST

SIEMENS

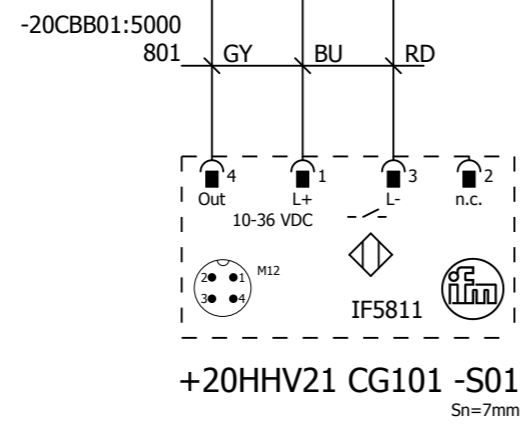
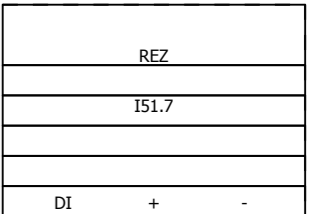
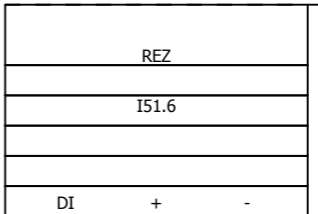
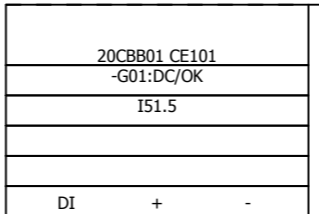
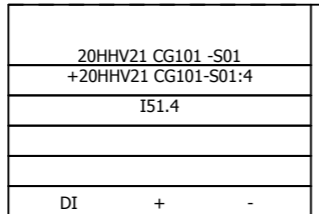

68.3:D / 24VOK  
-X02:33

+20CBB01 CE101  
rošt1 Napájanie OK

© Copyright SIEMENS s.r.o. 2015

			Vypracoval Tomáš Sivok
			Kontroloval Began
			Schválil Began
Revizia	Dátum	Meno	Datum 6/2016

Zákazník: Odvoz a likvidácia odpadu a.s.  
Zákazka: Riadenie rošta

**SIEMENS**  
SIEMENS s.r.o. , Lamačská cesta 3/A  
841 04 Bratislava - SK

**Rozvádzač / Roštová dráha 1**  
**DI karta 5-8**

	=
REV: 6/2016 PSV	+20CBB01
Arch. číslo: P.02091.01	List 80
	Listov 12

© Copyright SIEMENS s.r.o. 2015

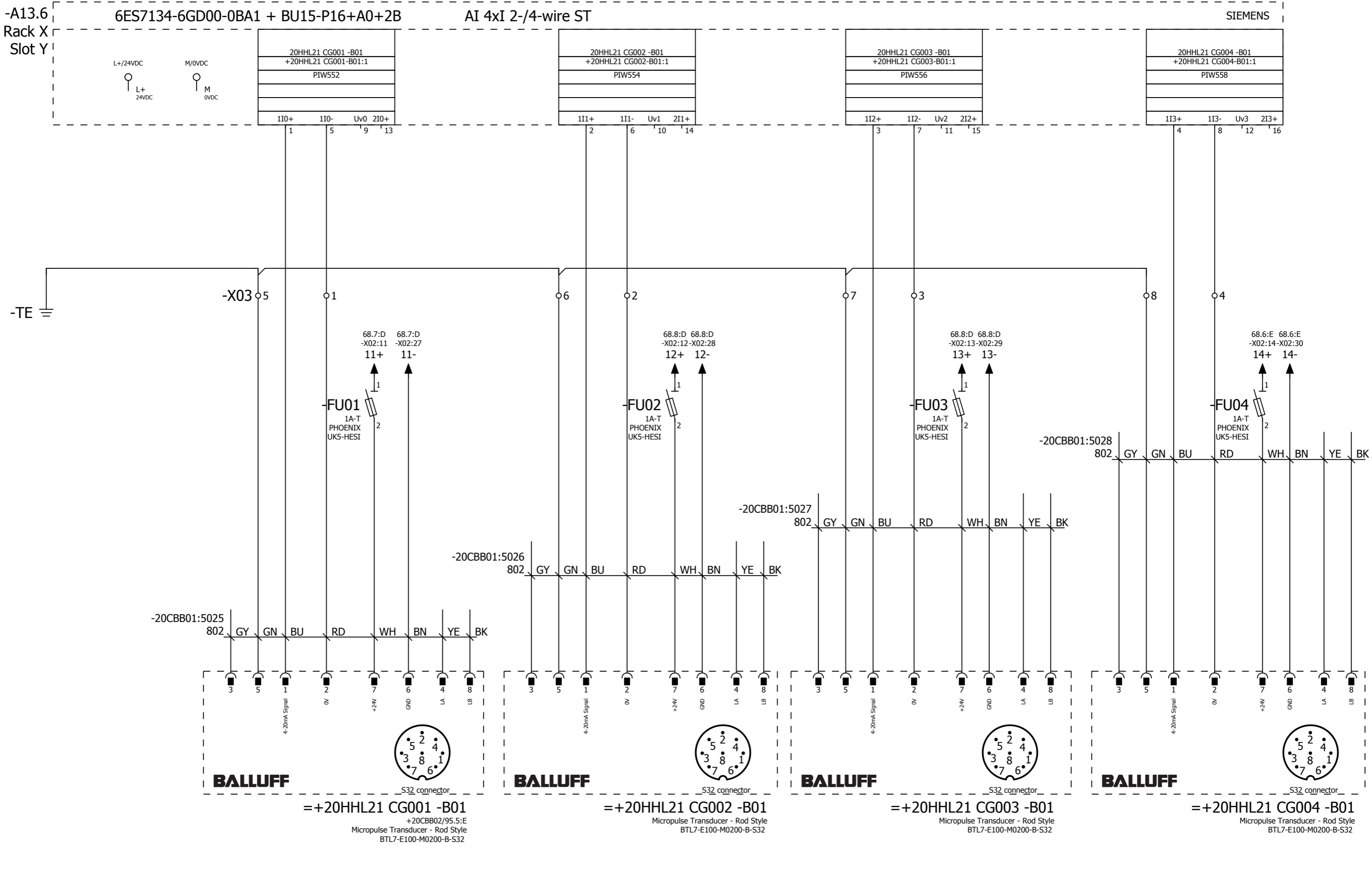

Revizia	Dátum	Meno	Datum
1			6/2016

Vypracoval Tomáš Sivok Kontroloval Began Schválil Began	Zákazník: Odvoz a likvidácia odpadu a.s. Zákazka: Riadenie rošta
---	---

**SIEMENS**  
SIEMENS s.r.o. „Lamačská cesta 3/A  
841 04 Bratislava - SK

**Rozvádzač / Roštová dráha 1**  
**AI karta**

REV: 6/2016 PSV	=
Arch. číslo: P.02091.01	+20CBB01
	List 81
	Listov 12

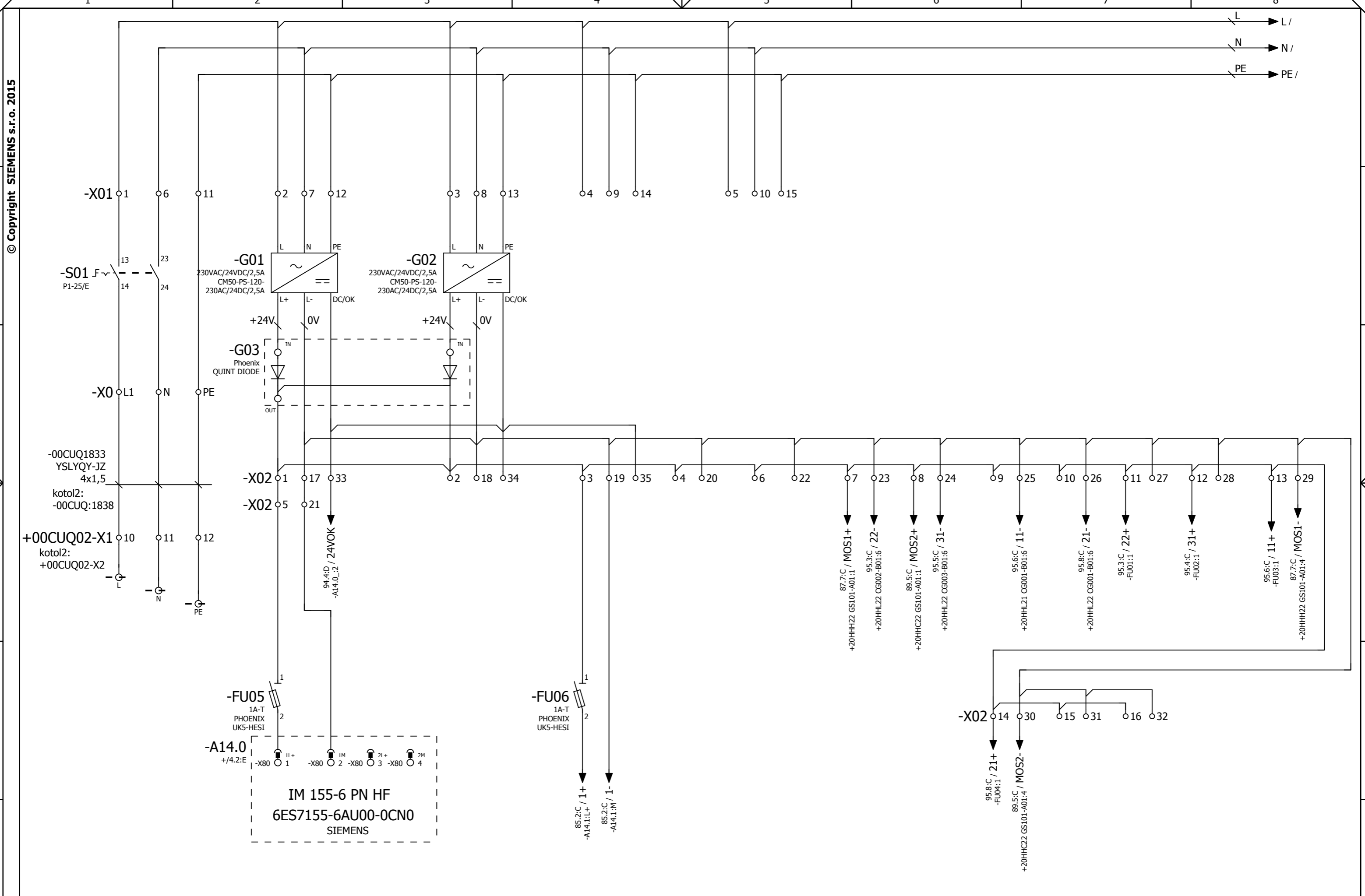

Revizia	Dátum	Meno	Datum
			6/2016

Vypracoval	Tomáš Sivok	Zákazník:	Odvoz a likvidácia odpadu a.s.
Kontroloval	Began	Zákazka:	Riadenie rošta
Schválil	Began		

**SIEMENS**  
SIEMENS s.r.o. „Lamačská cesta 3/A  
841 04 Bratislava - SK

**Rozvádzač / Roštová dráha 2**  
**Napájanie 230V AC/24V DC**

REV: 6/2016 PSV	=
Arch. číslo: P.02091.01	+20CBB02
	List 82
	Listov 12

-A14.1  
/86.1:A  
Rack X  
Slot Y

6ES7132-6BF00-0BA0 + BU15-P16+A0+2D DQ 8x24 VDC/0,5A ST

SIEMENS

L+/24VDC  
L+  
24VDC

M/0VDC  
M  
0VDC

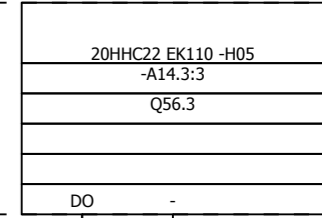
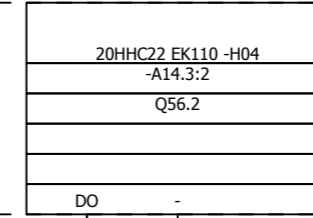
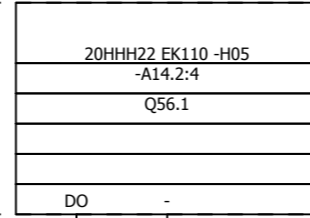
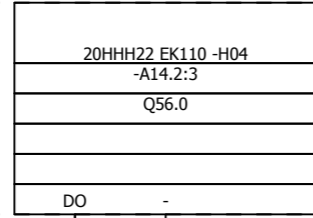

1+  
82.4:E  
-FU06:2

1-  
82.4:E  
-X02:19

H04  
87.6:C  
-A14.2:3

H05  
87.7:C  
-A14.2:4

C04  
89.4:C  
-A14.3:2

C05  
89.6:C  
-A14.3:3

© Copyright SIEMENS s.r.o. 2015

Revizia	Dátum	Meno	Datum

Vypracoval	Tomáš Sivok	Zákazník:	Odvoz a likvidácia odpadu a.s.
Kontroloval	Began	Zákazka:	<b>Riadenie rošta</b>
Schválil	Began		
Datum	6/2016		

**SIEMENS**  
SIEMENS s.r.o. „Lamačská cesta 3/A  
841 04 Bratislava - SK

**Rozvádzač / Roštová dráha 2**  
**4DO karta**

REV: 6/2016 PSV	=
Arch. číslo: P.02091.01	+20CBB02
	List 85
	Listov 12

-A14.1  
/85.1:A  
Rack X  
Slot Y

6ES7132-6BF00-0BA0 + BU15-P16+A0+2D DQ 8x24 VDC/0,5A ST

SIEMENS

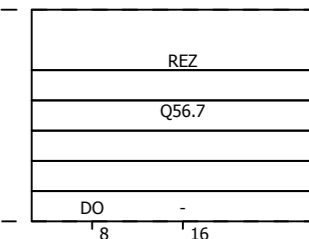
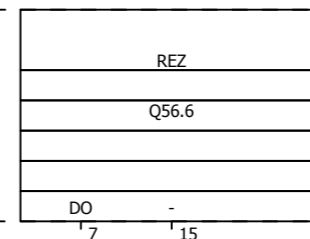
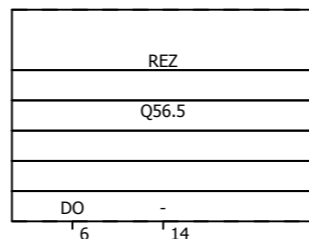
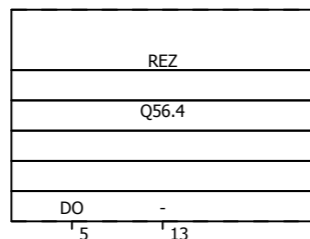

© Copyright SIEMENS s.r.o. 2015

			Vypracoval Tomáš Sivok
			Kontroloval Began
			Schválil Began
Revizia	Dátum	Meno	Datum 6/2016

Zákazník:	Odvoz a likvidácia odpadu a.s.
Zákazka:	<b>Riadenie rošta</b>

**SIEMENS**  
SIEMENS s.r.o. „Lamačská cesta 3/A  
841 04 Bratislava - SK

**Rozvádzač / Roštová dráha 2**  
**4DO karta**

	=
REV: 6/2016 PSV	+20CBB02
Arch. číslo: P.02091.01	List 86
	Listov 12

6ES7131-6BF00-0BA0 + BU15-P16+A10+2B DI 8x24 VDC ST

SIEMENS

-A14.2  
/88.1:A  
Rack X  
Slot Y

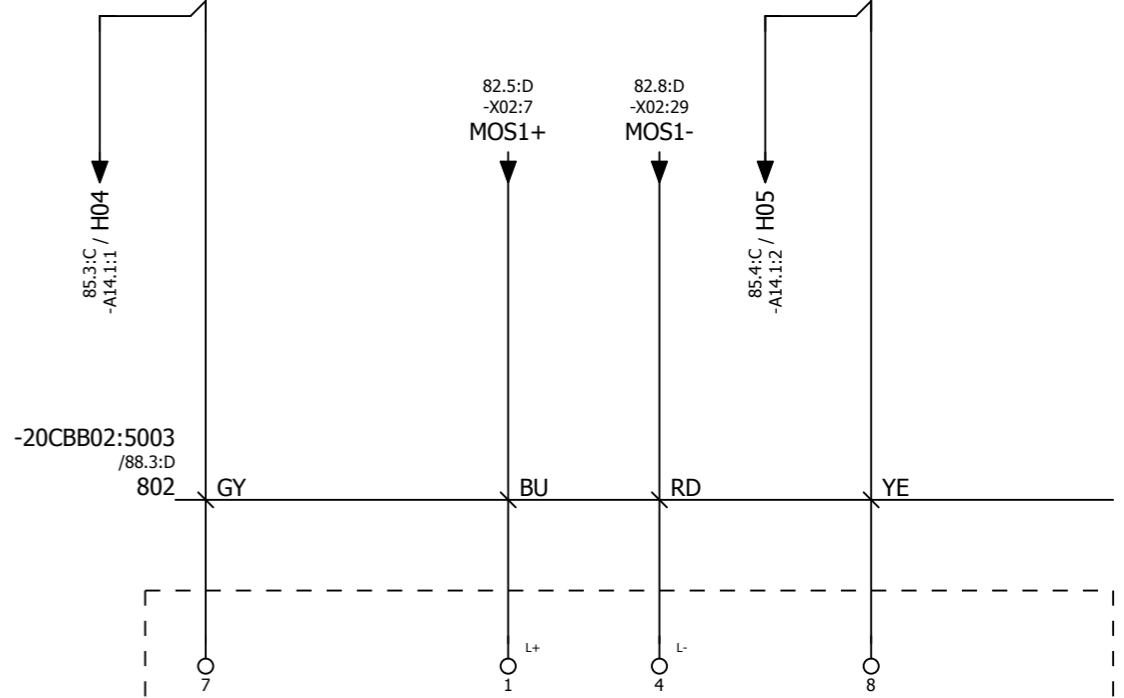
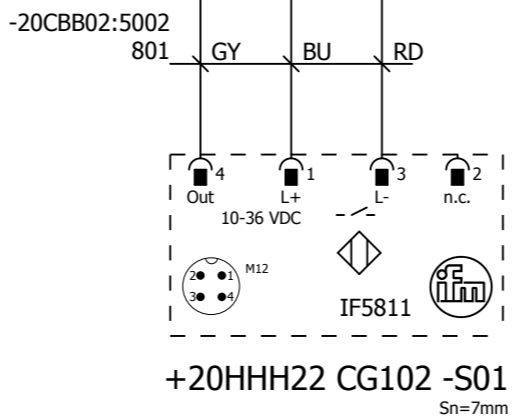
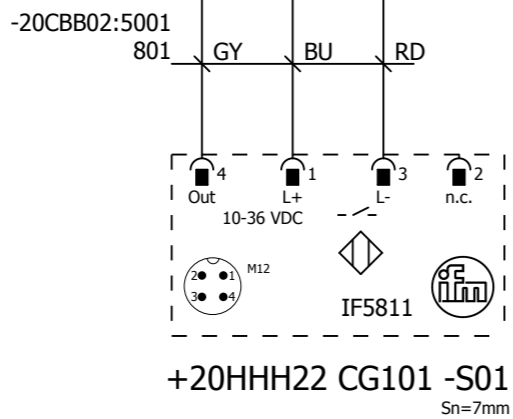
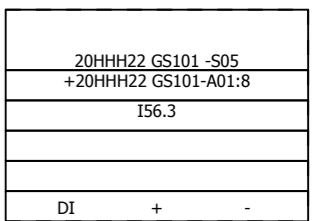
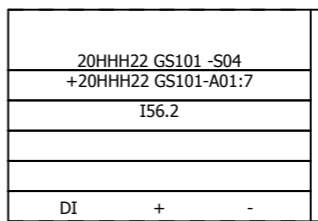
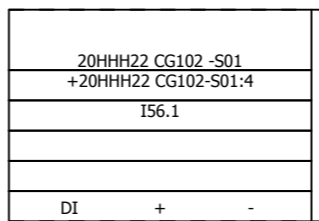
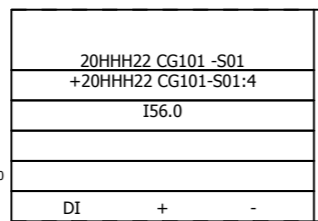
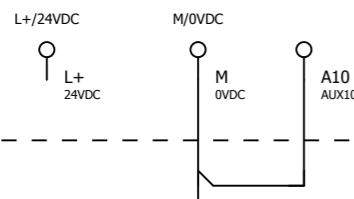

20HHH22 GS101 -S04  
Zasunúť

20HHH22 GS101 -S05  
Vysunúť

			Vypracoval Tomáš Sivok
			Kontroloval Began
			Schválil Began
Revizia	Dátum	Meno	Datum 6/2016

Zákazník: Odvoz a likvidácia odpadu a.s.  
Zákazka: Riadenie rošta

**SIEMENS**  
SIEMENS s.r.o. „Lamačská cesta 3/A  
841 04 Bratislava - SK

**Rozvádzač / Roštová dráha 2**  
**DI karta 1-4**

	=
REV: 6/2016 PSV	+20CBB02
Arch. číslo: P.02091.01	List 87
	Listov 12

-A14.2  
/87.1:A  
Rack X  
Slot Y

6ES7131-6BF00-0BA0 + BU15-P16+A10+2B DI 8x24 VDC ST

SIEMENS



-20CBB02:5003  
/87.6:D  
802

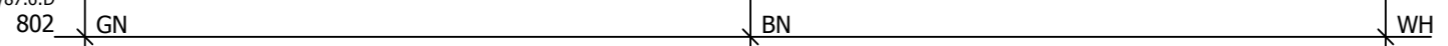

-20CBB02:5004  
801

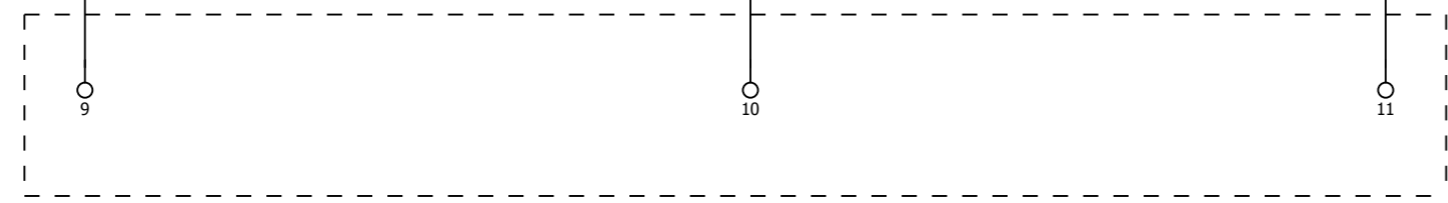
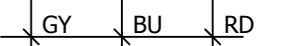

+20HHH22 GS101 -A01  
/87.6:D  
Zavážač 2  
Miestna ovládacia skrinka

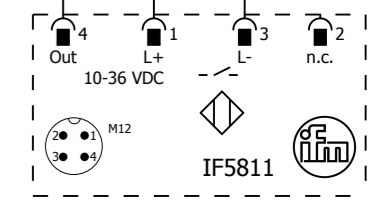

+20HHC22 CG101 -S01  
Sn=7mm

20HHH22 GS101 -S03  
Nieje STOP

20HHH22 GS101 -S01  
Auto

20HHH22 GS101 -S02  
Pomaly

A B C D E F

Revizia	Dátum	Meno	Datum
1	2	3	4

Vypracoval Tomáš Sivok Kontroloval Began Schválil Began Datum 6/2016	Zákazník: Odvoz a likvidácia odpadu a.s. Zákazka: <b>Riadenie rošta</b>
---	--

**SIEMENS**  
SIEMENS s.r.o. „Lamačská cesta 3/A  
841 04 Bratislava - SK

**Rozvádzač / Roštová dráha 2**  
**DI karta 5-8**

REV: 6/2016 PSV	=
Arch. číslo: P.02091.01	+20CBB02

List	88
Listov	12



-A14.3  
/90.1:A  
Rack X  
Slot Y

6ES7131-6BF00-0BA0 + BU15-P16+A10+2B DI 8x24 VDC ST

SIEMENS

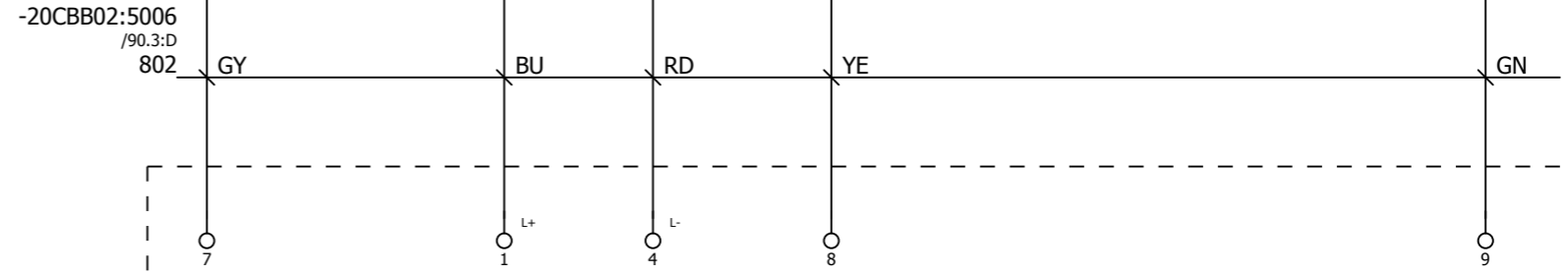
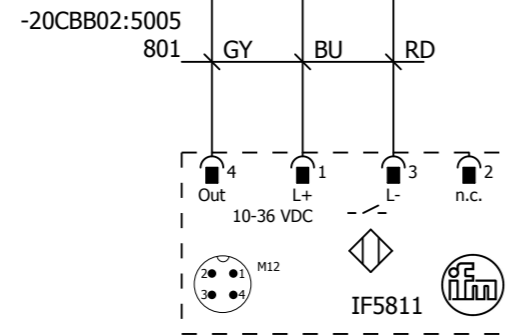
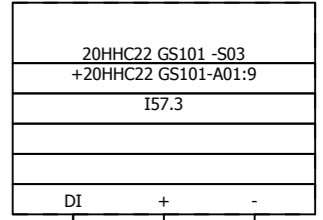
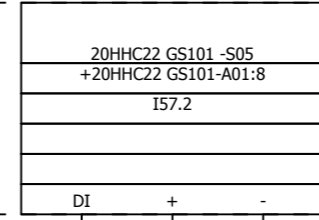
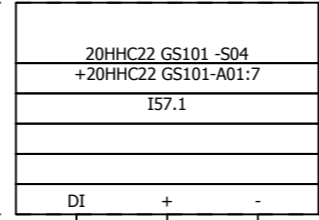
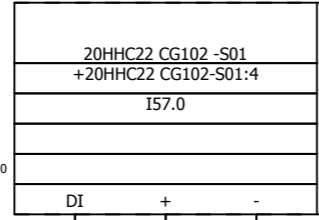
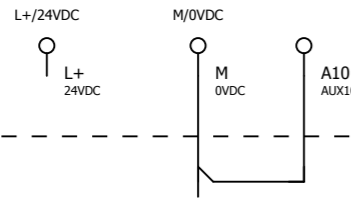

+20HHC22 CG102 -S01  
Sn=7mm

+20HHC22 GS101 -A01  
/90.2:D  
Rošt 2  
Miestna ovládacia skrinka

20HHC22 GS101 -S04  
Zasunúť

20HHC22 GS101 -S05  
Vysunúť

20HHC22 GS101 -S03  
Nieje STOP

© Copyright SIEMENS s.r.o. 2015

			Vypracoval: Tomáš Sivok
			Kontroloval: Began
			Schválil: Began
Revizia	Dátum	Meno	Datum: 6/2016

Zákazník: Odvoz a likvidácia odpadu a.s.
Zákazka: Riadenie rošta

**SIEMENS**  
SIEMENS s.r.o. , Lamačská cesta 3/A  
841 04 Bratislava - SK

**Rozvádzač / Roštová dráha 2**  
**DI karta 1-4**

=	+20CBB02
REV: 6/2016 PSV	List 89
Arch. číslo: P.02091.01	Listov 12

-A14.3  
/89.1:A  
Rack X  
Slot Y

6ES7131-6BF00-0BA0 + BU15-P16+A10+2B DI 8x24 VDC ST

SIEMENS

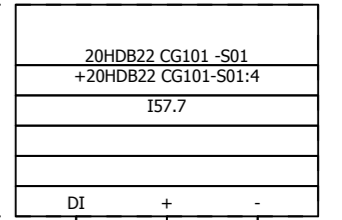
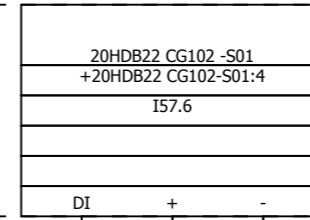
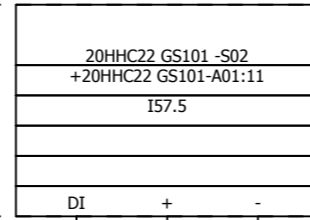
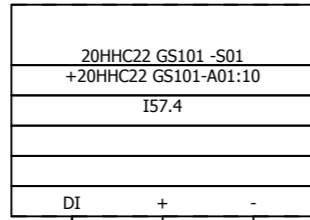

-20CBB02:5006  
/89.4:D  
802

BN

WH

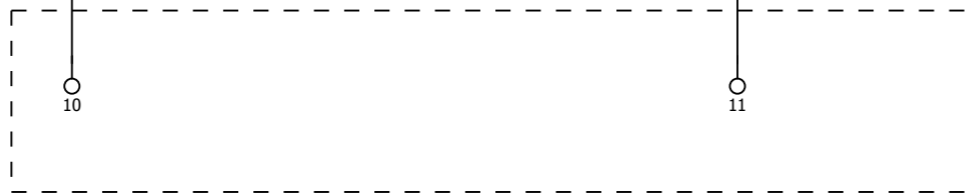

+20HHC22 GS101 -A01

/89.4:D  
Rošt 2  
Miestna ovládacia skrinka

20HHC22 GS101 -S01  
Auto

20HHC22 GS101 -S02  
Pomaly

-20CBB02:5007  
801

GY

BU

RD

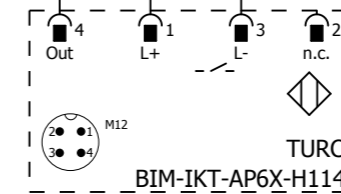

+20HDB22 CG102 -S01

-20CBB02:5008  
801

GY

BU

RD

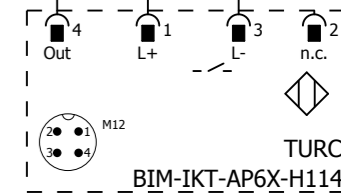

+20HDB22 CG101 -S01

© Copyright SIEMENS s.r.o. 2015

			Vypracoval Tomáš Sivok
			Kontroloval Began
			Schválil Began
Revizia	Dátum	Meno	Datum 6/2016

Zákazník: Odvoz a likvidácia odpadu a.s.
Zákazka: Riadenie rošta

**SIEMENS**  
SIEMENS s.r.o. ,Lamačská cesta 3/A  
841 04 Bratislava - SK

**Rozvádzač / Roštová dráha 2**  
**DI karta 5-8**

	=
REV: 6/2016 PSV	+20CBB02
Arch. číslo: P.02091.01	List 90
	Listov 12

-A14.4  
/92.1:A  
Rack X  
Slot Y

6ES7131-6BF00-0BA0 + BU15-P16+A10+2B DI 8x24 VDC ST

SIEMENS

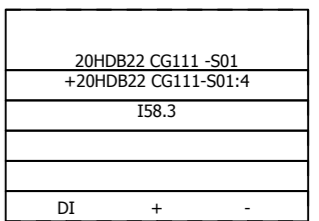
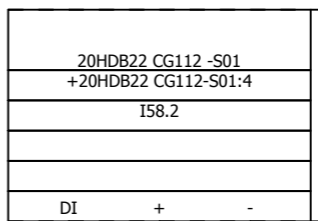
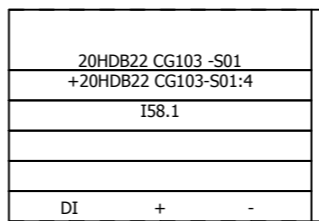
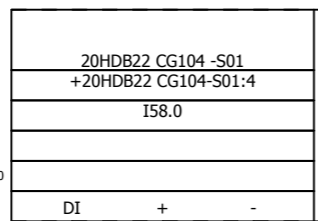
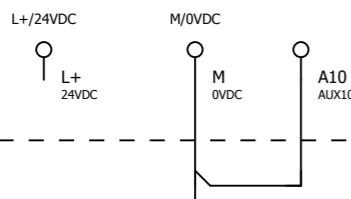

-20CBB02:5009  
801 GY BU RD

-20CBB02:5010  
801 GY BU RD

-20CBB02:5011  
801 GY BU RD

-20CBB02:5012  
801 GY BU RD

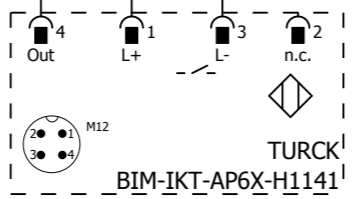

+20HDB22 CG104 -S01

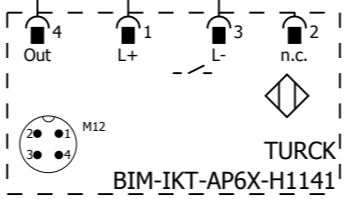

+20HDB22 CG103 -S01

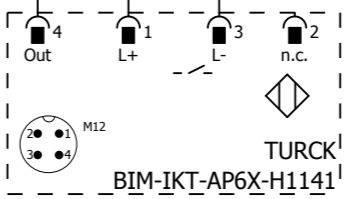

+20HDB22 CG112 -S01

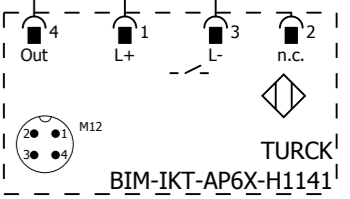

+20HDB22 CG111 -S01

			Vypracoval Tomáš Sivok Kontroloval Began Schválil Began Datum 6/2016	Zákazník: Odvoz a likvidácia odpadu a.s. Zákazka: Riadenie rošta	<b>SIEMENS</b> SIEMENS s.r.o. ,Lamačská cesta 3/A 841 04 Bratislava - SK	<b>Rozvádzač / Roštová dráha 2</b>  <b>DI karta 1-4</b>	REV: 6/2016 PSV Arch. číslo: P.02091.01	= +20CBB02 List 91 Listov 12
1	2	3	4	5	6	7	8	

© Copyright SIEMENS s.r.o. 2015

-A14.4  
/91.1:A  
Rack X  
Slot Y

### 6ES7131-6BF00-0BA0 + BU15-P16+A10+2B DI 8x24 VDC ST

SIEMENS

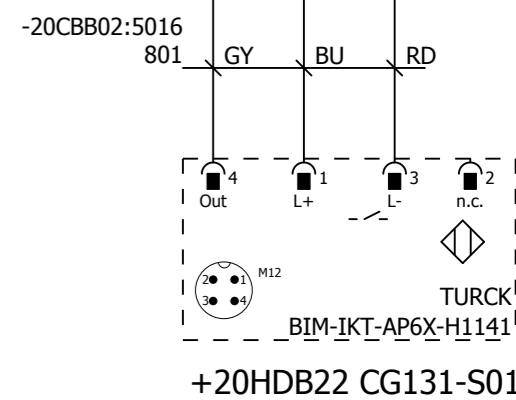
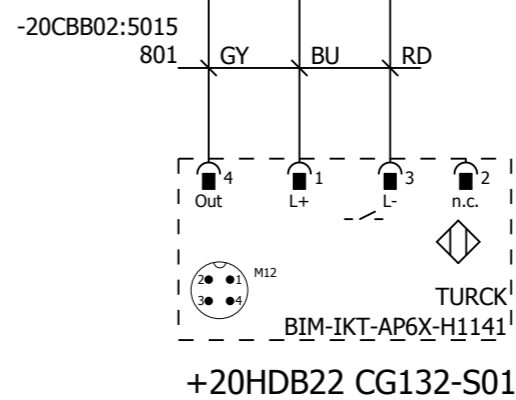
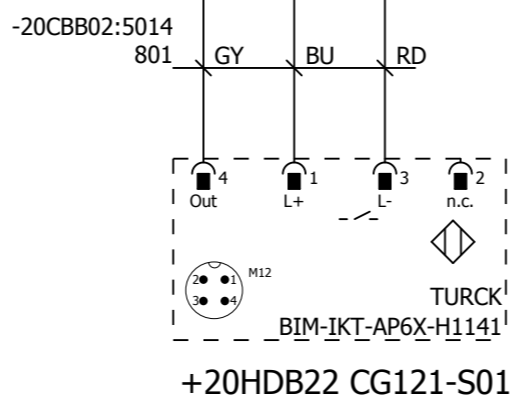
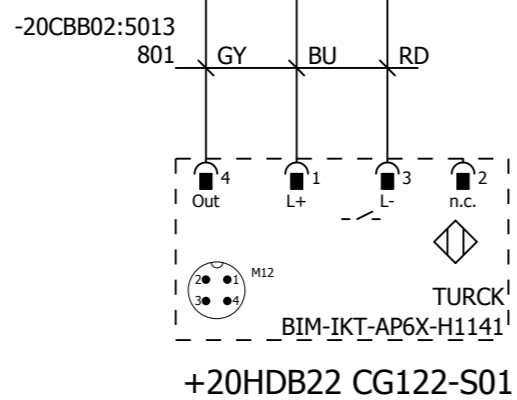
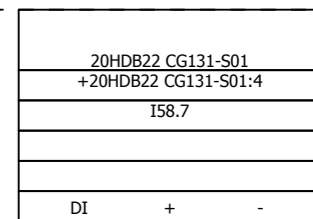
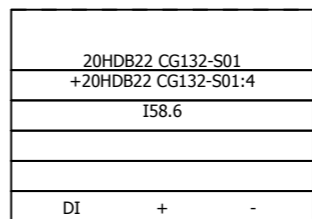
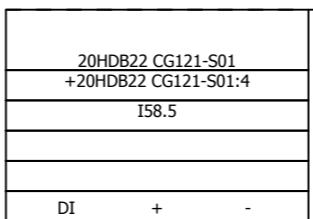
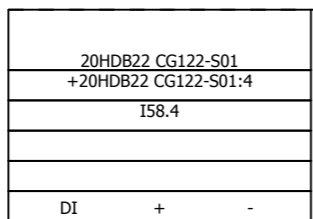

© Copyright SIEMENS s.r.o. 2015

			Vypracoval Tomáš Sivok
			Kontroloval Began
			Schválil Began
Revizia	Dátum	Meno	Datum 6/2016
1		2	

Zákazník: Odvoz a likvidácia odpadu a.s.
Zákazka: Riadenie rošta

**SIEMENS**  
SIEMENS s.r.o. , Lamačská cesta 3/A  
841 04 Bratislava - SK

**Rozvádzač / Roštová dráha 2**  
**DI karta 5-8**

	=
REV: 6/2016 PSV	+20CBB02
Arch. číslo: P.02091.01	List 92
	Listov 12

-A14.5  
/94.1:A  
Rack X  
Slot Y

6ES7131-6BF00-0BA0 + BU15-P16+A10+2B DI 8x24 VDC ST

SIEMENS

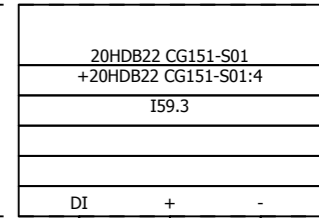
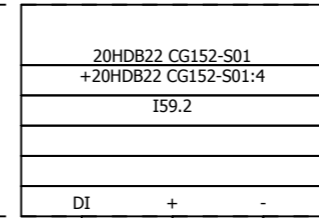
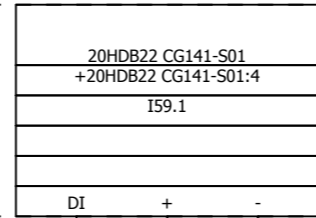
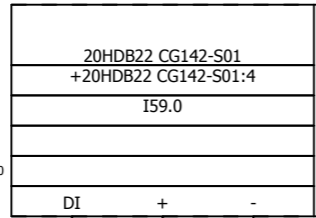
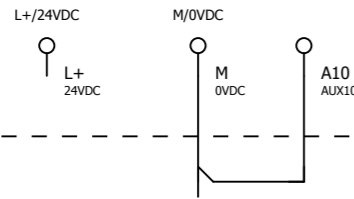

-20CBB02:5017  
801 GY BU RD

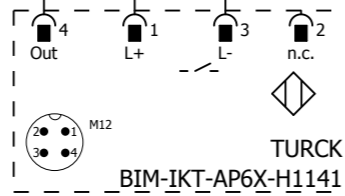

+20HDB22 CG142-S01

-20CBB02:5018  
801 GY BU RD

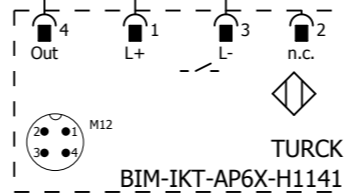

+20HDB22 CG141-S01

-20CBB02:5019  
801 GY BU RD

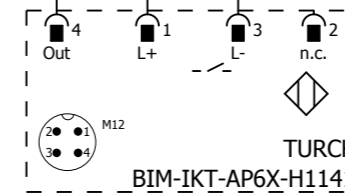

+20HDB22 CG152-S01

-20CBB02:5020  
801 GY BU RD

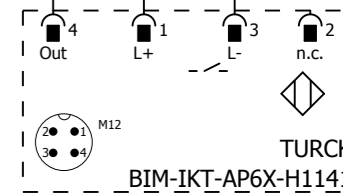

+20HDB22 CG151-S01

© Copyright SIEMENS s.r.o. 2015

Revizia	Dátum	Meno	Datum	6/2016
		Schválil	Began	
		Kontroloval	Began	
		Vypracoval	Tomáš Sivok	

Zákazník:	Odvoz a likvidácia odpadu a.s.
Zákazka:	Riadenie rošta

**SIEMENS**  
SIEMENS s.r.o. ,Lamačská cesta 3/A  
841 04 Bratislava - SK

**Rozvádzač / Roštová dráha 2**  
**DI karta 1-4**

REV: 6/2016 PSV	=
Arch. číslo: P.02091.01	+20CBB02
	List 93
	Listov 12

-A14.5  
/93.1:A  
Rack X  
Slot Y

6ES7131-6BF00-0BA0 + BU15-P16+A10+2B DI 8x24 VDC ST

SIEMENS

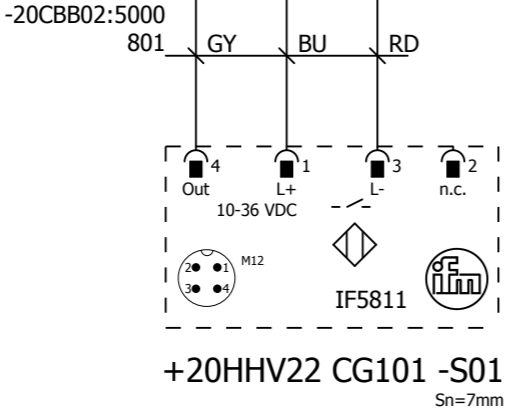
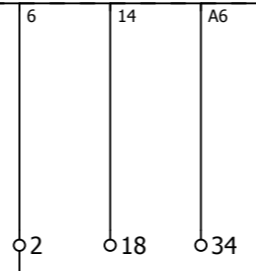
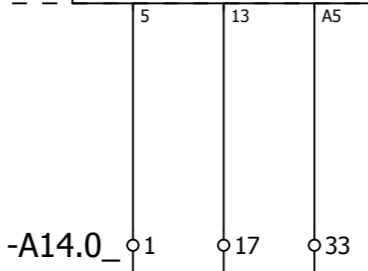
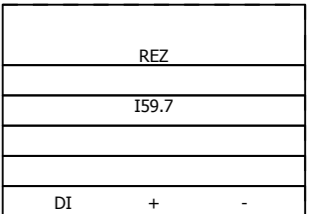
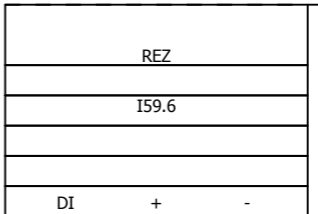
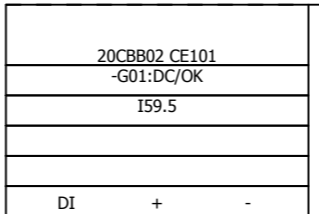
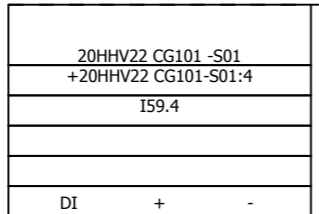

+20CBB02 CE101  
rošt. dráha 2 Napájanie OK

© Copyright SIEMENS s.r.o. 2015

			Vypracoval Tomáš Sivok
			Kontroloval Began
			Schválil Began
Revizia	Dátum	Meno	Datum 6/2016

Zákazník:	Odvoz a likvidácia odpadu a.s.
Zákazka:	Riadenie rošta

**SIEMENS**  
SIEMENS s.r.o. ,Lamačská cesta 3/A  
841 04 Bratislava - SK

**Rozvádzač / Roštová dráha 2**  
**DI karta 5-8**

	=
REV: 6/2016 PSV	+20CBB02
Arch. číslo: P.02091.01	List 94
	Listov 12

© Copyright SIEMENS s.r.o. 2015

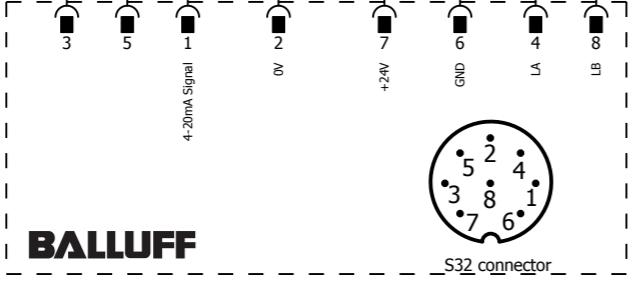
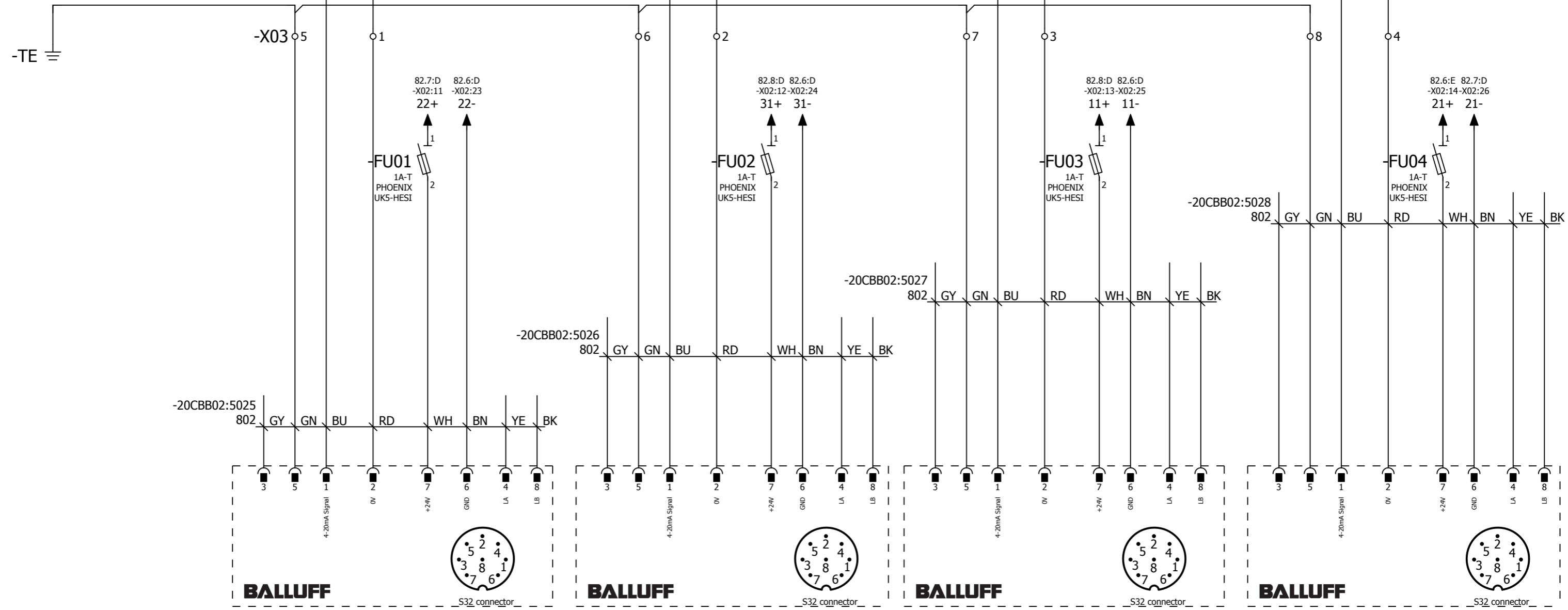
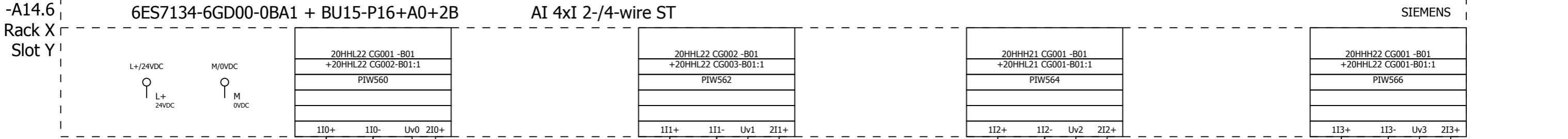

**=+20HHL22 CG002 -B01**  
Micropulse Transducer - Rod Style  
BTL7-E100-M0200-B-S32

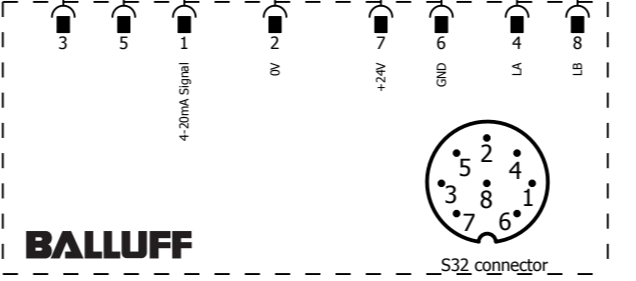

**=+20HHL22 CG003 -B01**  
Micropulse Transducer - Rod Style  
BTL7-E100-M0200-B-S32

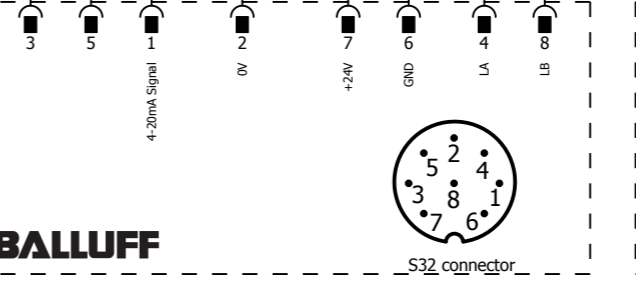

**=+20HHL21 CG001 -B01**  
+20CBB01/81.2:E  
Micropulse Transducer - Rod Style  
BTL7-E100-M1200-B-S32

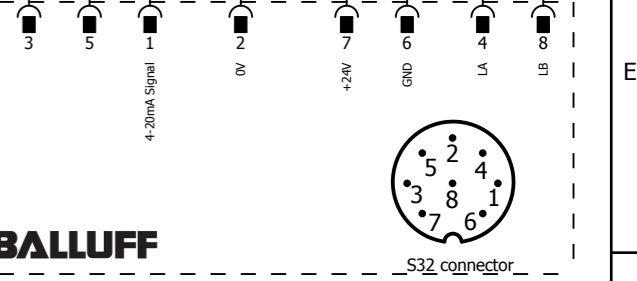

**=+20HHL22 CG001 -B01**  
Micropulse Transducer - Rod Style  
BTL7-E100-M1200-B-S32

Revizia	Dátum	Meno	Vypracoval Tomáš Sivok
			Kontroloval Began
			Schválil Began
			Datum 6/2016

Zákazník:	Odvoz a likvidácia odpadu a.s.
Zákazka:	Riadenie rošta

**SIEMENS**  
SIEMENS s.r.o. „Lamačská cesta 3/A  
841 04 Bratislava - SK

**Rozvádzač / Roštová dráha 2**  
**AI karta**

REV: 6/2016 PSV	=
Arch. číslo: P.02091.01	+20CBB02
	List 95
	Listov 12

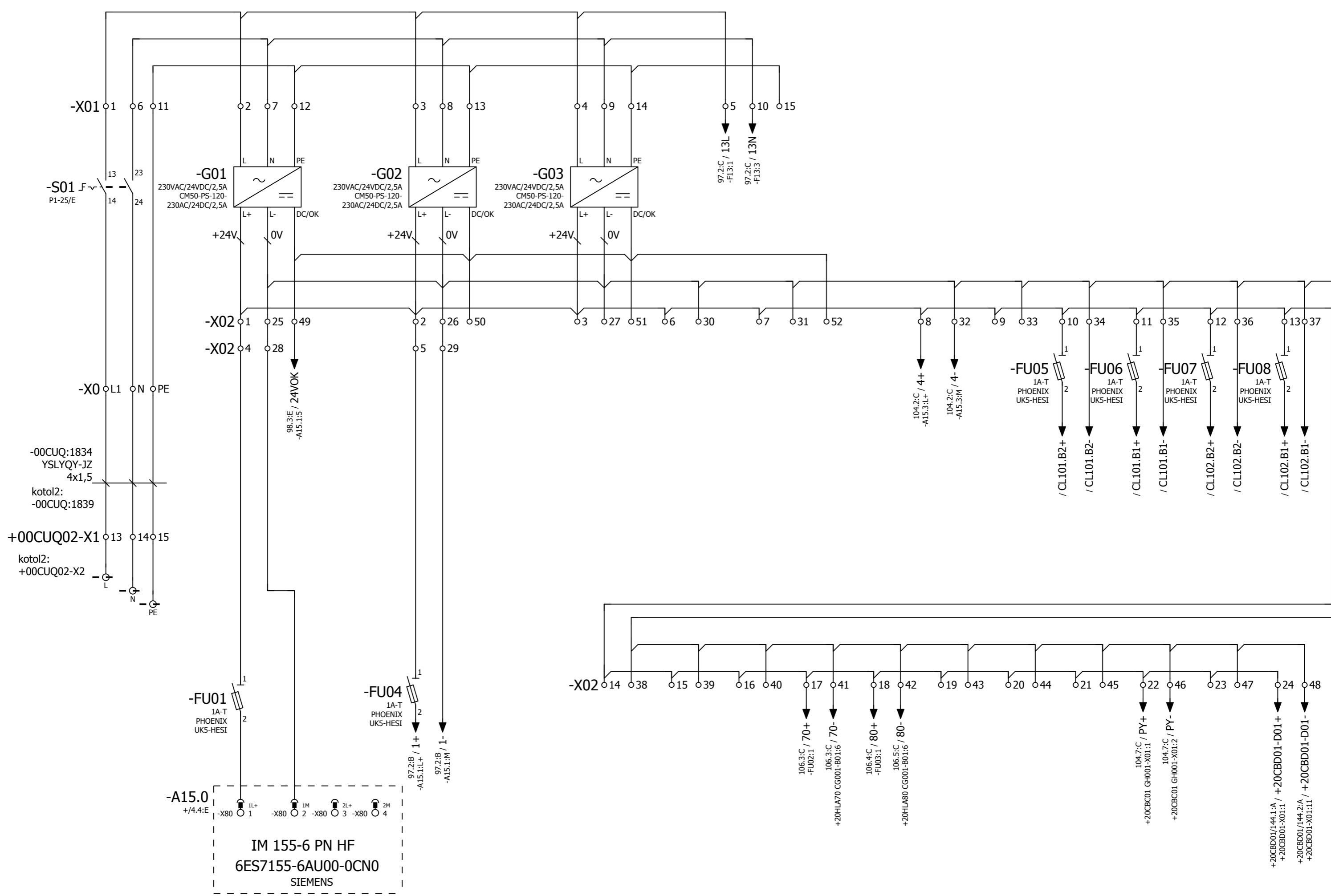

Revizia	Dátum	Meno	Datum
			6/2016

Vypracoval: Tomáš Sivok Kontroloval: Began Schválil: Began	Zákazník: Odvoz a likvidácia odpadu a.s. Zákazka: Riadenie rošta
--	---

**SIEMENS**  
 SIEMENS s.r.o. „Lamačská cesta 3/A  
 841 04 Bratislava - SK

**Rozvádzač / Zklz odpadu a sek. Vzduchu**  
**Napájanie 230V AC/24V DC**

REV: 6/2016 PSV	
Arch. číslo: P.02091.01	

=	+20CBC01
List	96
Listov	5



-A15.1  
/98.1:A  
Rack X  
Slot Y

6ES7131-6BF00-0BA0 + BU15-P16+A10+2D DI 8x24 VDC ST

SIEMENS

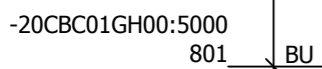
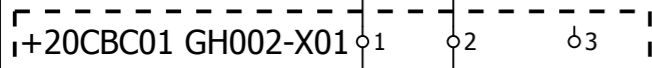
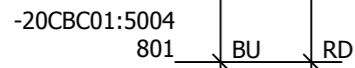
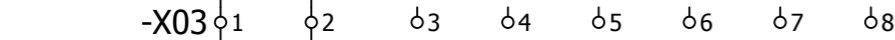
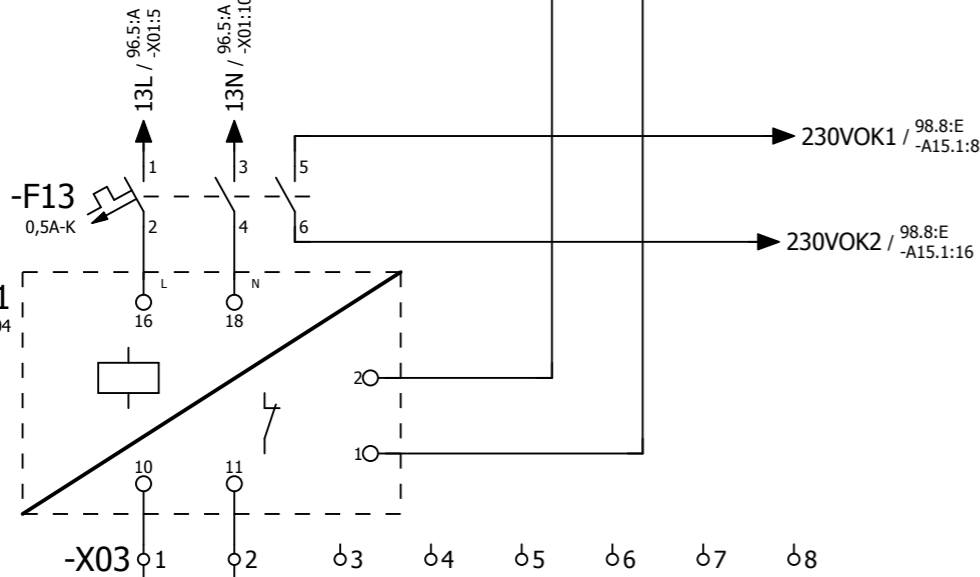
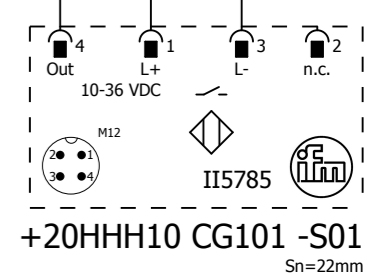
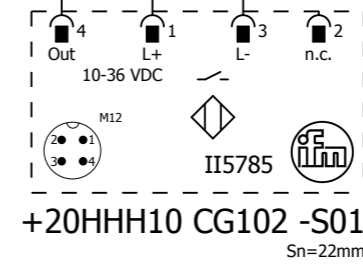
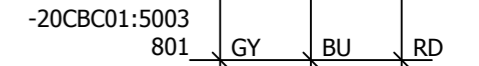
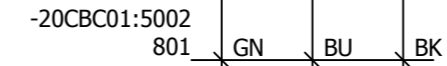
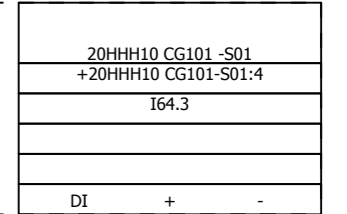
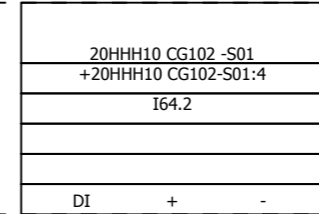
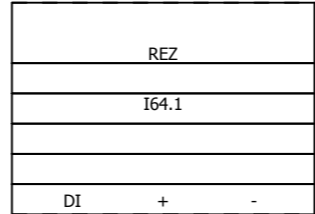
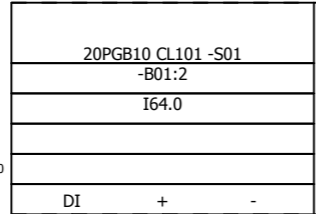
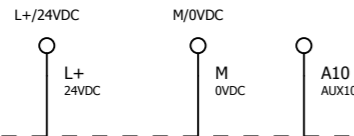

+20PGB10 CL101 -S01

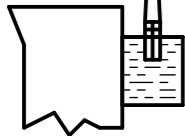

© Copyright SIEMENS s.r.o. 2015

Revizia	Dátum	Meno	Datum
			6/2016

Vypracoval Tomáš Sivok Kontroloval Began Schválil Began	Zákazník: Odvoz a likvidácia odpadu a.s. Zákazka: Riadenie rošta
---	---

**SIEMENS**  
SIEMENS s.r.o. ,Lamačská cesta 3/A  
841 04 Bratislava - SK

**Rozvádzač / Zklz odpadu a sek. Vzduchu**  
**DI karta 1-4**

REV: 6/2016 PSV	=
Arch. číslo: P.02091.01	+20CBC01
	List 97
	Listov 5

-A15.1  
/97.1:A  
Rack X  
Slot Y

6ES7131-6BF00-0BA0 + BU15-P16+A10+2D DI 8x24 VDC ST

SIEMENS

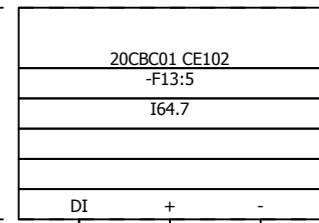
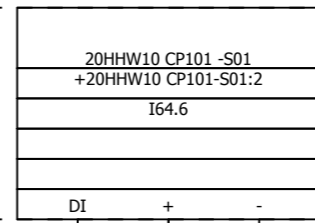
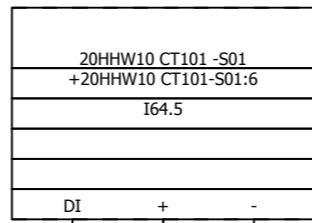
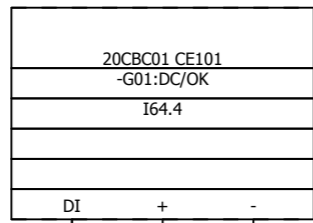

-20CBC01:6005  
/104.6:D  
802

BN GN

BK WH



+20CBC01 GH001:6000  
802

BN GN

+20CBC01 GH001:5000  
802

RD BU

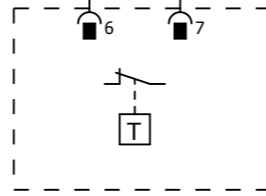

+20HHW10 CT101 -S01

PYROMETER  
HEITRONICS KT19 69D

Spoločný prístroj s +20HBK20 CT001 -B01

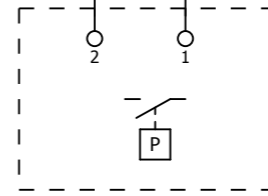

+20HHW10 CP101 -S01

PYROMETER  
NORGEN/HERION

+20CBC01 CE101  
výsipka Napájanie OK

+20CBC01 CE102  
Nizka hladina vody vo vysypke- Napájanie OK

96.2:C

-X02:49

↓ 24VOK

97.3:C

-F13:5

↓ 230VOK1

97.3:D

-F13:6

↓ 230VOK2

© Copyright SIEMENS s.r.o. 2015

Revízia	Dátum	Meno	Datum
		Schválil	6/2016
		Kontroloval	
		Vypracoval	

Zákazník:	Odvoz a likvidácia odpadu a.s.
Zákazka:	Riadenie rošta

**SIEMENS**  
SIEMENS s.r.o. ,Lamačská cesta 3/A  
841 04 Bratislava - SK

**Rozvádzač / Zklz odpadu a sek. Vzduchu**  
  
**DI karta 5-8**

REV: 6/2016 PSV	=
Arch. číslo: P.02091.01	+20CBC01
	List 98
	Listov 5

-A15.3  
Rack X  
Slot Y

6ES7134-6GD00-0BA1 + BU15-P16+A0+2B

AI 4xI 2-/4-wire ST

SIEMENS

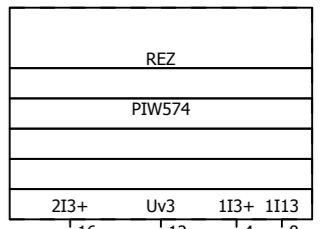
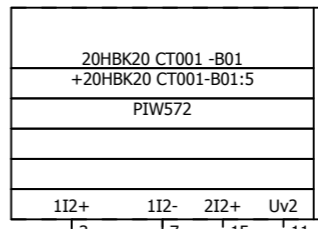
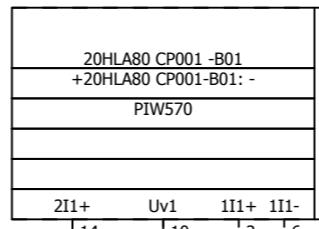
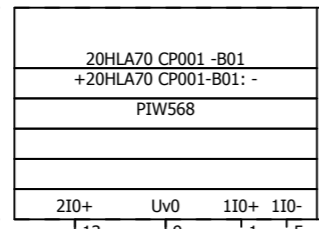
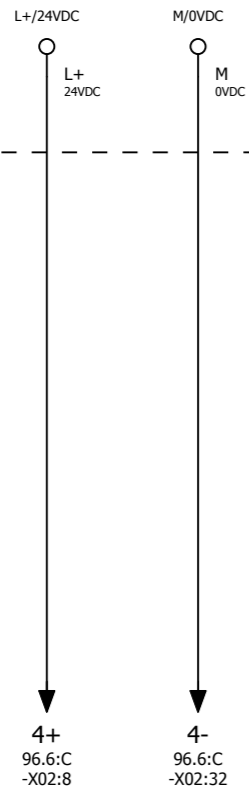

-TE

-TE

-TE

-20CBC01:6003  
801 RD BU

-20CBC01:6004  
801 RD BU

-20CBC01:6005  
/98.4:C  
802 YE GY RD BU

+20CBC01 GH001-X01

-20CBC01GH001:6000  
802 YE GN RD BU

+20HLA70 CP001 -B01  
4-20mA = 0 - 60 mbar  
Siemens Sitrans P 7MF4013  
Tlak sekv. Vpredu

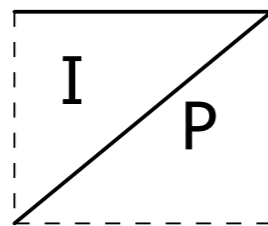

+20HLA80 CP001 -B01  
4-20mA = 0 - 60 mbar  
Siemens Sitrans P 7MF4013  
Tlak sekv. Vzadu

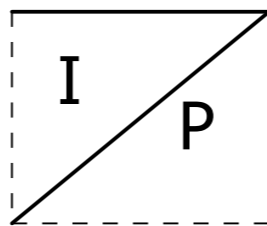

+20HBK20 CT001 -B01  
PYROMETER  
HEITRONICS KT19 69D

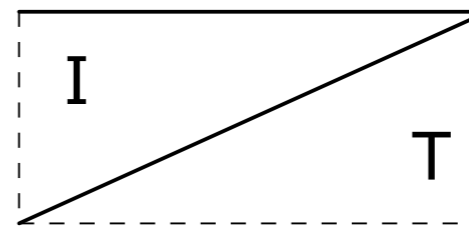

Spoločný prístroj s +20HHW10 CT101 -S01  
Spoločný prístroj s +20HBK20 CT001 -B01

© Copyright SIEMENS s.r.o. 2015

Revizia	Dátum	Meno	Datum
		Schválil	6/2016
		Kontroloval	
		Vypracoval	

Zákazník:	Odvoz a likvidácia odpadu a.s.
Zákazka:	Riadenie rošta

**SIEMENS**  
SIEMENS s.r.o. „Lamačská cesta 3/A  
841 04 Bratislava - SK

**Rozvádzač / Zklz odpadu a sek. Vzduchu**  
**AI karta**

REV: 6/2016 PSV	=
Arch. číslo: P.02091.01	+20CBC01
	List 104
	Listov 5

© Copyright SIEMENS s.r.o. 2015

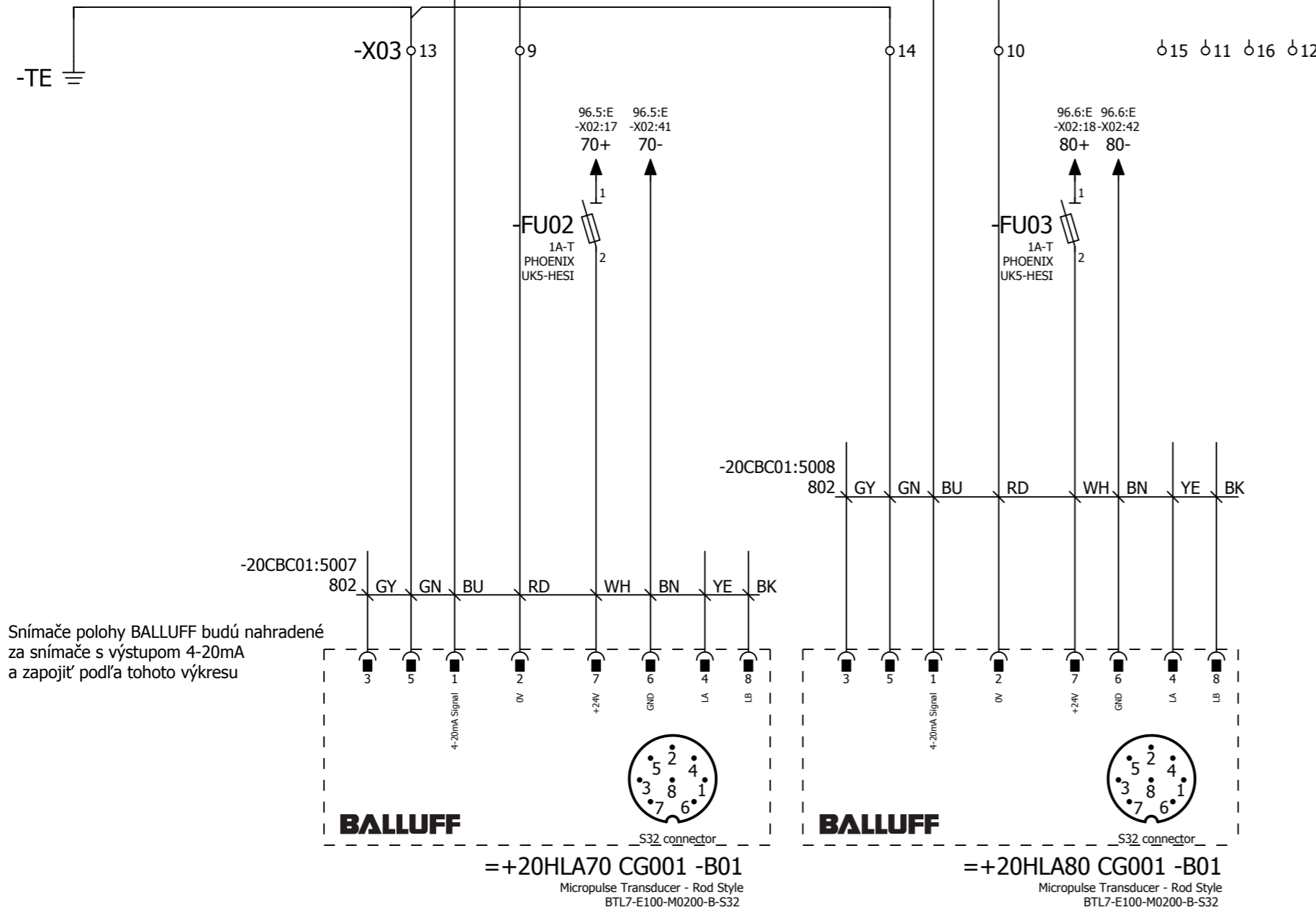
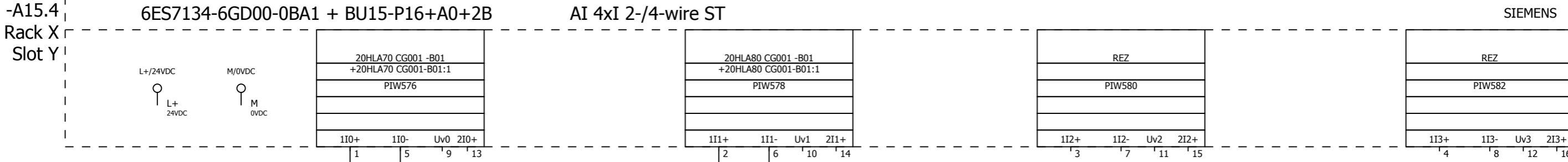

Vypracoval Tomáš Sivok		Zákazník: Odvoz a likvidácia odpadu a.s.		<b>SIEMENS</b>		Rozvádzač / Zklz odpadu a sek. Vzduchu		=	
Kontroloval Began		Zákazka: Riadenie rošta		SIEMENS s.r.o. „Lamačská cesta 3/A 841 04 Bratislava - SK		REV: 6/2016 PSV		+20CBC01	
Schválil Began						Arch. číslo: P.02091.01		List 106	
Revízia	Dátum	Meno	Datum			<b>AI karta</b>		Listov 5	
1		2	6/2016	3		4		5	

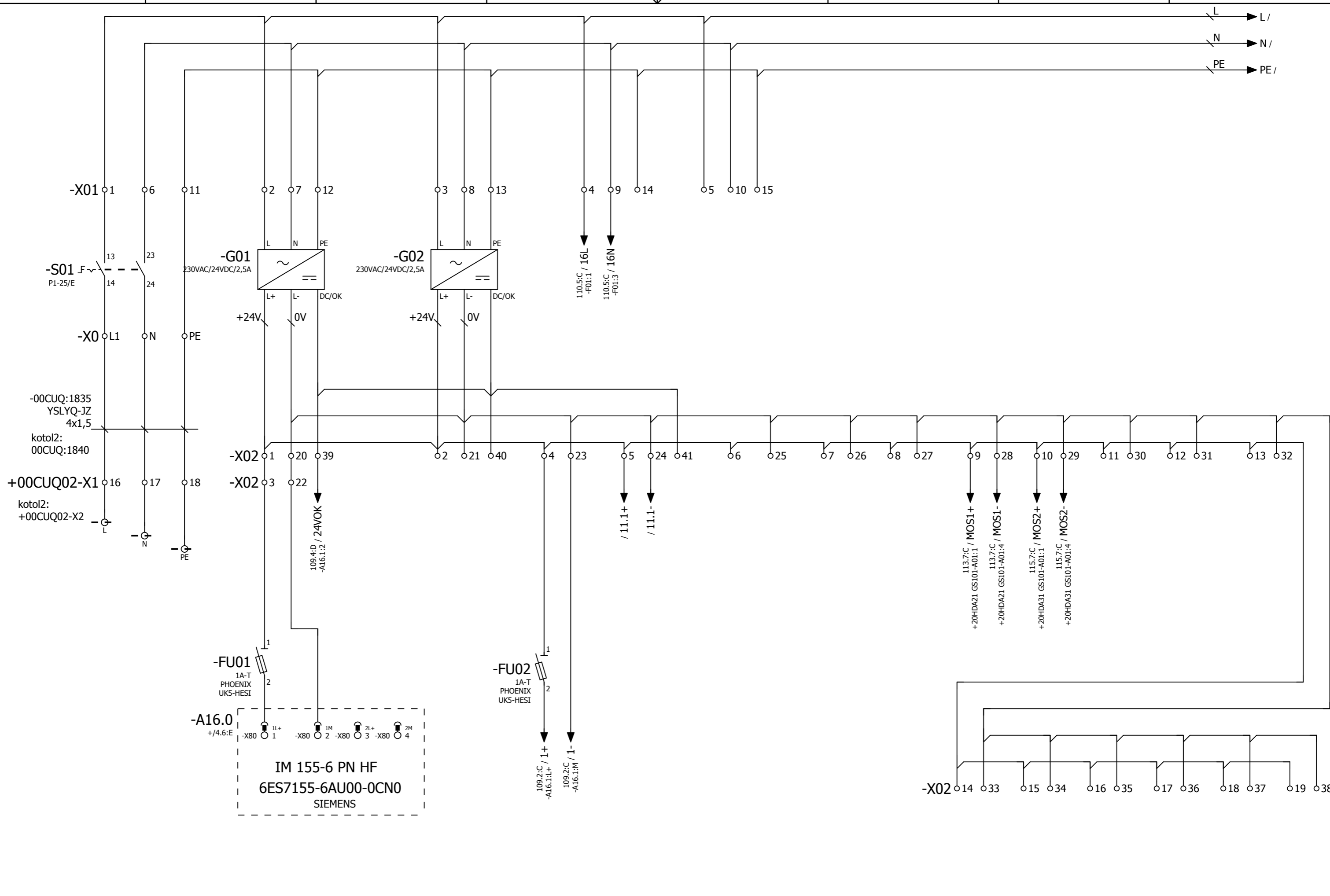

		Vypracoval Tomáš Sivok		Zákazník: Odvoz a likvidácia odpadu a.s.		<b>SIEMENS</b>		Rozvádzač / Škvárový valec a odškvarovač		=	
		Kontroloval Began		Zákazka: Ríadenie rošta		SIEMENS s.r.o. „Lamačská cesta 3/A 841 04 Bratislava - SK		REV: 6/2016 PSV		+20CBC02	
		Schválil Began						Arch. číslo: P.02091.01		List 108	
Revízia	Dátum	Meno	Datum					Napájanie 230V AC/24V DC		Listov 9	
1			6/2016	2	3	4	5	6	7	8	

-A16.1  
/110.1:A  
Rack X  
Slot Y

6ES7131-6BF00-0BA0 + BU15-P16+A10+2D DI 8x24 VDC ST

SIEMENS

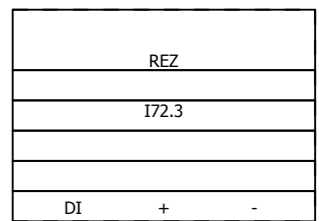
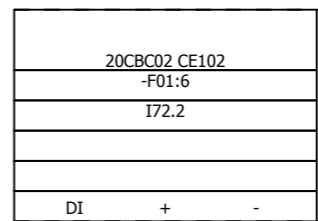
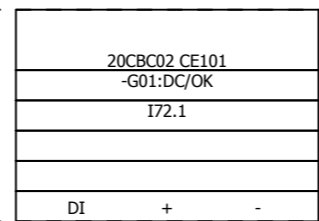
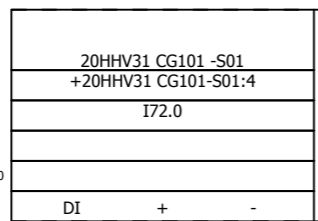
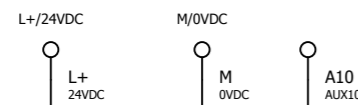

1+  
108.4:E  
-FU02:2

1-  
108.4:E  
-X02:23

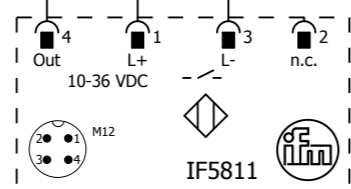
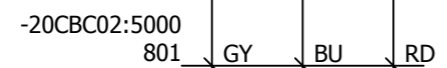

+20HHV31 CG101 -S01  
Sn=7mm

108.3:D / 24VOK  
-X02:39

+20CBC02 CE101  
Škvárový valec a odškvarovač Napájanie Ok

110.6:C / 230VOK1  
-F01:6

110.6:C / 230VOK2  
-F01:5

+20CBC02 CE102  
Odškvarovač hladina - Napájanie OK

© Copyright SIEMENS s.r.o. 2015

Revizia	Dátum	Meno	Datum

Vypracoval	Tomáš Sivok	Zákazník:	Odvoz a likvidácia odpadu a.s.
Kontroloval	Began	Zákazka:	Riadenie rošta
Schválil	Began		
Datum	6/2016		

**SIEMENS**  
SIEMENS s.r.o. ,Lamačská cesta 3/A  
841 04 Bratislava - SK

**Rozvádzač / Škvárový valec a odškvarovač**  
**DI karta 1-4**

REV: 6/2016 PSV	=
Arch. číslo: P.02091.01	+20CBC02
	List 109
	Listov 9

-A16.1  
/109.1:A  
Rack X  
Slot Y

6ES7131-6BF00-0BA0 + BU15-P16+A10+2D DI 8x24 VDC ST

SIEMENS



-20CBC02:5026  
801 RD BU

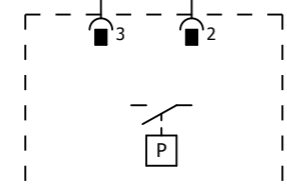

+20HHW40 CP101 -S01  
30mbar  
Kromschroder DG.50 UG 3

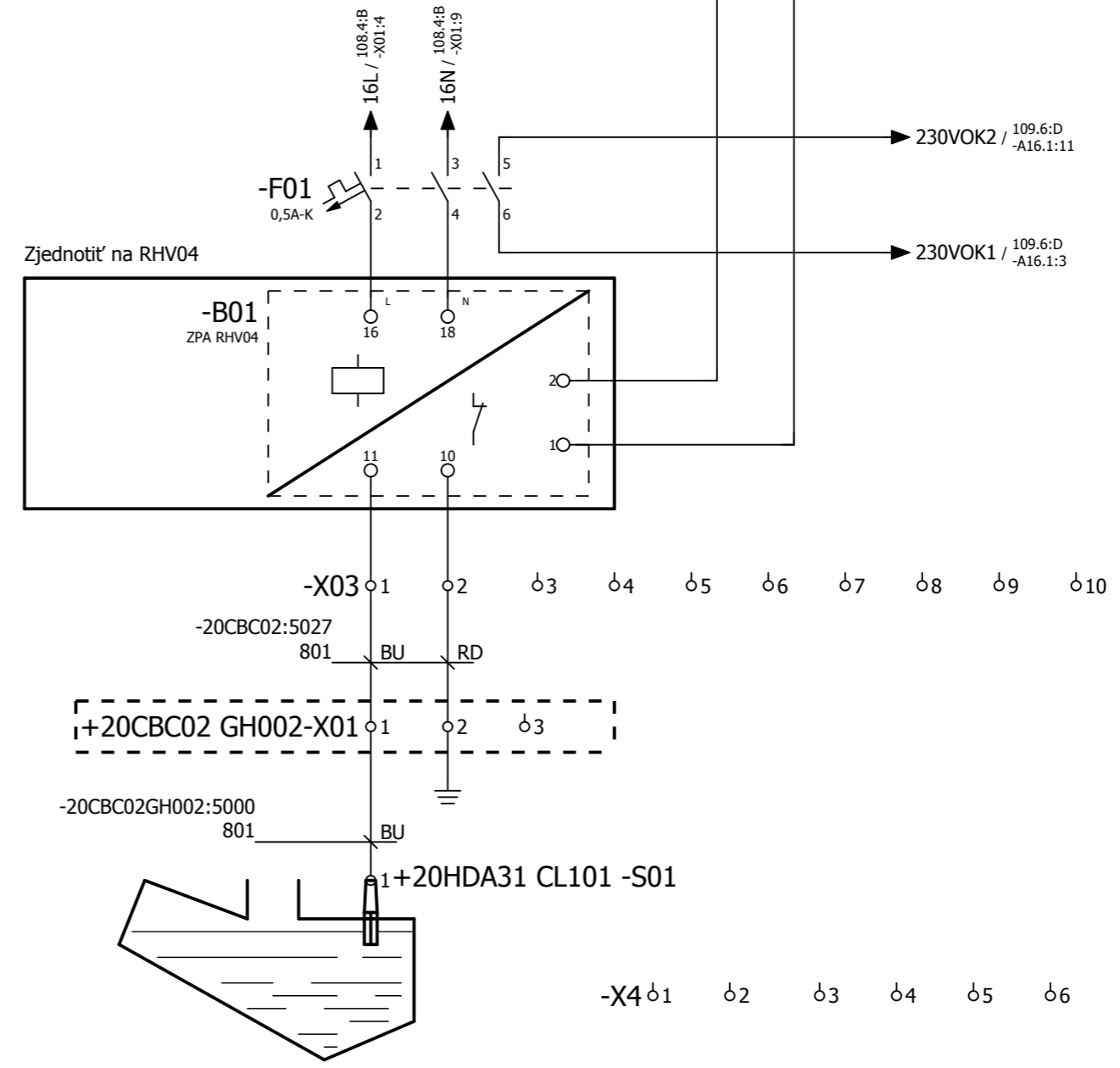

© Copyright SIEMENS s.r.o. 2015

			Vypracoval Tomáš Sivok
			Kontroloval Began
			Schválil Began
Revizia	Dátum	Meno	Datum 6/2016

Zákazník:	Odvoz a likvidácia odpadu a.s.
Zákazka:	Riadenie rošta

**SIEMENS**  
SIEMENS s.r.o. ,Lamačská cesta 3/A  
841 04 Bratislava - SK

Rozvádzač / Škvárový valec a odškvarovač  
**DI karta 5-8**

REV: 6/2016 PSV  
Arch. číslo: P.02091.01

=	+20CBC02
List	110
Listov	9

1 2 3 4 5 6 7 8

-A16.2  
/112.1:A  
Rack X  
Slot Y

6ES7132-6BF00-0BA0 + BU15-P16+A0+2B DQ 8x24 VDC/0,5A ST

SIEMENS

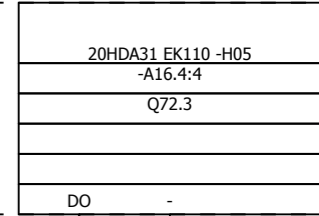
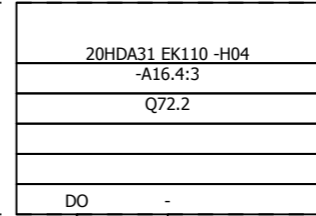
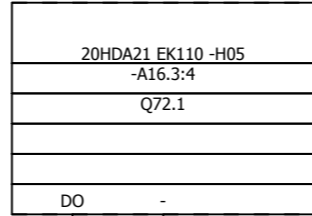
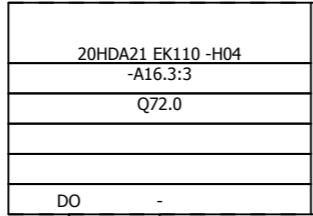

204  
113.6:C  
-A16.3:3

205  
113.7:C  
-A16.3:4

304  
115.6:C  
-A16.4:3

305  
115.7:C  
-A16.4:4

20HHH22 EK110 -H04

20HHH22 EK110 -H05

20HHC22 EK110 -H04

20HHC22 EK110 -H05

© Copyright SIEMENS s.r.o. 2015

			Vypracoval	Tomáš Sivok
			Kontroloval	Began
			Schválil	Began
Revízia	Dátum	Meno	Datum	6/2016

Zákazník: Odvoz a likvidácia odpadu a.s.  
Zákazka: Ríadenie rošta

**SIEMENS**  
SIEMENS s.r.o. „Lamačská cesta 3/A  
841 04 Bratislava - SK

Rozvádzač / Škvárový valec a odškvarovač

4DO karta

=	
REV: 6/2016 PSV	+20CBC02
Arch. číslo: P.02091.01	List 111
	Listov 9

1 2 3 4 5 6 7 8



-A16.2  
/111.1:A  
Rack X  
Slot Y

6ES7132-6BF00-0BA0 + BU15-P16+A0+2B DQ 8x24 VDC/0,5A ST

SIEMENS

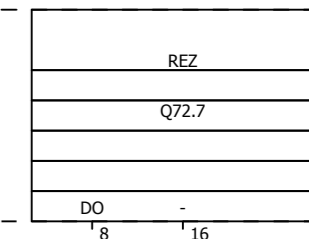
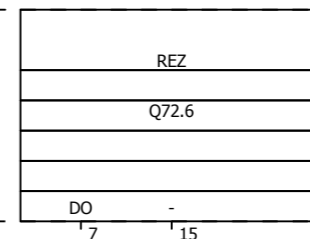
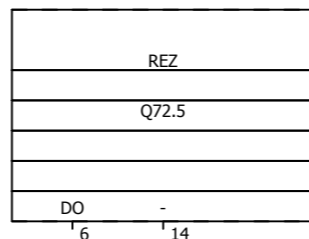
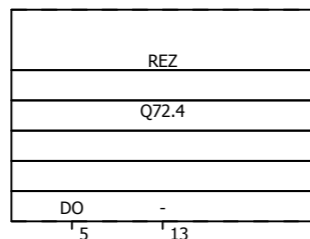

© Copyright SIEMENS s.r.o. 2015

			Vypracoval Tomáš Sivok
			Kontroloval Began
			Schválil Began
Revízia	Dátum	Meno	Datum 6/2016

Zákazník:	Odvoz a likvidácia odpadu a.s.
Zákazka:	<b>Riadenie rošta</b>

**SIEMENS**  
SIEMENS s.r.o. „Lamačská cesta 3/A  
841 04 Bratislava - SK

**Rozvádzač / Škvárový valec a odškvarovač**  
**4DO karta**

REV: 6/2016 PSV	=
Arch. číslo: P.02091.01	+20CBC02
	List 112
	Listov 9

6ES7131-6BF00-0BA0 + BU15-P16+A10+2B DI 8x24 VDC ST

SIEMENS

-A16.3  
/114.1:A  
Rack X  
Slot Y

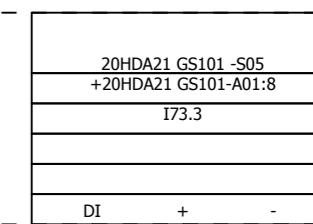
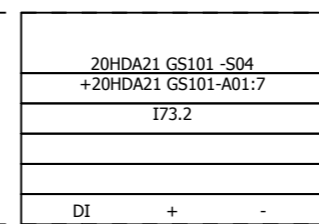
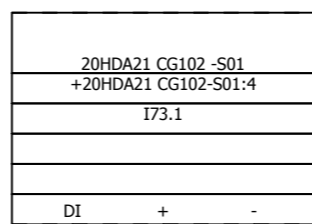
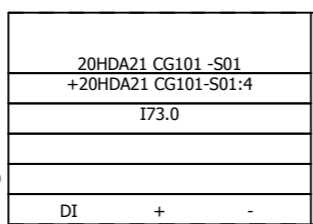
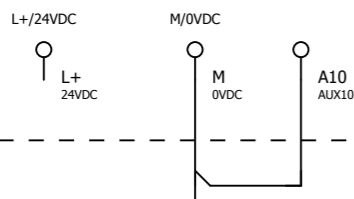

-20CBC02:5001  
801 GY BU RD

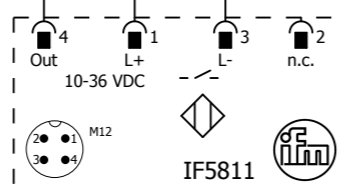

+20HDA21 CG101 -S01  
Sn=7mm

-20CBC02:5002  
801 GY BU RD

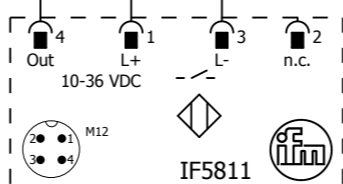

+20HDA21 CG102 -S01  
Sn=7mm

-20CBC02:5003  
/114.3:D  
802 GY BU RD YE

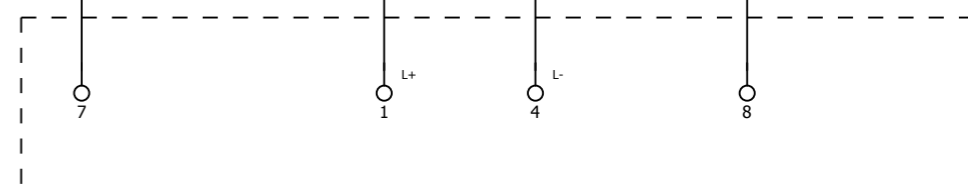

+20HDA21 GS101 -A01  
/114.2:D  
škvárový valec  
Miestna ovládací skrinka

20HDA21 GS101 -S04  
Zasunúť

20HDA21 GS101 -S05  
Vysunúť

© Copyright SIEMENS s.r.o. 2015

Revizia	Dátum	Meno	Datum	6/2016
		Schválil	Began	
		Kontroloval	Began	
		Vypracoval	Tomáš Sivok	

Zákazník:	Odvoz a likvidácia odpadu a.s.
Zákazka:	Riadenie rošta

**SIEMENS**  
SIEMENS s.r.o. ,Lamačská cesta 3/A  
841 04 Bratislava - SK

Rozvádzač / Škvárový valec a odškvarováč  
**DI karta 1-4**

REV: 6/2016 PSV	=
Arch. číslo: P.02091.01	+20CBC02
	List 113
	Listov 9

-A16.3  
/113.1:A  
Rack X  
Slot Y

6ES7131-6BF00-0BA0 + BU15-P16+A10+2B DI 8x24 VDC ST

SIEMENS



-20CBC02:5003  
/113.6:D  
802

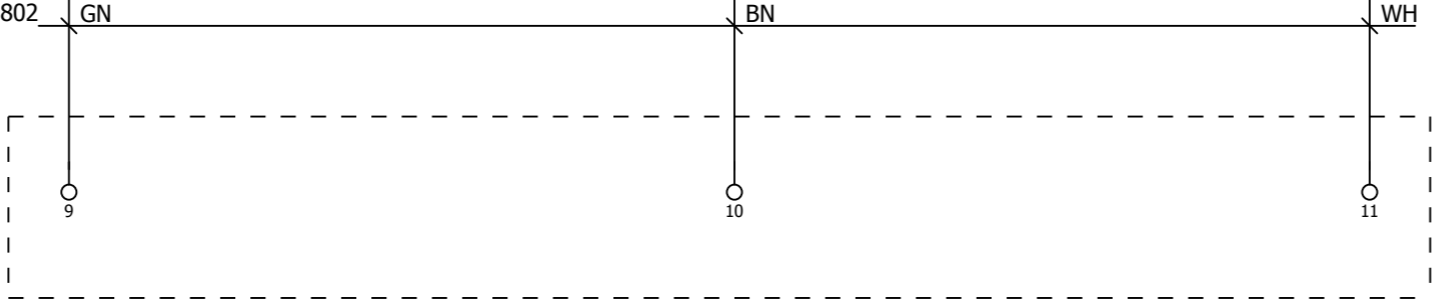

+20HDA21 GS101 -A01  
/113.6:D  
škvárový valec  
Miestna ovládacia skrinka

20HDA21 GS101 -S03  
Nieje STOP

20HDA21 GS101 -S01  
Auto

20HDA21 GS101 -S02  
Pomaly

© Copyright SIEMENS s.r.o. 2015

Vypracoval Tomáš Sivok		Zákazník: Odvoz a likvidácia odpadu a.s.		<b>SIEMENS</b> SIEMENS s.r.o. „Lamačská cesta 3/A“ 841 04 Bratislava - SK	Rozvádzač / Škvárový valec a odškarovad = +20CBC02
Kontroloval Began		Zákazka: Riadenie rošta			
Schválil Began					
Revizia	Dátum	Meno	Datum	6/2016	
1		2		3	

DI karta 5-8

REV: 6/2016 PSV  
Arch. číslo: P.02091.01

-A16.4  
/116.1:A  
Rack X  
Slot Y

6ES7131-6BF00-0BA0 + BU15-P16+A10+2B DI 8x24 VDC ST

SIEMENS

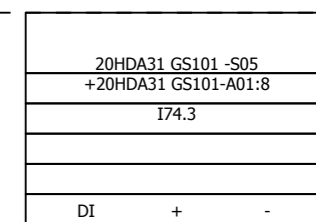
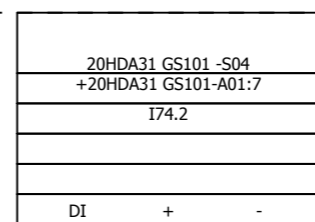
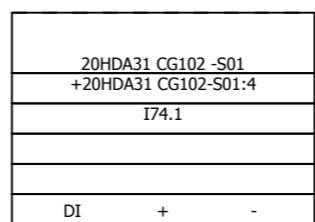
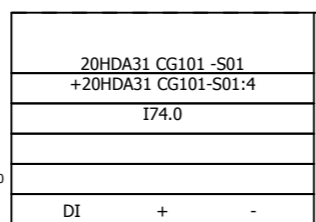
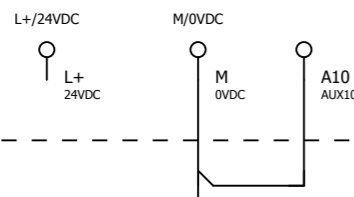

-20CBC02:5004  
801 GY BU RD

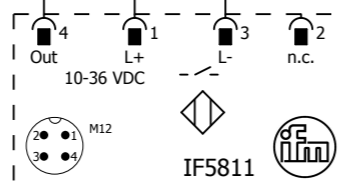

+20HDA31 CG101 -S01  
Sn=7mm

-20CBC02:5005  
801 GY BU RD

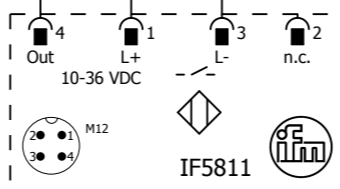

+20HDA31 CG102 -S01  
Sn=7mm

-20CBC02:5006  
/116.3:D  
802 GY BU RD YE

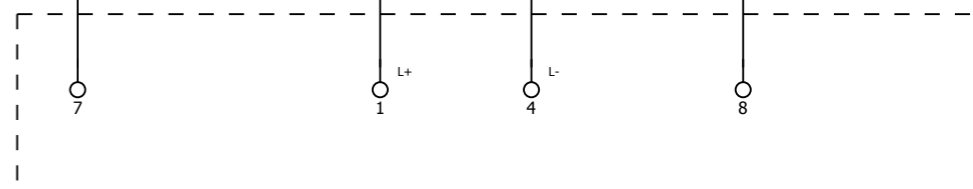

+20HDA31 GS101 -A01  
/116.2:D  
odškvarovač  
Miestna ovládacía skrinka

20HDA31 GS101 -S04  
Zasunúť

20HDA31 GS101 -S05  
Vysunúť

© Copyright SIEMENS s.r.o. 2015

Revizia	Dátum	Meno	Datum

Zákazník:	Odvoz a likvidácia odpadu a.s.
Zákazka:	Riadenie rošta

**SIEMENS**  
SIEMENS s.r.o. ,Lamačská cesta 3/A  
841 04 Bratislava - SK

**Rozvádzač / Škvárový valec a odškvarovač**  
**DI karta 1-4**

REV: 6/2016 PSV	
Arch. číslo: P.02091.01	
List 115	
Listov 9	

-A16.4  
/115.1:A  
Rack X  
Slot Y

6ES7131-6BF00-0BA0 + BU15-P16+A10+2B DI 8x24 VDC ST

SIEMENS

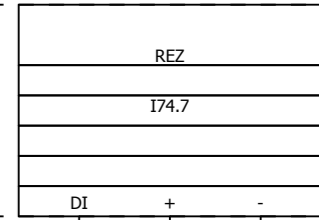
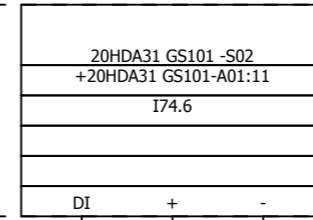
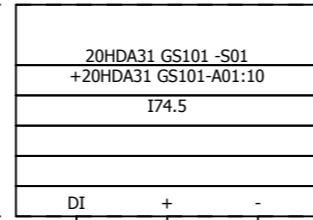
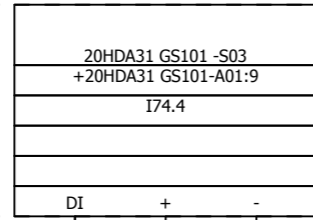

-20CBC02:5006  
/115.6:D  
802

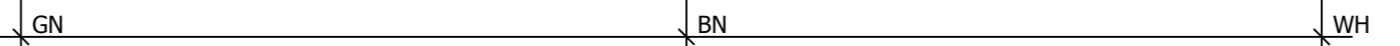

9

10

11

+20HDA31 GS101 -A01  
/115.6:D  
odškvarovač  
Miestna ovládacia skrinka

20HDA31 GS101 -S03  
Nieje STOP

20HDA31 GS101 -S01  
Auto

20HDA31 GS101 -S02  
Pomaly

© Copyright SIEMENS s.r.o. 2015

			Vypracoval Tomáš Sivok Kontroloval Began Schválil Began Revizia    Dátum    Meno    Datum    6/2016	Zákazník: Odvoz a likvidácia odpadu a.s. Zákazka:    Riadenie rošta	<b>SIEMENS</b> SIEMENS s.r.o. „Lamačská cesta 3/A 841 04 Bratislava - SK	<b>Rozvádzač / Škvárový valec a odškvarovač</b>  <b>DI karta 5-8</b>	= +20CBC02 Arch. číslo: P.02091.01 Listov 9
--	--	--	--	--	--	--	--

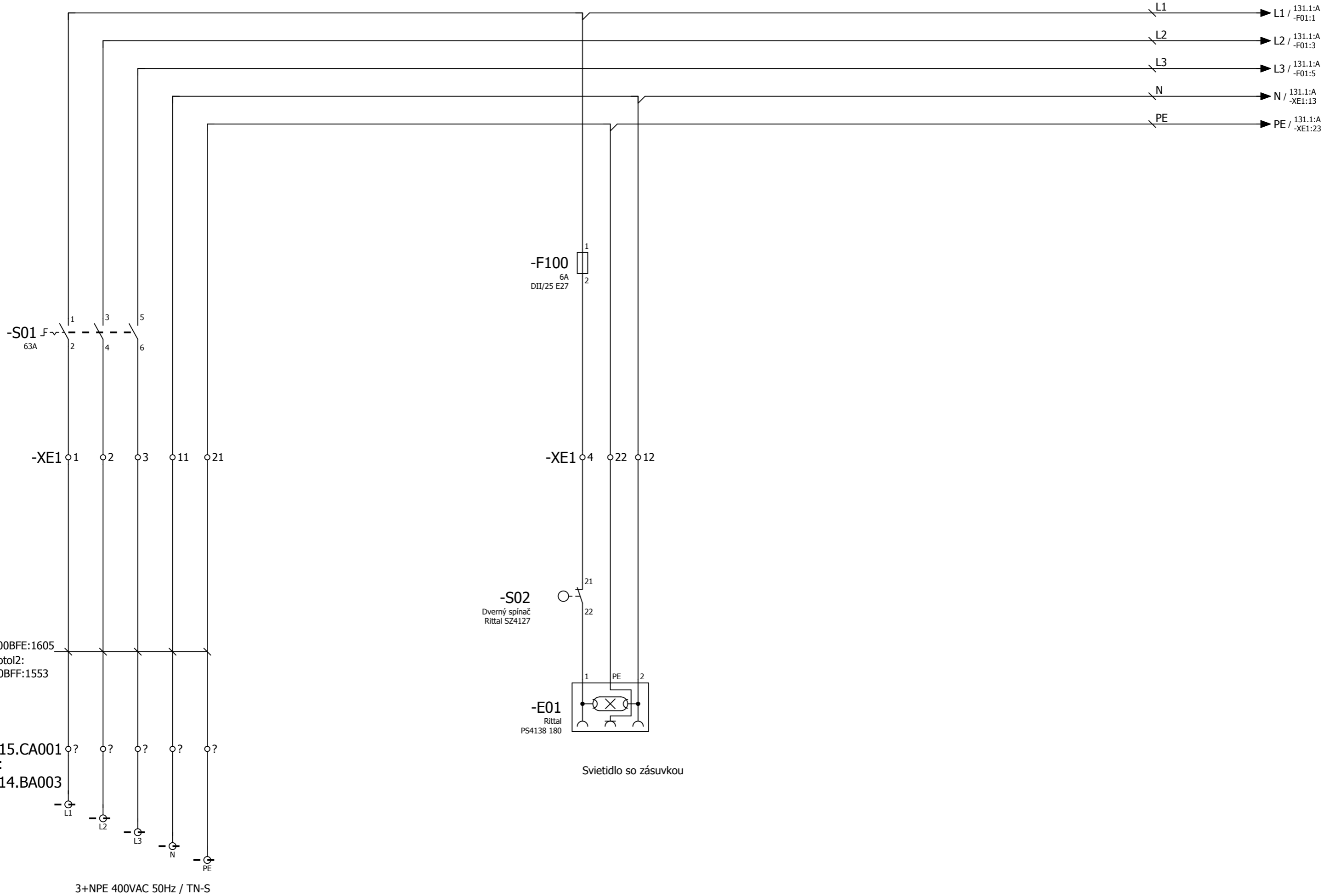

			Vypracoval Tomáš Sivok
			Kontroloval Began
			Schválil Began
Revizia	Dátum	Meno	Datum 6/2016

Zákazník: Odvoz a likvidácia odpadu a.s.
Zákazka: Riadenie rošta

**SIEMENS**  
 SIEMENS s.r.o. „Lamačská cesta 3/A  
 841 04 Bratislava - SK

**FU Rozvádzač / SNCR**  
  
**Napájanie 230V AC**

	=
REV: 6/2016 PSV	+20BPD01
Arch. číslo: P.02091.01	List 130
	Listov 15

© Copyright SIEMENS s.r.o. 2015

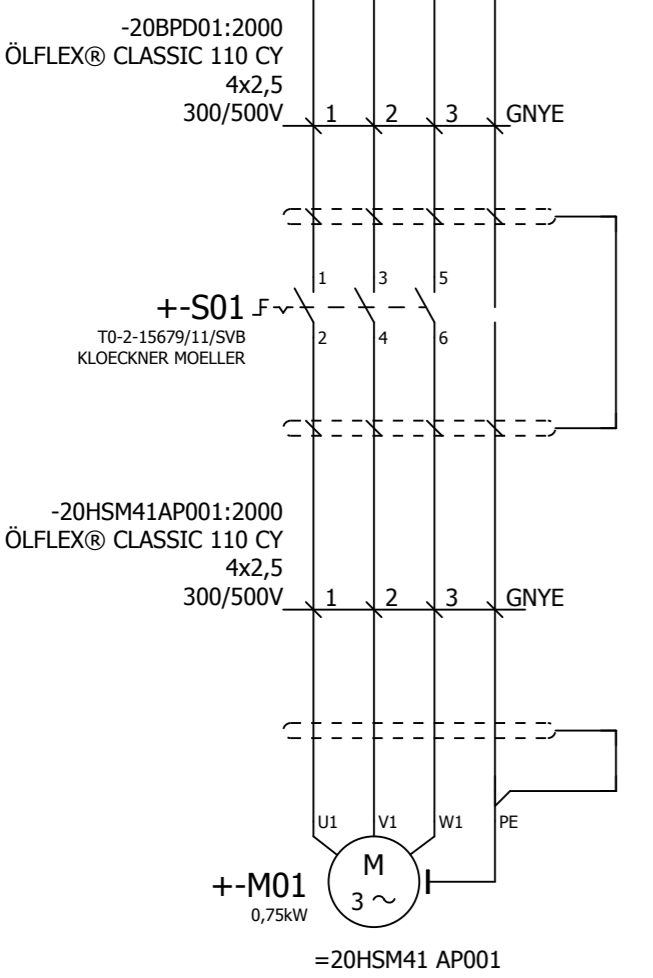
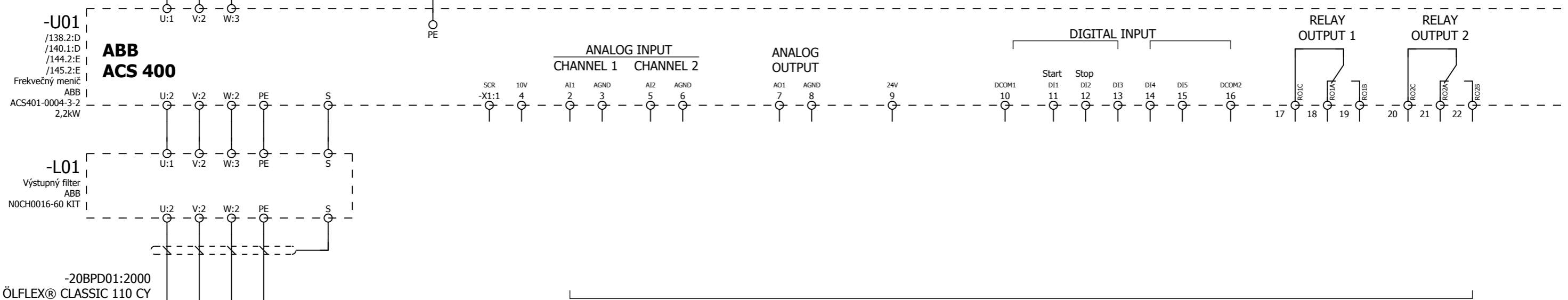
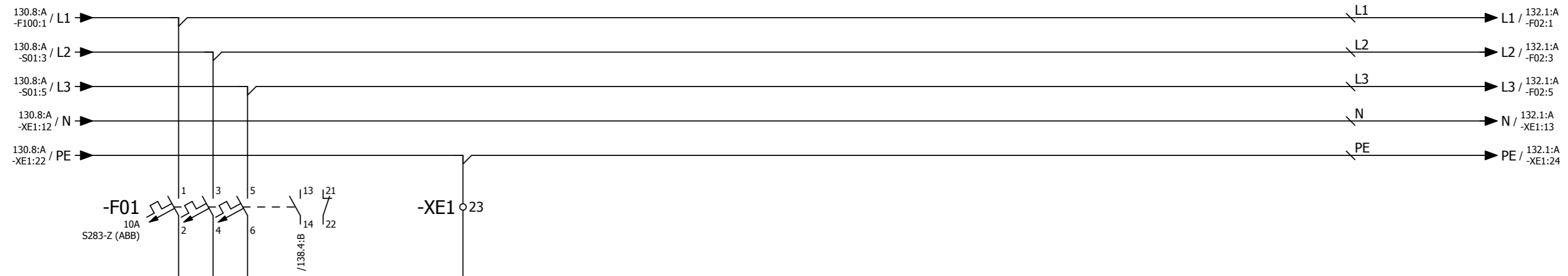

Detail vo výkresoch PLC

Revízia	Dátum	Meno	Datum
			6/2016

Vypracoval Tomáš Sivok Kontroloval Began Schválil Began	Zákazník: Odvoz a likvidácia odpadu a.s. Zákazka: Riadenie rošta
---	---

**SIEMENS**  
 SIEMENS s.r.o. , Lamačská cesta 3/A  
 841 04 Bratislava - SK

**FU Rozvádzač / SNCR**  
  
**NH40H Dávkovacia pumpa 1**

REV: 6/2016 PSV	D1 =	+20BPD01
Arch. číslo: P.02091.01		
	List	131
	Listov	15

© Copyright SIEMENS s.r.o. 2015

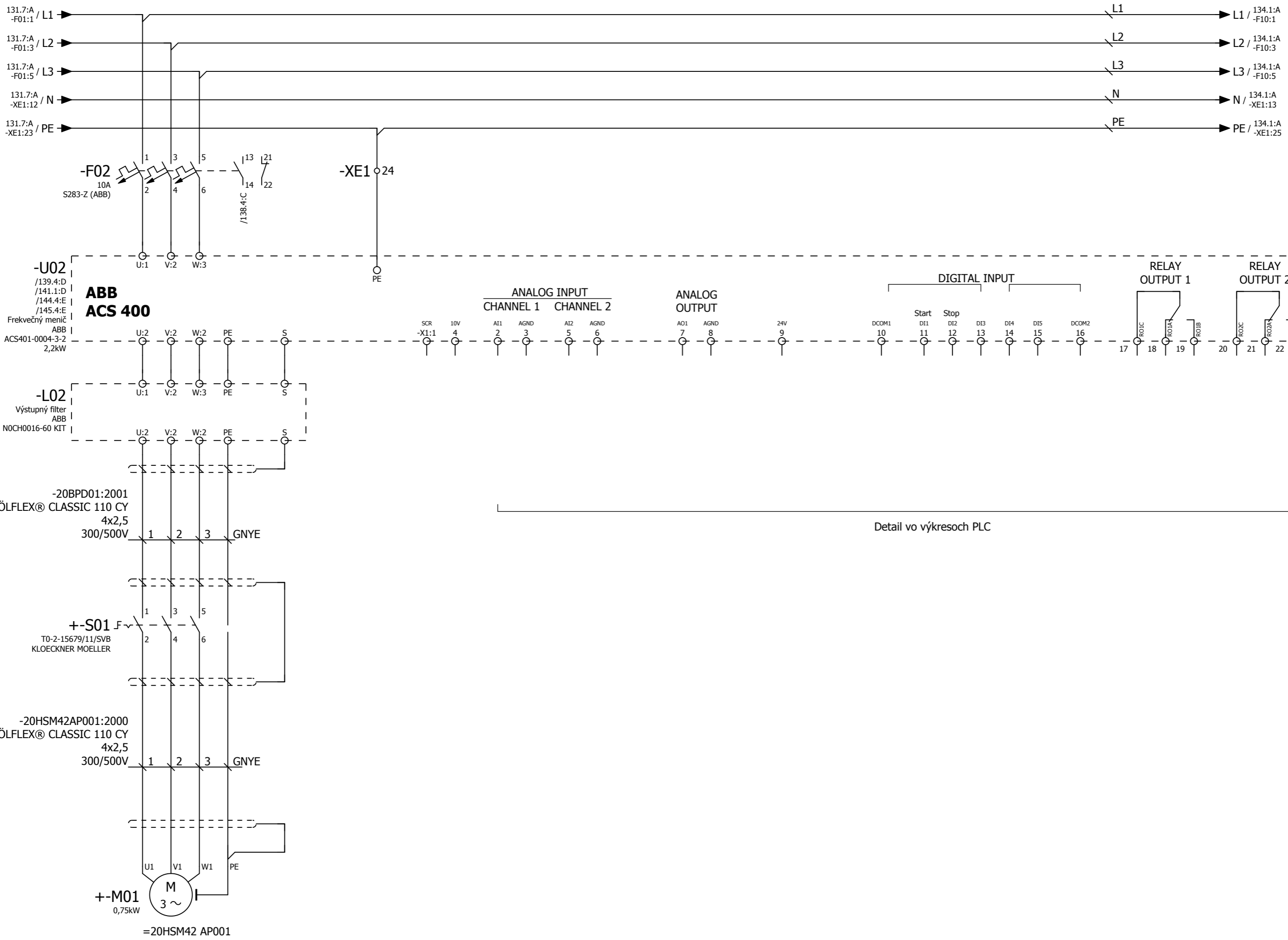

Detail vo výkresoch PLC

Vypracoval Tomáš Sivok		Zákazník: Odvoz a likvidácia odpadu a.s.		<b>SIEMENS</b>		FU Rozvádzač / SNCR		D1 =	
Kontroloval Began		Zákazka: Riadenie rošta		SIEMENS s.r.o. ,Lamačská cesta 3/A 841 04 Bratislava - SK		REV: 6/2016 PSV		+20BPD01	
Schválil Began						Arch. číslo: P.02091.01		List 132	
Revízia	Dátum	Meno	Datum			NH40H Dávkovacia pumpa 2		Listov 15	
1		2	6/2016	3		4		5	



© Copyright SIEMENS s.r.o. 2015

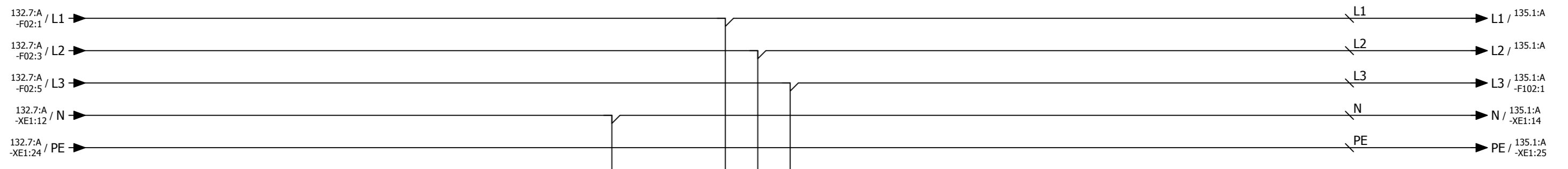

-XE1 13

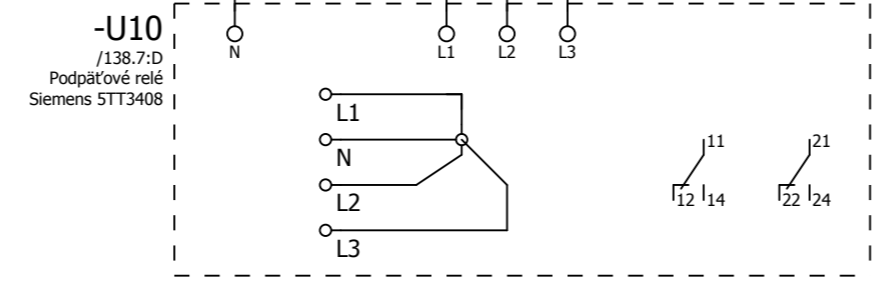
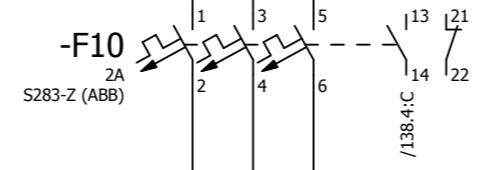

=20BPD01 CE104

			Vypracoval Tomáš Sivok	Zákazník: Odvoz a likvidácia odpadu a.s.
			Kontroloval Began	Zákazka: Riadenie rošta
			Schválil Began	
Revizia	Dátum	Meno	Datum 6/2016	

--	--	--	--	--

**SIEMENS**  
 SIEMENS s.r.o. „Lamačská cesta 3/A  
 841 04 Bratislava - SK

**FU Rozvádzač / SNCR**  
**Sledovanie podpatia**

				=
				+20BPD01
			REV: 6/2016 PSV	List 134
			Arch. číslo: P.02091.01	Listov 15

© Copyright SIEMENS s.r.o. 2015

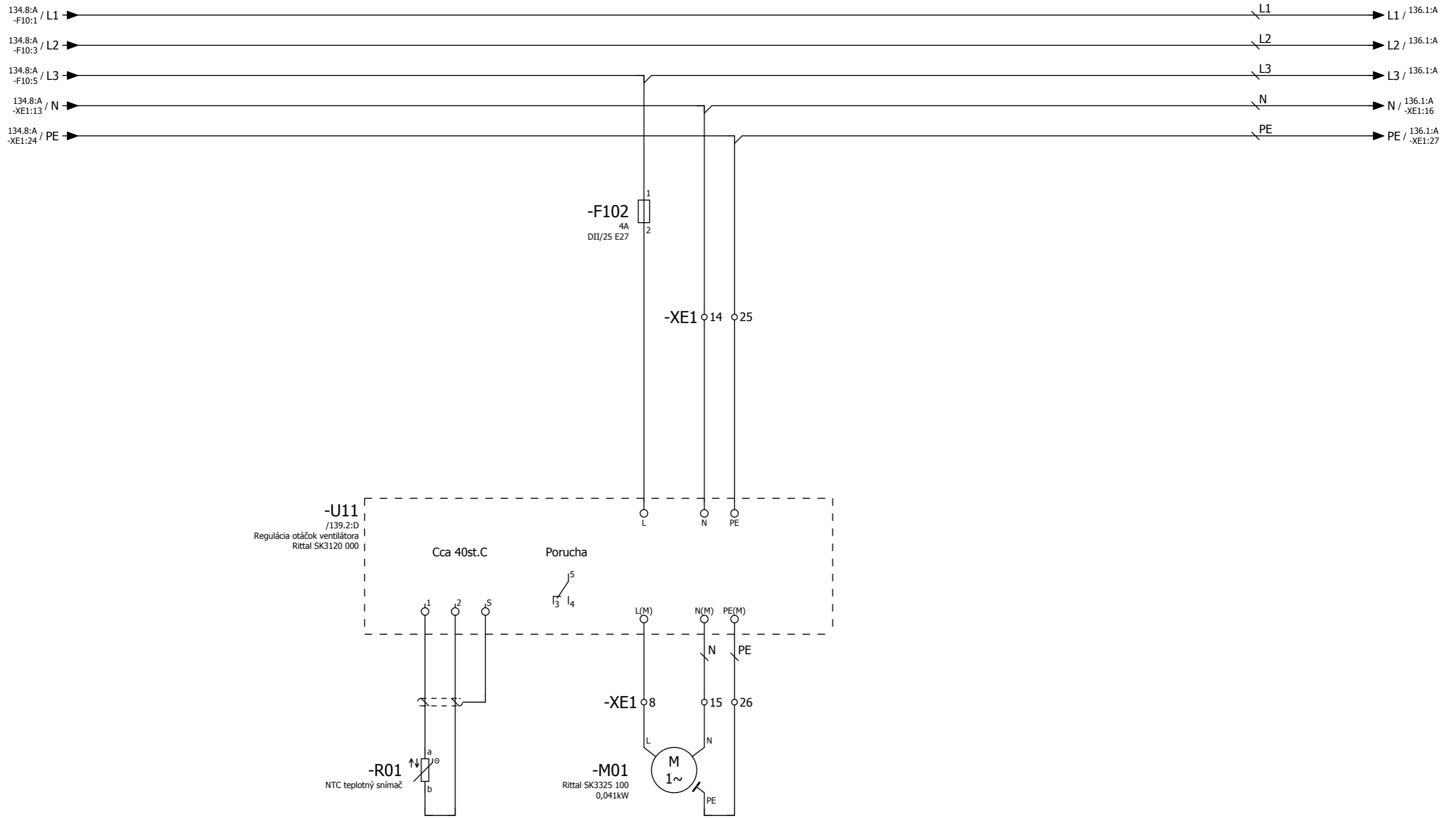

			Vypracoval	Tomáš Sivok
			Kontroloval	Began
			Schválil	Began
Revízia	Dátum	Meno	Datum	6/2016

Zákazník:	Odvoz a likvidácia odpadu a.s.
Zákazka:	Riadenie rošta

**SIEMENS**  
 SIEMENS s.r.o. ,Lamačská cesta 3/A  
 841 04 Bratislava - SK

**FU Rozvádzač / SNCR**  
  
**Ventilátor rozvádzača**

	=
REV: 6/2016 PSV	+20BPD01
Arch. číslo: P.02091.01	List 135
	Listov 15

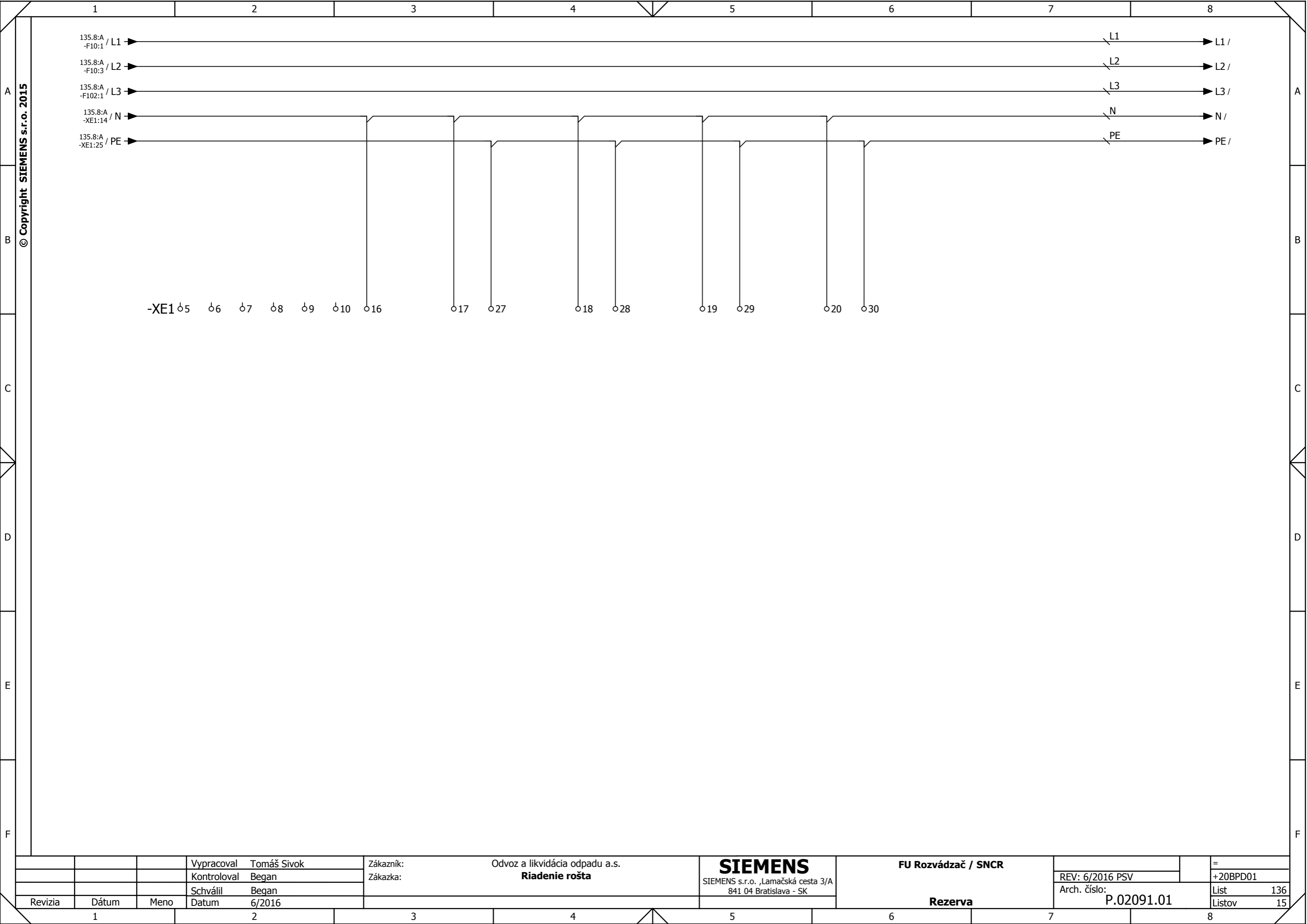

© Copyright SIEMENS s.r.o. 2015

			Vypracoval Tomáš Sivok
			Kontroloval Began
			Schválil Began
Revizia	Dátum	Meno	Datum 6/2016

Zákazník:	Odvoz a likvidácia odpadu a.s.
Zákazka:	Riadenie rošta

**SIEMENS**  
 SIEMENS s.r.o. „Lamačská cesta 3/A  
 841 04 Bratislava - SK

**FU Rozvádzač / SNCR**

**Rezerva**

REV: 6/2016 PSV
Arch. číslo: P.02091.01

=
+20BPD01
List 136
Listov 15

© Copyright SIEMENS s.r.o. 2015

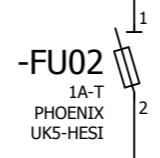
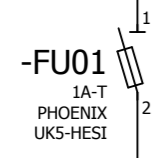
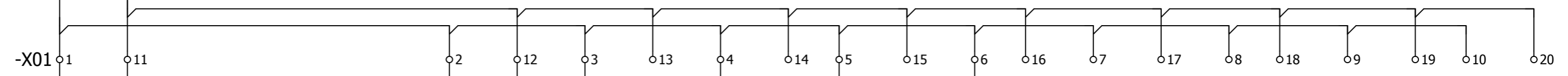
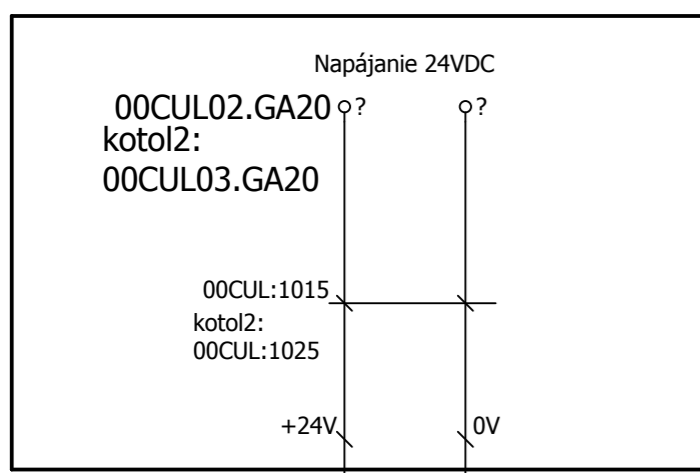

140.4:D / 5+  
-U01-X1:14

141.4:D / 6+  
-U02-X1:14

1+  
138.2:C  
-A51.1:L+

1-  
138.2:C  
-A51.1:M

Ufs1+  
140.6:D  
-X10:1

Ufs2+  
141.6:D  
-X10:3

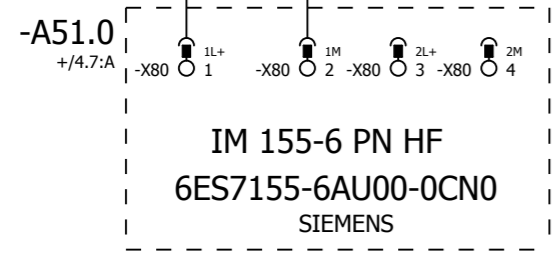

Revizia	Dátum	Meno	Datum
1			6/2016

Vypracoval	Tomáš Sivok
Kontroloval	Began
Schválil	Began

Zákazník:	Odvoz a likvidácia odpadu a.s.
Zákazka:	Riadenie rošta

**SIEMENS**  
SIEMENS s.r.o. „Lamačská cesta 3/A  
841 04 Bratislava - SK

**FU Rozvádzač / SNCR**  
**Napájanie 24V DC**

REV: 6/2016 PSV	=
Arch. číslo: P.02091.01	+20BPD01
	List 137
	Listov 15

-A51.1  
/139.1:A  
Rack X  
Slot Y

6ES7131-6BF00-0BA0 + BU15-P16+A10+2D DI 8x24 VDC ST

SIEMENS

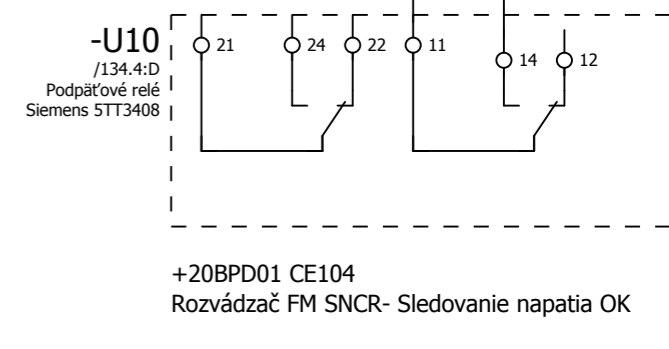
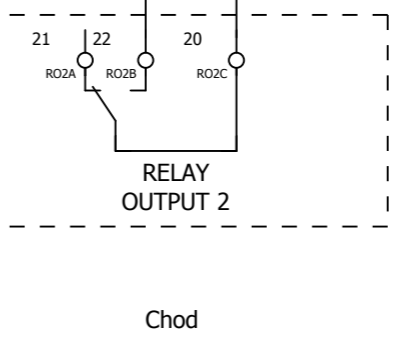
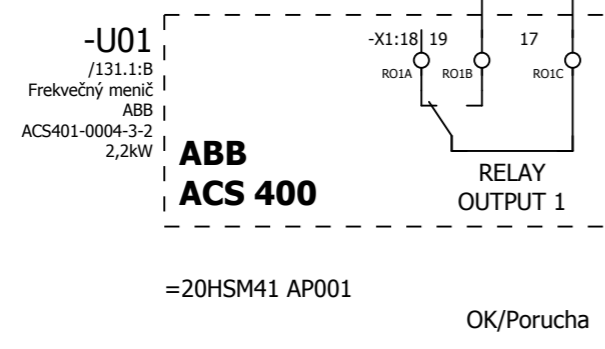
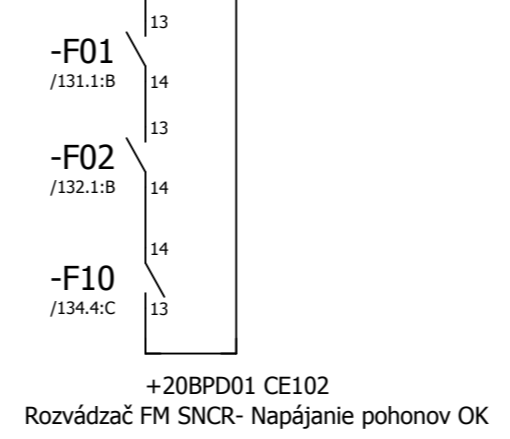
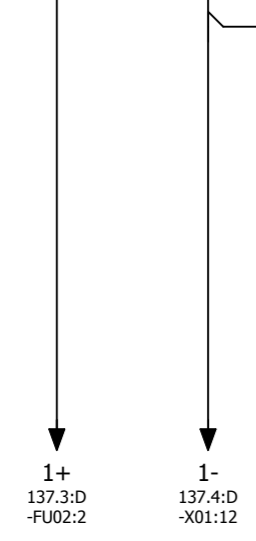
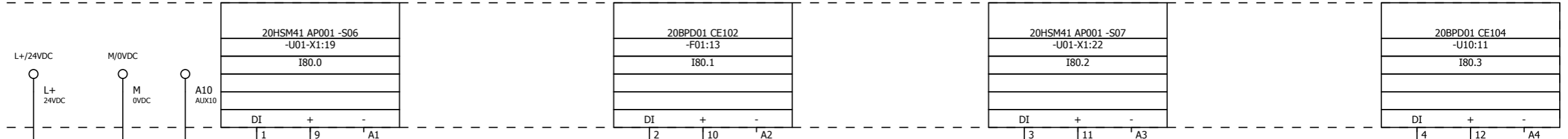

© Copyright SIEMENS s.r.o. 2015

Revízia	Dátum	Meno	Datum	6/2016
		Schválil	Began	
		Kontroloval	Began	
		Vypracoval	Tomáš Sivok	

Zákazník:	Odvoz a likvidácia odpadu a.s.
Zákazka:	Riadenie rošta

**SIEMENS**  
SIEMENS s.r.o. ,Lamačská cesta 3/A  
841 04 Bratislava - SK

**FU Rozvádzač / SNCR**  
**DI karta 1-4**

REV: 6/2016 PSV	=
Arch. číslo: P.02091.01	+20BPD01
	List 138
	Listov 15

© Copyright SIEMENS s.r.o. 2015

-A51.1  
/138.1:A  
Rack X  
Slot Y

# 6ES7131-6BF00-0BA0 + BU15-P16+A10+2D DI 8x24 VDC ST

SIEMENS

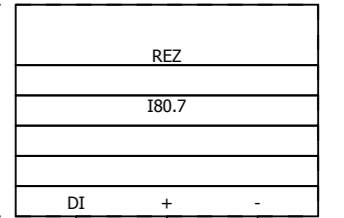
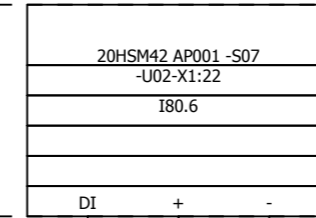
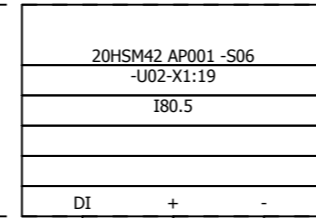
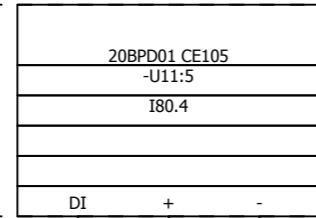

5 13 A5

6 14 A6

7 15 A7

8 16 A8

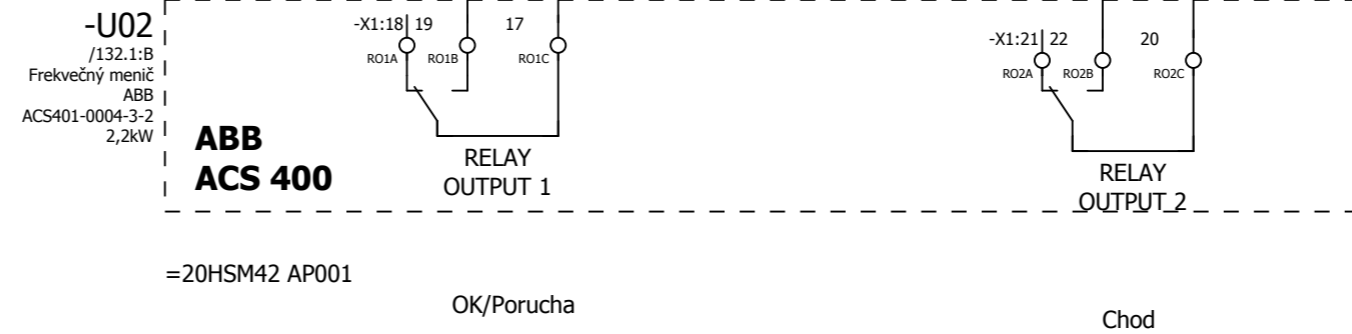
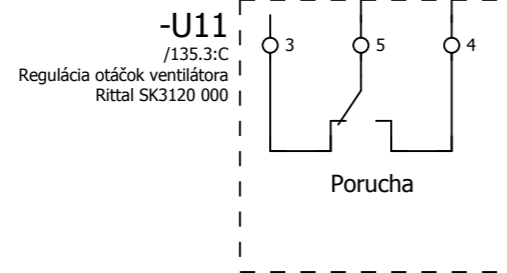

			Vypracoval Tomáš Sivok
			Kontroloval Began
			Schválil Began
Revizia	Dátum	Meno	Datum 6/2016

Zákazník: Odvoz a likvidácia odpadu a.s.
Zákazka: Riadenie rošta

**SIEMENS**  
SIEMENS s.r.o. , Lamačská cesta 3/A  
841 04 Bratislava - SK

**FU Rozvádzač / SNCR**  
  
**DI karta 5-8**

REV: 6/2016 PSV
Arch. číslo: P.02091.01

=
+20BPD01
List 139
Listov 15

-A51.2  
/141.1:A  
Rack X  
Slot Y

6ES7132-6BF00-0BA0 + BU15-P16+A0+2B DQ 8x24 VDC/0,5A ST

SIEMENS

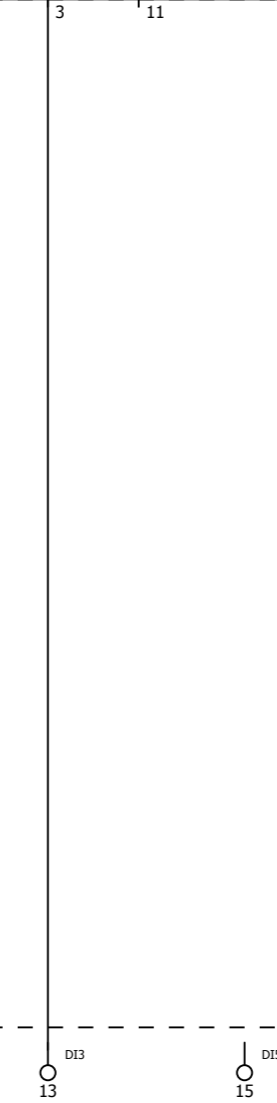
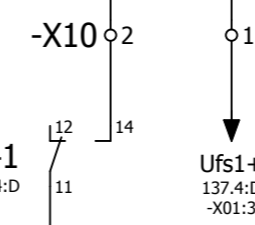
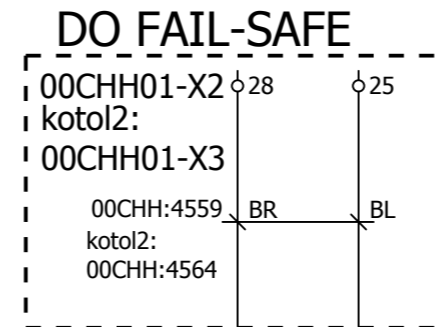
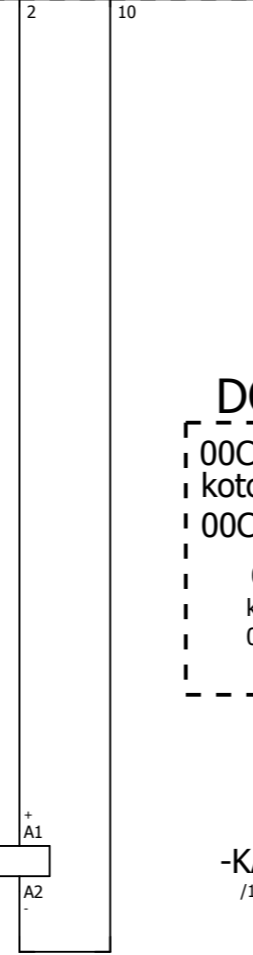
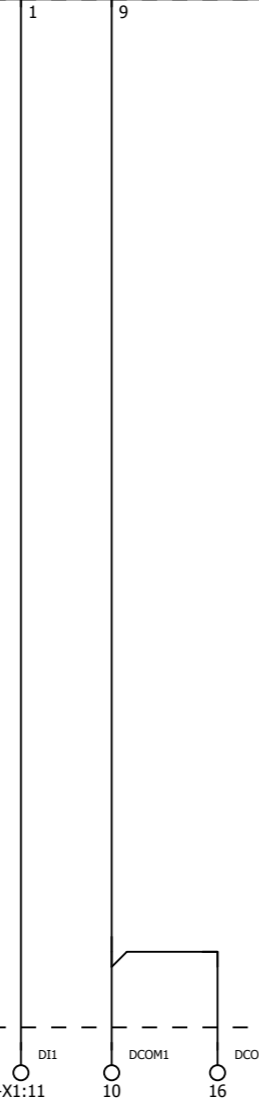
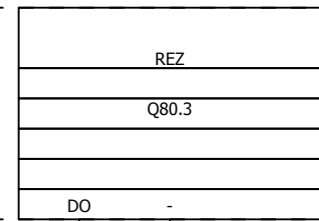
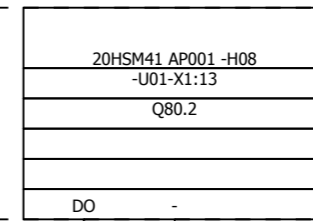
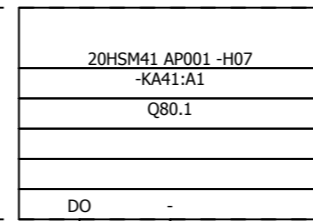
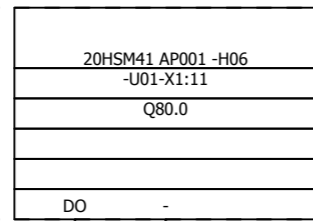

-U01  
/131.1:B  
Frekvenčný menič  
ABB  
ACS401-0004-3-2  
2,2kW

**ABB  
ACS 400**

DIGITAL INPUTS

=20HSM41 AP001

Štart

Control mode  
Factory(1)

STOP

Reverz

Ramp  
selection

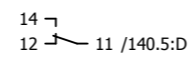

Revizia		Dátum	Meno	Datum	6/2016	Zákazník: Odvoz a likvidácia odpadu a.s.		Zákazka: <b>Riadenie rošta</b>		<b>SIEMENS</b> SIEMENS s.r.o. „Lamačská cesta 3/A 841 04 Bratislava - SK		<b>FU Rozvádzač / SNCR</b>  <b>4DO karta</b>		= +20BPD01 Arch. číslo: <b>P.02091.01</b>		List 140 Listov 15	
1	2	3	4	5	6	7	8	9	10	11	12	13	14	15	16	17	18

© Copyright SIEMENS s.r.o. 2015

-A51.2  
/140.1:A  
Rack X  
Slot Y

6ES7132-6BF00-0BA0 + BU15-P16+A0+2B DQ 8x24 VDC/0,5A ST

SIEMENS

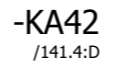
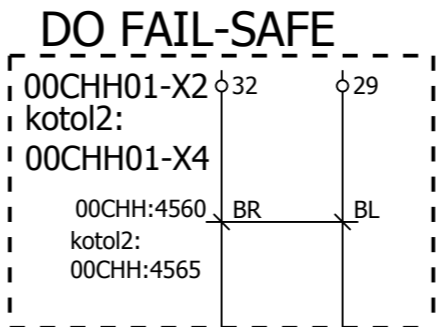
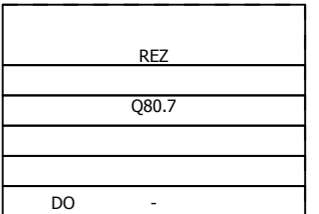
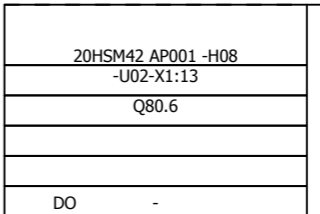
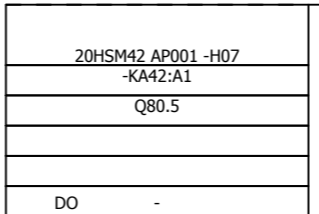
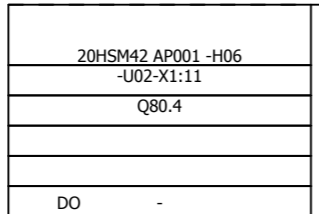

-U02  
/132.1:B  
Frekvenčný menič  
ABB  
ACS401-0004-3-2  
2,2kW

**ABB  
ACS 400**

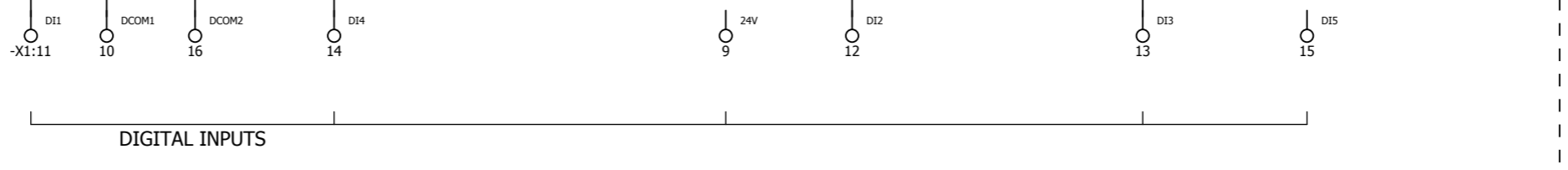

=20HSM41 AP001

Štart

Control mode  
Factory(1)

STOP

Reverz

Ramp  
selection

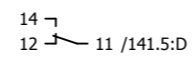

Vypracoval Tomáš Sivok		Zákazník: Odvoz a likvidácia odpadu a.s.		<b>SIEMENS</b>		FU Rozvádzač / SNCR		=	
Kontroloval Began		Zákazka: Riadenie rošta		SIEMENS s.r.o. „Lamačská cesta 3/A 841 04 Bratislava - SK		REV: 6/2016 PSV		+20BPD01	
Schválil Began						Arch. číslo: P.02091.01		List 141	
Revizia	Dátum	Meno	Datum			4DO karta		Listov 15	
1	2	3	4	5	6	7	8		

© Copyright SIEMENS s.r.o. 2015



-A51.3  
/143.1:A  
Rack X  
Slot Y

6ES7131-6BF00-0BA0 + BU15-P16+A10+2B DI 8x24 VDC ST

SIEMENS

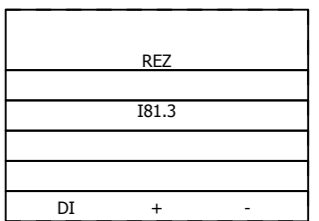
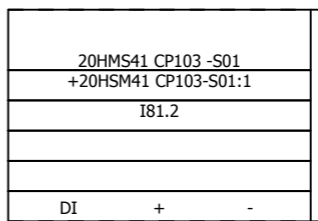
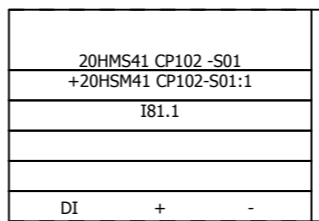
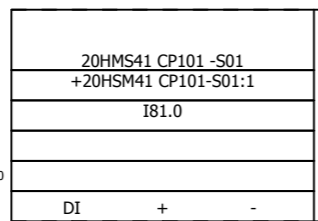
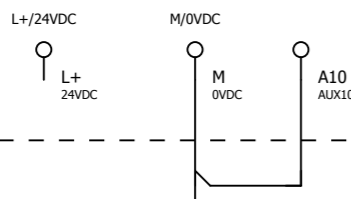

-20BPD01:5001  
801 BU RD

-20BPD01:5002  
801 BU RD

-20BPD01:5003  
801 BU RD

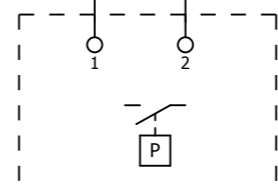
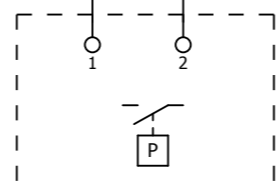
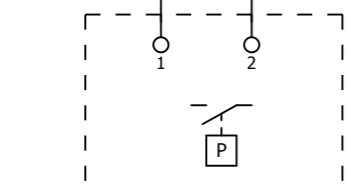

+20HSM41 CP101 -S01  
Fabr Layher 405

+20HSM41 CP102 -S01  
Fabr Layher 405

+20HSM41 CP103 -S01  
Fabr Layher 405

© Copyright SIEMENS s.r.o. 2015

Revizia	Dátum	Meno	Datum
1	2	3	4

Vypracoval Tomáš Sivok Kontroloval Began Schválil Began	Zákazník: Odvoz a likvidácia odpadu a.s. Zákazka: Riadenie rošta
---	---

**SIEMENS**  
SIEMENS s.r.o. ,Lamačská cesta 3/A  
841 04 Bratislava - SK

**FU Rozvádzač / SNCR**  
**DI karta 1-4**

REV: 6/2016 PSV	=
Arch. číslo: P.02091.01	+20BPD01
	List 142
	Listov 15

-A51.3  
/142.1:A  
Rack X  
Slot Y

6ES7131-6BF00-0BA0 + BU15-P16+A10+2B DI 8x24 VDC ST

SIEMENS

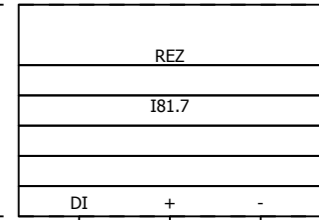
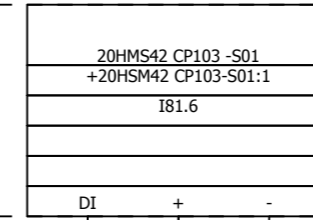
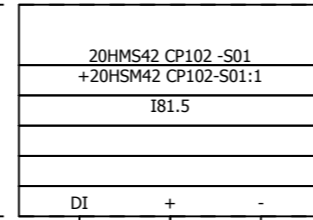
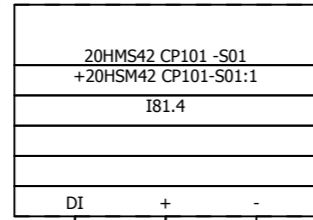

-20BPD01:5004  
801 BU RD

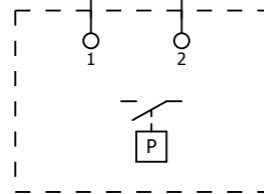

+20HSM42 CP101 -S01  
Fabr Layher 405

-20BPD01:5005  
801 BU RD

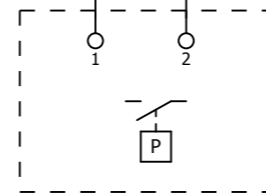

+20HSM42 CP102 -S01  
Fabr Layher 405

-20BPD01:5006  
801 BU RD

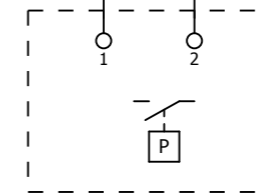

+20HSM42 CP103 -S01  
Fabr Layher 405

© Copyright SIEMENS s.r.o. 2015

			Vypracoval Tomáš Sivok
			Kontroloval Began
			Schválil Began
Revizia	Dátum	Meno	Datum 6/2016

Zákazník:	Odvoz a likvidácia odpadu a.s.
Zákazka:	Riadenie rošta

**SIEMENS**  
SIEMENS s.r.o. ,Lamačská cesta 3/A  
841 04 Bratislava - SK

**FU Rozvádzač / SNCR**  
  
**DI karta 5-8**

	=
REV: 6/2016 PSV	+20BPD01
Arch. číslo: P.02091.01	List 143
	Listov 15

-A51.4  
 Rack X  
 Slot Y

6ES7134-6GD00-0BA1 + BU15-P16+A0+2B

AI 4xI 2-/4-wire ST

SIEMENS

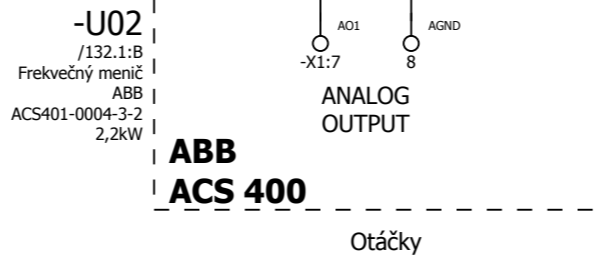
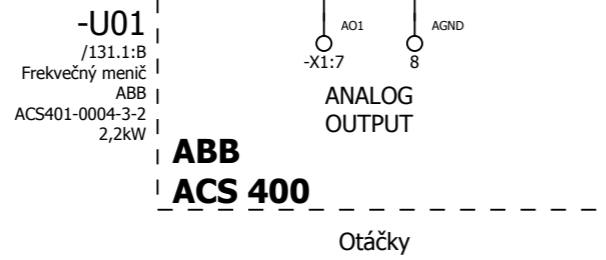
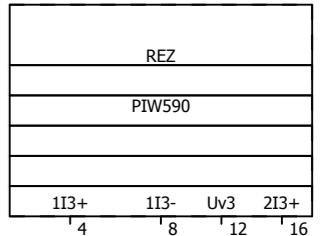
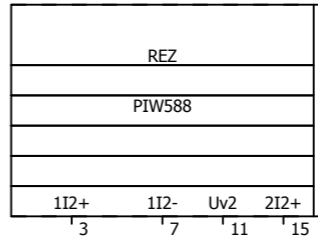
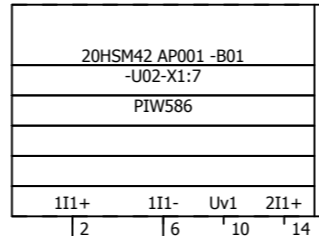
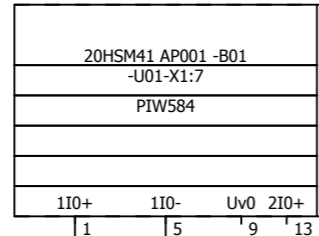
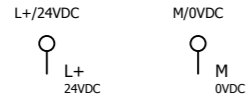

© Copyright SIEMENS s.r.o. 2015

Revizia	Dátum	Meno	Datum
			6/2016

Vypracoval	Tomáš Sivok	Zákazník:	Odvoz a likvidácia odpadu a.s.
Kontroloval	Began	Zákazka:	Riadenie rošta
Schválil	Began		

**SIEMENS**  
 SIEMENS s.r.o. ,Lamačská cesta 3/A  
 841 04 Bratislava - SK

**FU Rozvádzač / SNCR**  
**AI karta**

REV: 6/2016 PSV	=
Arch. číslo: P.02091.01	+20BPD01
	List 144
	Listov 15



© Copyright SIEMENS s.r.o. 2015

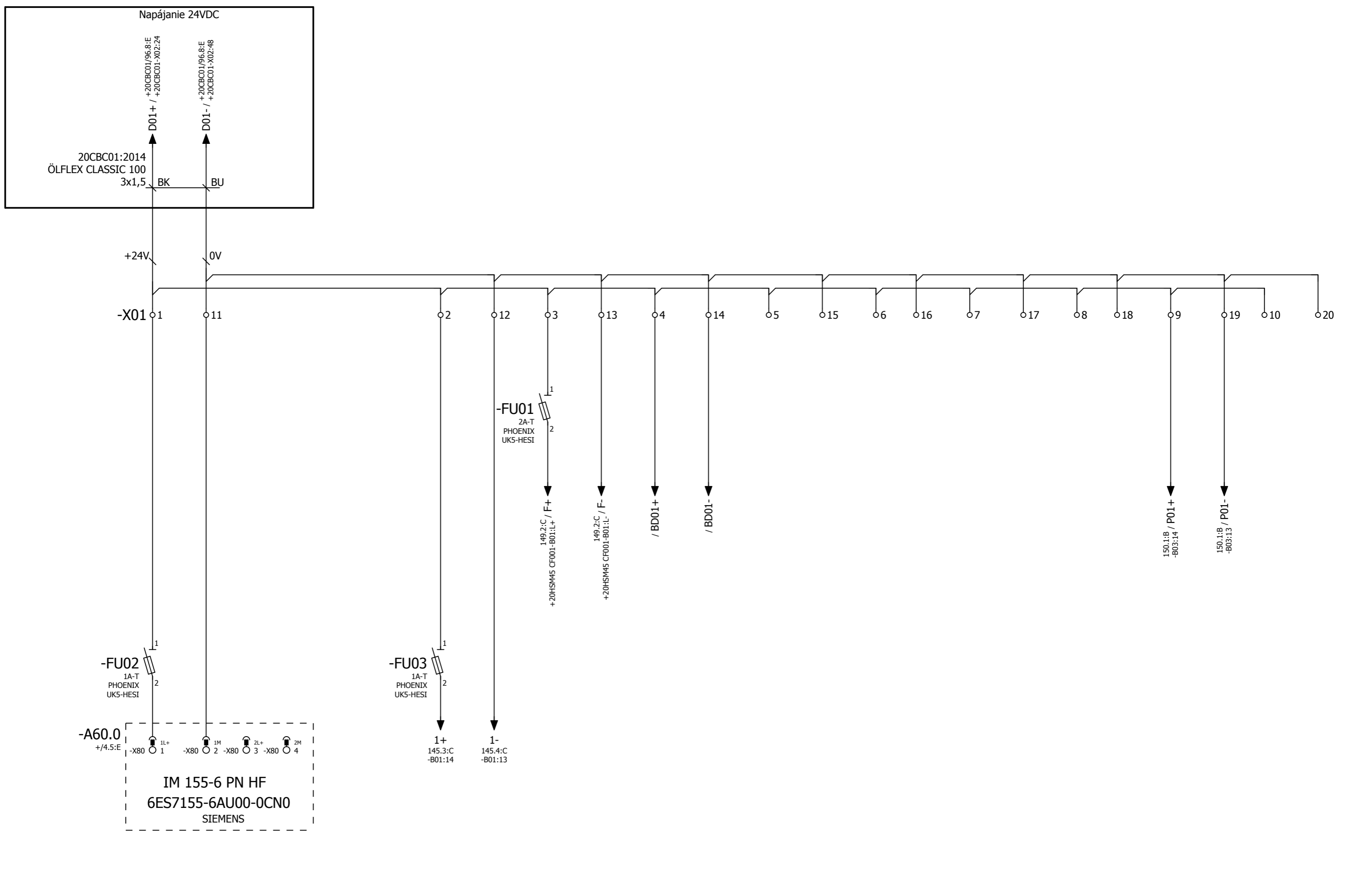

			Vypracoval	Tomáš Sivok
			Kontroloval	Began
			Schválil	Began
Revízia	Dátum	Meno	Datum	6/2016

Zákazník:	Odvoz a likvidácia odpadu a.s.
Zákazka:	Riadenie rošta

**SIEMENS**  
 SIEMENS s.r.o. ,Lamačská cesta 3/A  
 841 04 Bratislava - SK

**Rozvádzač SNCR**  
  
**Napájanie 24V DC**

	=
REV: 6/2016 PSV	+20CBD01
Arch. číslo: P.02091.01	List 144
	Listov 8

-A60.1  
/146.1:A  
Rack X  
Slot Y

6ES7131-6BF00-0BA0 + BU15-P16+A10+2D DI 8x24 VDC ST

SIEMENS

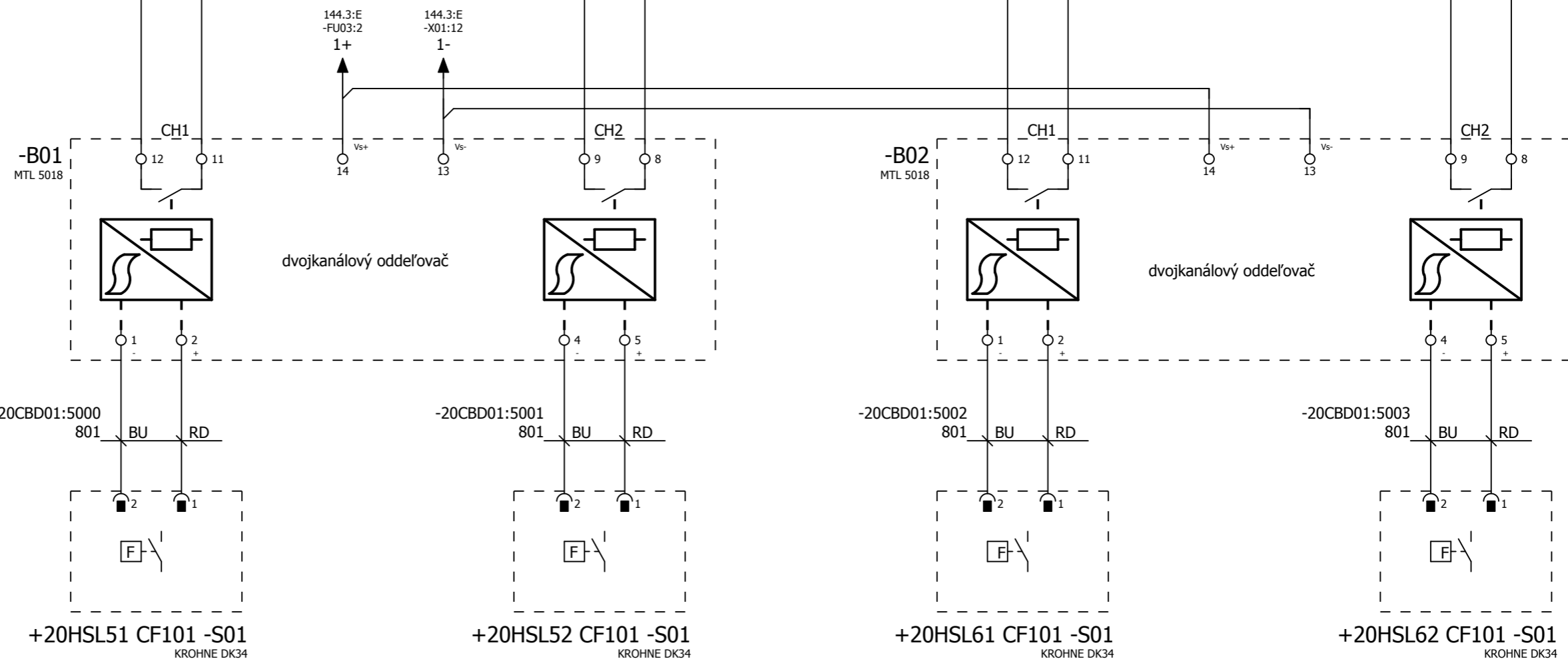
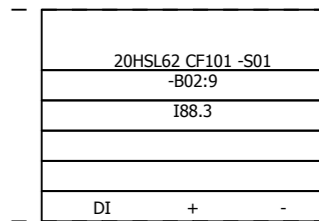
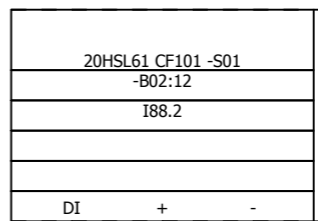
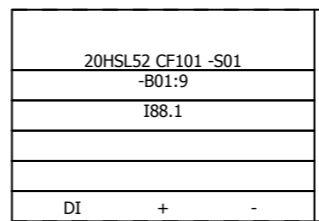
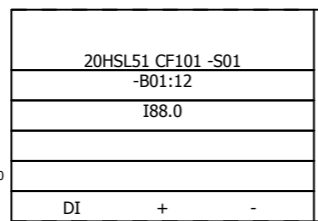
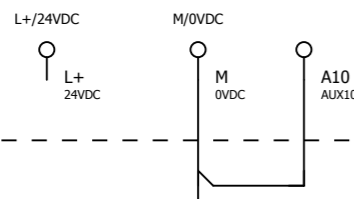

© Copyright SIEMENS s.r.o. 2015

Revízia	Dátum	Meno	Datum
			6/2016

Vypracoval Tomáš Sivok Kontroloval Began Schválil Began	Zákazník: Odvoz a likvidácia odpadu a.s. Zákazka: Riadenie rošta
---	---

**SIEMENS**  
SIEMENS s.r.o. „Lamačská cesta 3/A  
841 04 Bratislava - SK

**Rozvádzač SNCR**  
**DI karta 1-4**

REV: 6/2016 PSV	=
Arch. číslo: P.02091.01	+20CBD01
	List 145
	Listov 8

-A60.1  
/145.1:A  
Rack X  
Slot Y

6ES7131-6BF00-0BA0 + BU15-P16+A10+2D DI 8x24 VDC ST

SIEMENS

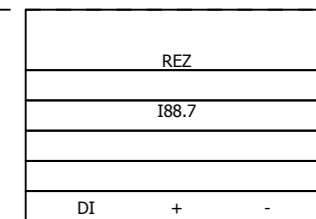
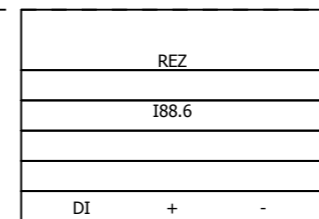
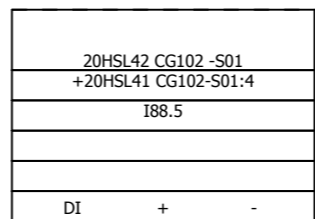
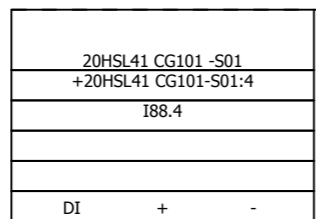

5 13 A5

6 14 A6

7 15 A7

8 16 A8

-20CBD01:5004  
801 GY BU RD

-20CBD01:5005  
801 GY BU RD

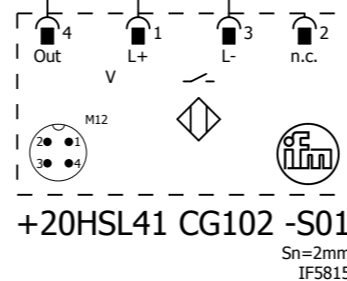
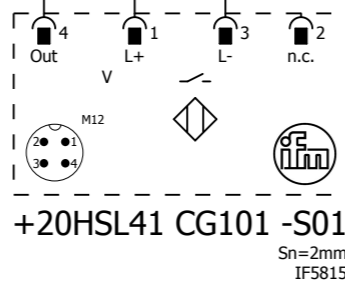

© Copyright SIEMENS s.r.o. 2015

			Vypracoval Tomáš Sivok
			Kontroloval Began
			Schválil Began
Revizia	Dátum	Meno	Datum 6/2016

Zákazník: Odvoz a likvidácia odpadu a.s.
Zákazka: Riadenie rošta

**SIEMENS**  
SIEMENS s.r.o. ,Lamačská cesta 3/A  
841 04 Bratislava - SK

**Rozvádzač SNCR**  
  
**DI karta 5-8**

		=
	REV: 6/2016 PSV	+20CBD01
	Arch. číslo: P.02091.01	List 146
		Listov 8

-A60.2  
/148.1:A  
Rack X  
Slot Y

6ES7132-6BF00-0BA0 + BU15-P16+A0+2B DQ 8x24 VDC/0,5A ST

SIEMENS

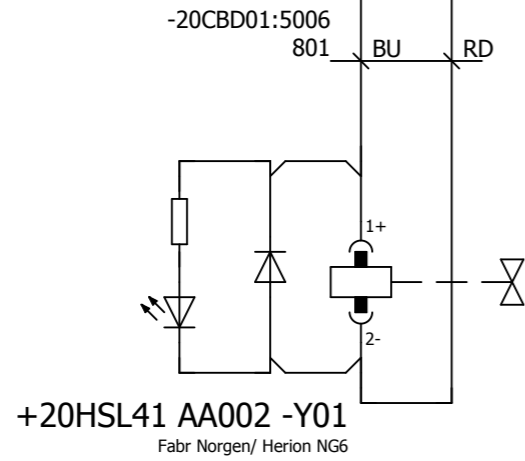
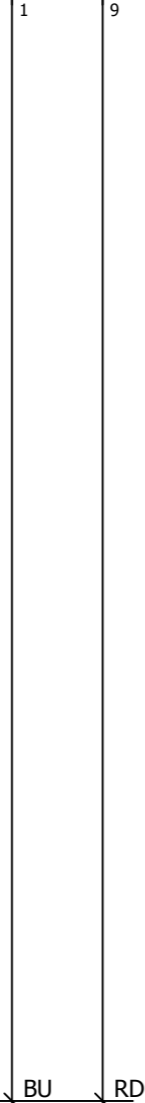
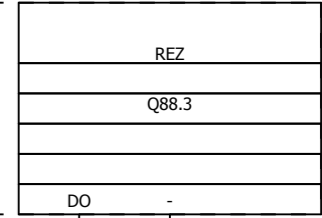
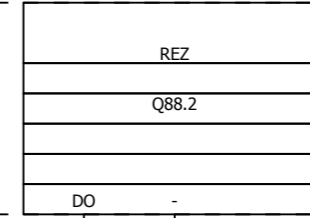
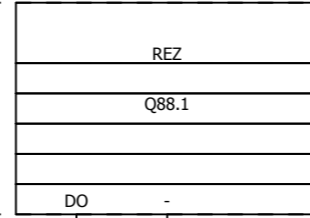
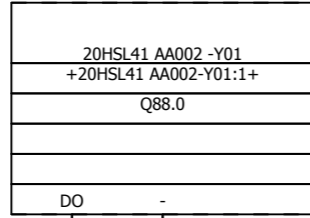

© Copyright SIEMENS s.r.o. 2015

			Vypracoval Tomáš Sivok
			Kontroloval Began
			Schválil Began
Revizia	Dátum	Meno	Datum 6/2016

Zákazník: Odvoz a likvidácia odpadu a.s.
Zákazka: Riadenie rošta

**SIEMENS**  
SIEMENS s.r.o. ,Lamačská cesta 3/A  
841 04 Bratislava - SK

**Rozvádzač SNCR**  
  
**4DO karta**

		=
REV: 6/2016 PSV		+20CBD01
Arch. číslo: P.02091.01		List 147
		Listov 8



-A60.2  
/147.1:A  
Rack X  
Slot Y

6ES7132-6BF00-0BA0 + BU15-P16+A0+2B DQ 8x24 VDC/0,5A ST

SIEMENS

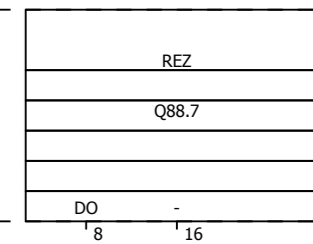
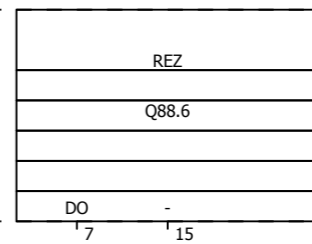
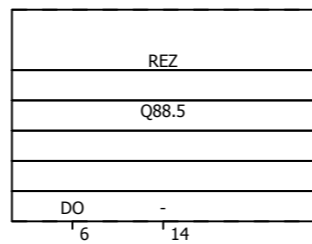
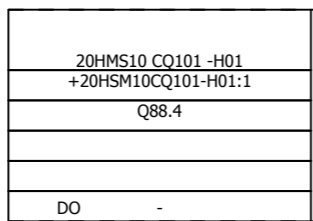

-20HSM10GH001:6000  
801 BU RD

=+20HSM10CQ101-H01

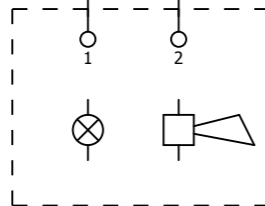

© Copyright SIEMENS s.r.o. 2015

			Vypracoval Tomáš Sivok
			Kontroloval Began
			Schválil Began
Revizia	Dátum	Meno	Datum 6/2016

Zákazník:	Odvoz a likvidácia odpadu a.s.
Zákazka:	<b>Riadenie rošta</b>

**SIEMENS**  
SIEMENS s.r.o. , Lamačská cesta 3/A  
841 04 Bratislava - SK

**Rozvádzač SNCR**  
  
**4DO karta**

	=
REV: 6/2016 PSV	+20CBD01
Arch. číslo: P.02091.01	List 148
	Listov 8

-A60.3  
Rack X  
Slot Y

6ES7134-6GD00-0BA1 + BU15-P16+A0+2B

AI 4xI 2-/4-wire ST

SIEMENS

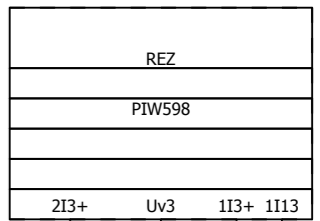
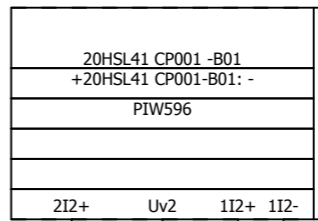
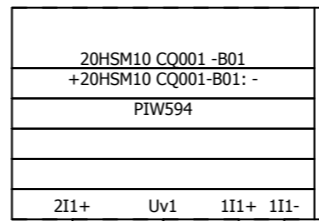
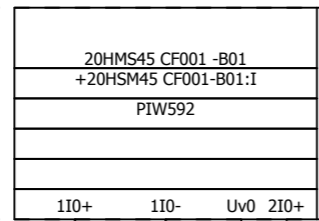
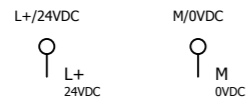

-TE

-TE

-TE

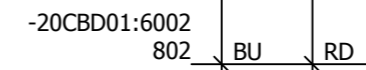
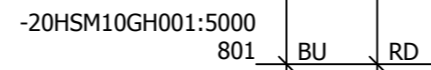
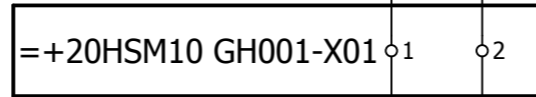
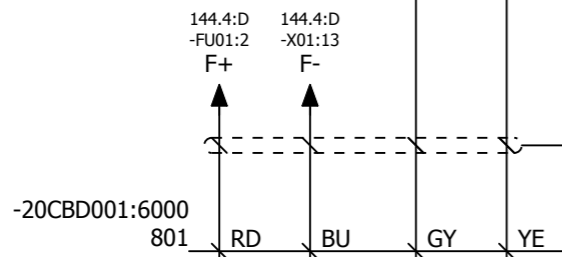

+20HSM45 CF001 -B01  
4-20mA  
Krohne IFM 5010  
Prietok NH4OH

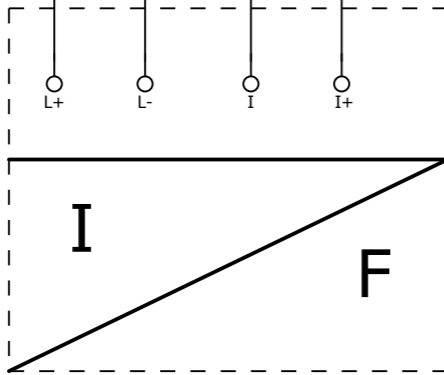

+20HSM10 CQ001 -B01  
4-20mA  
Fabr. Winter TAMS 1000  
Koncentrácia NH3 v rozdeľovači NH4OH

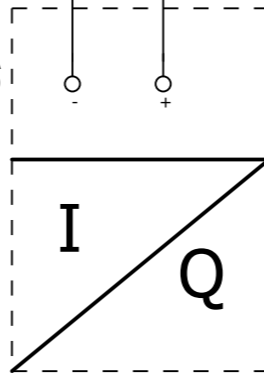

+20HSL41 CP001 -B01  
4-20mA  
PMS P40  
Tlak VE vody za regulátorom

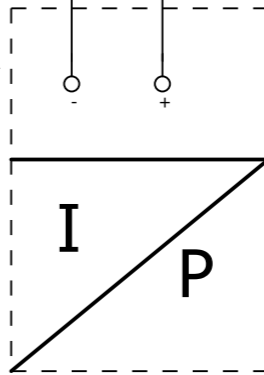

© Copyright SIEMENS s.r.o. 2015

Revizia	Dátum	Meno	Datum
1	2	3	4

Vypracoval	Tomáš Sivok	Zákazník:	Odvoz a likvidácia odpadu a.s.
Kontroloval	Began	Zákazka:	Riadenie rošta
Schválil	Began		
Datum	6/2016		

**SIEMENS**  
SIEMENS s.r.o. ,Lamačská cesta 3/A  
841 04 Bratislava - SK

**Rozvádzač SNCR**  
**AI karta**

REV: 6/2016 PSV	=
Arch. číslo: P.02091.01	+20CBD01
	List 149
	Listov 8

-A60.4  
/151.1:A  
Rack X  
Slot Y

6ES7131-6BF00-0BA0 + BU15-P16+A10+2D DI 8x24 VDC ST

SIEMENS

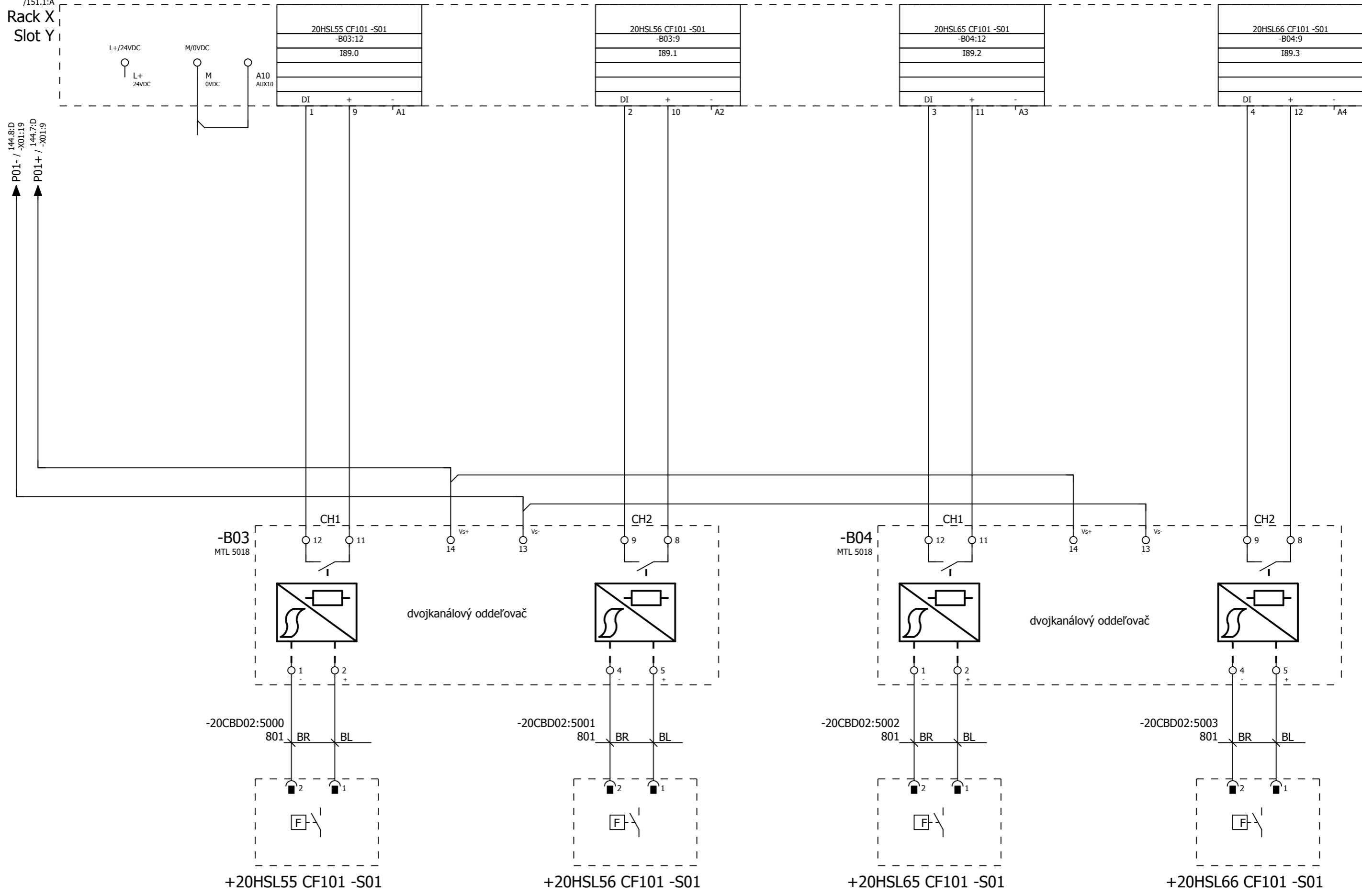

© Copyright SIEMENS s.r.o. 2015

Revizia	Dátum	Meno	Datum
			6/2016

Vypracoval Tomáš Sivok Kontroloval Began Schválil Began	Zákazník: Odvoz a likvidácia odpadu a.s. Zákazka: Riešenie rošťa
---	---

**SIEMENS**  
SIEMENS s.r.o. „Lamačská cesta 3/A  
841 04 Bratislava - SK

**Rozvádzač SNCR**  
**DI karta 1-4**

REV: 6/2016 PSV	=
Arch. číslo: P.02091.01	+20CBD01
	List 150
	Listov 8

-A60.4  
/150.1:A  
Rack X  
Slot Y

6ES7131-6BF00-0BA0 + BU15-P16+A10+2D DI 8x24 VDC ST

SIEMENS

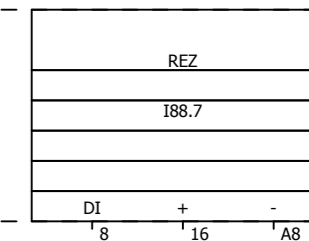
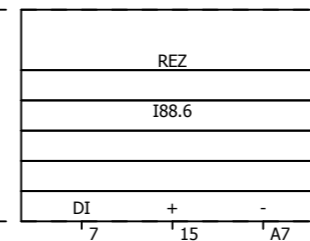
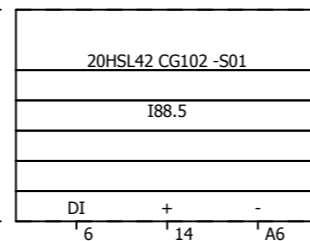
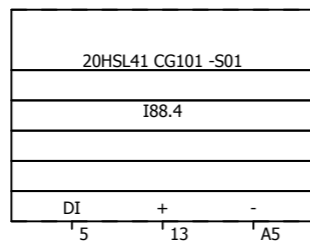

© Copyright SIEMENS s.r.o. 2015

A  
B  
C  
D  
E  
F

A  
B  
C  
D  
E  
F

			Vypracoval Tomáš Sivok
			Kontroloval Began
			Schválil Began
Revizia	Dátum	Meno	Datum 6/2016

Zákazník:	Odvoz a likvidácia odpadu a.s.
Zákazka:	<b>Riadenie rošta</b>

**SIEMENS**  
SIEMENS s.r.o. ,Lamačská cesta 3/A  
841 04 Bratislava - SK

**Rozvádzač SNCR**  
  
**DI karta 5-8**

		=
REV: 6/2016 PSV		+20CBD01
Arch. číslo: P.02091.01		List 151
		Listov 8