

REZ r11-r11
 M 1:100

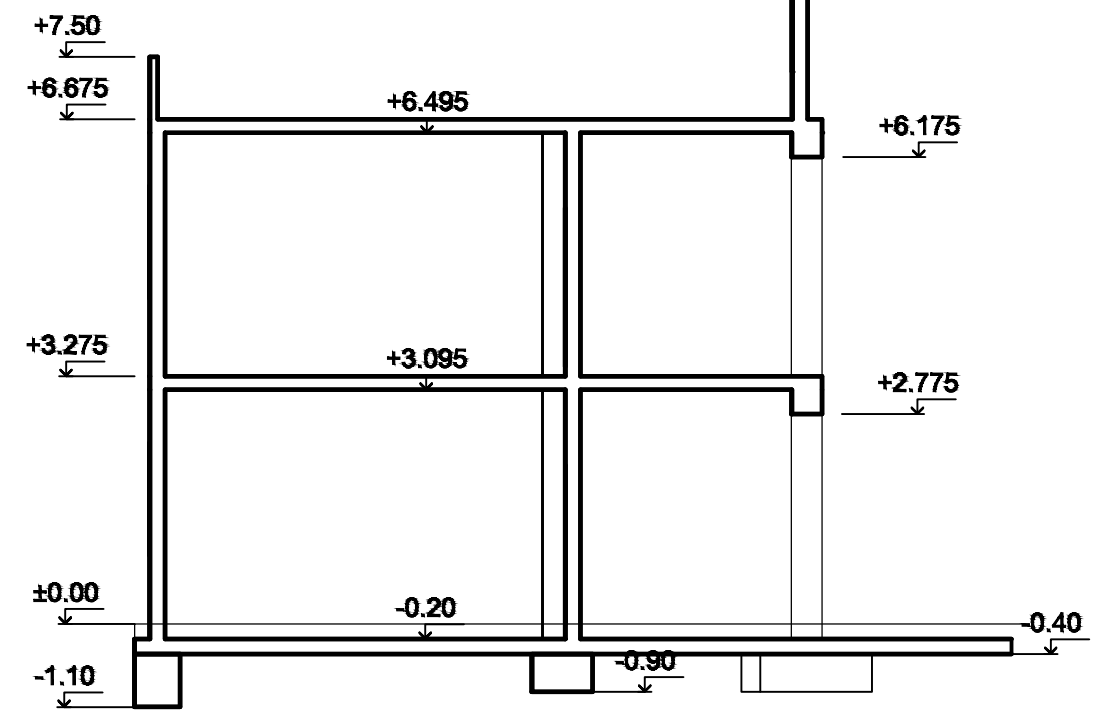

REZ r11a-r11a
 M 1:100

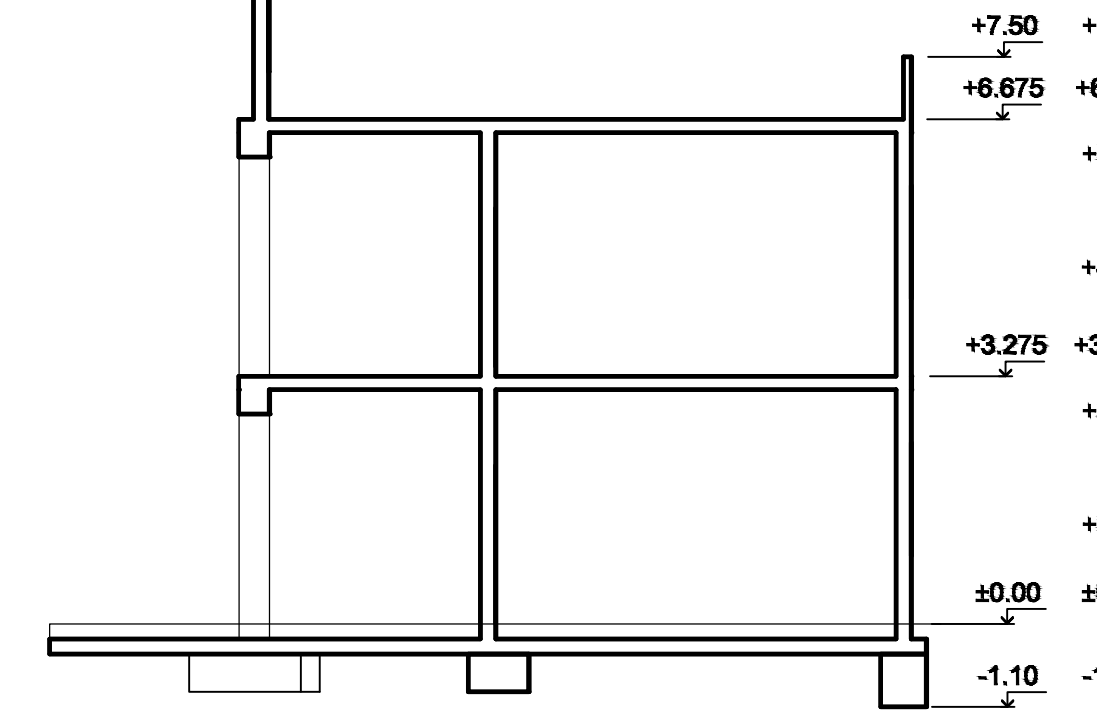

REZ r14-r14
 M 1:100

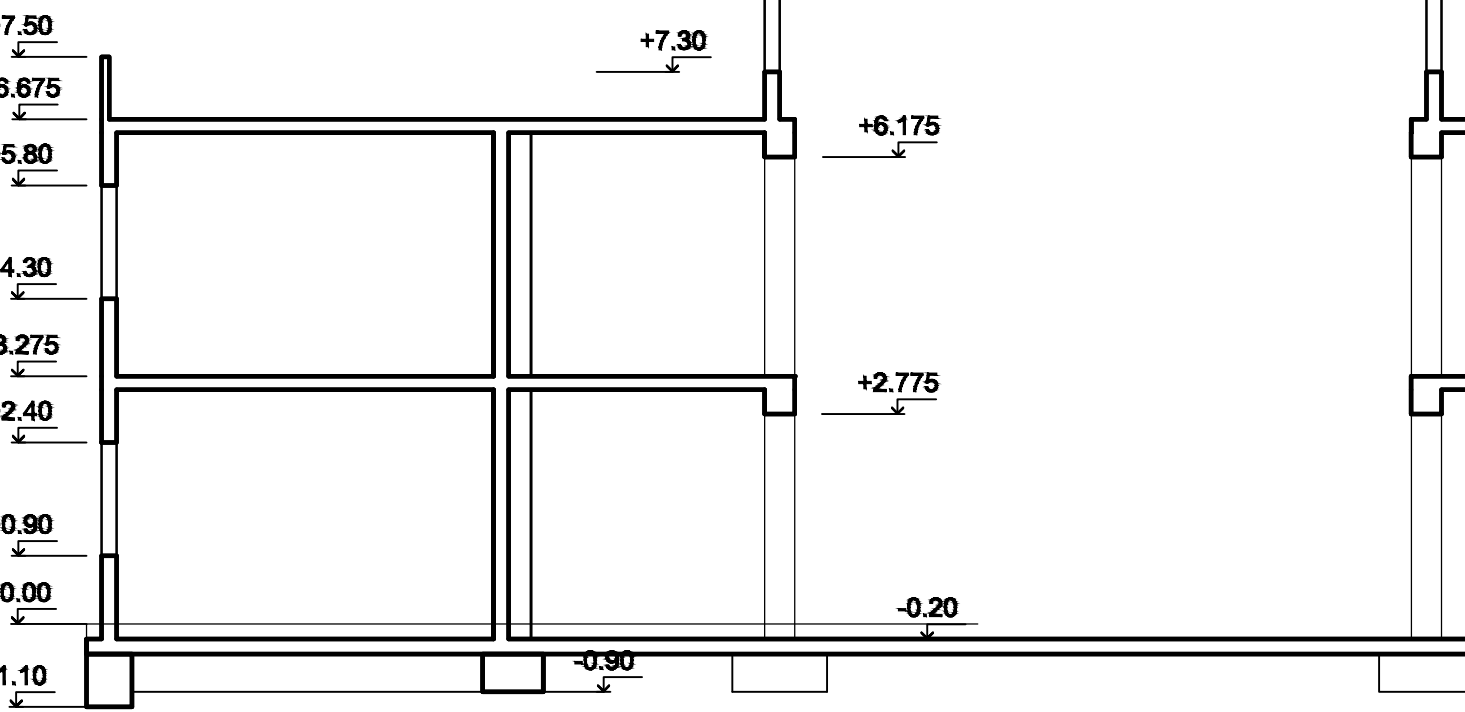

REZ r20-r20
 M 1:100

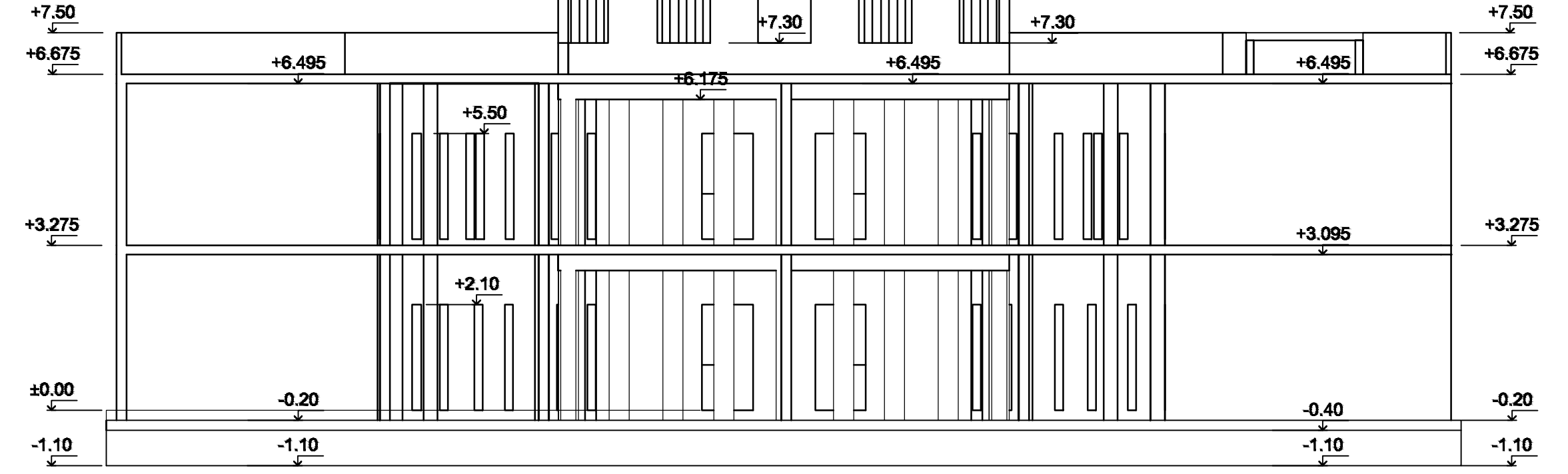

REZ r12-r12
 M 1:100

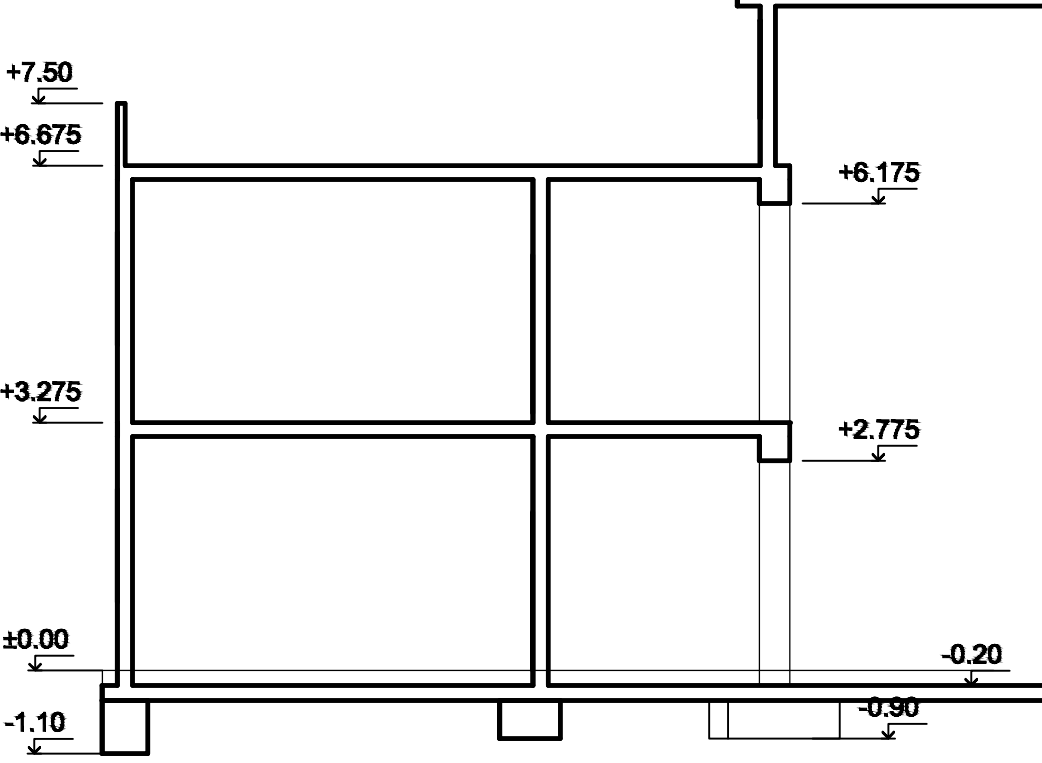

REZ r12a-r12a
 M 1:100

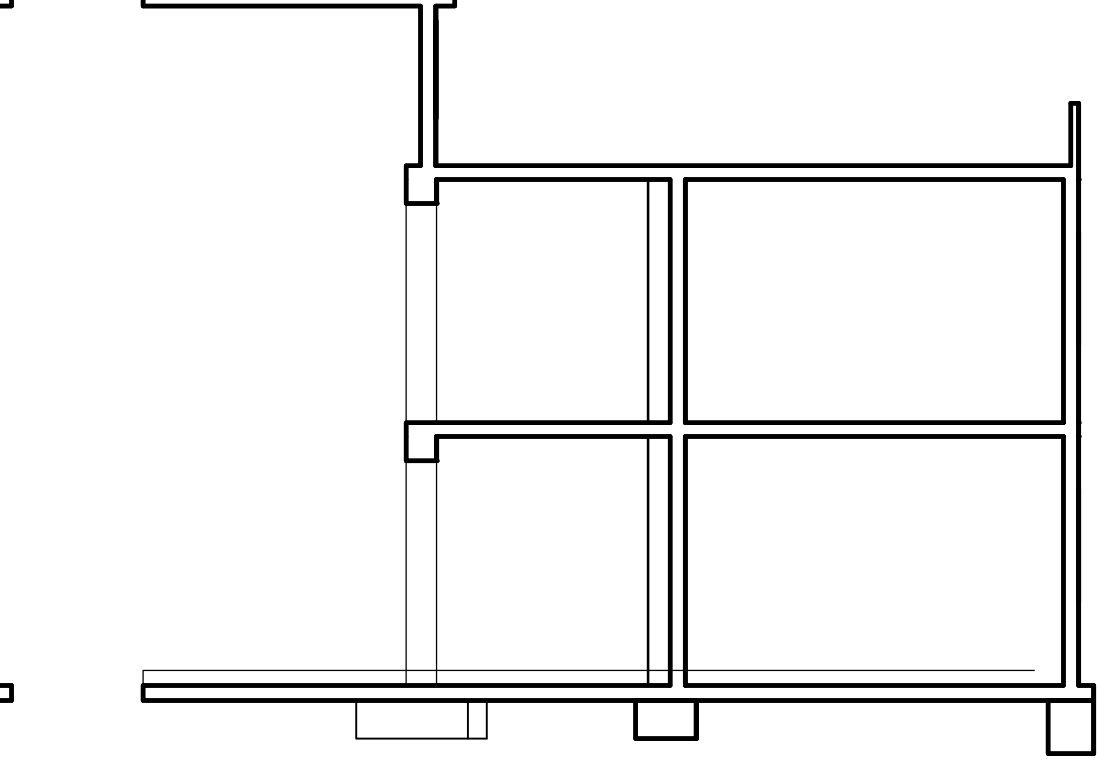

REZ r19-r19
 M 1:100

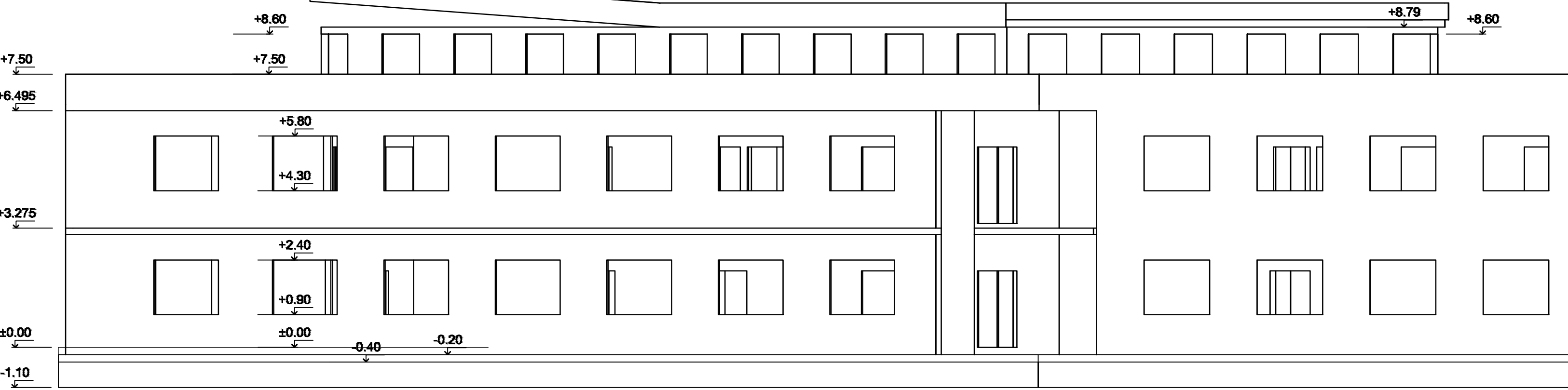

REZ r13-r13
 M 1:100

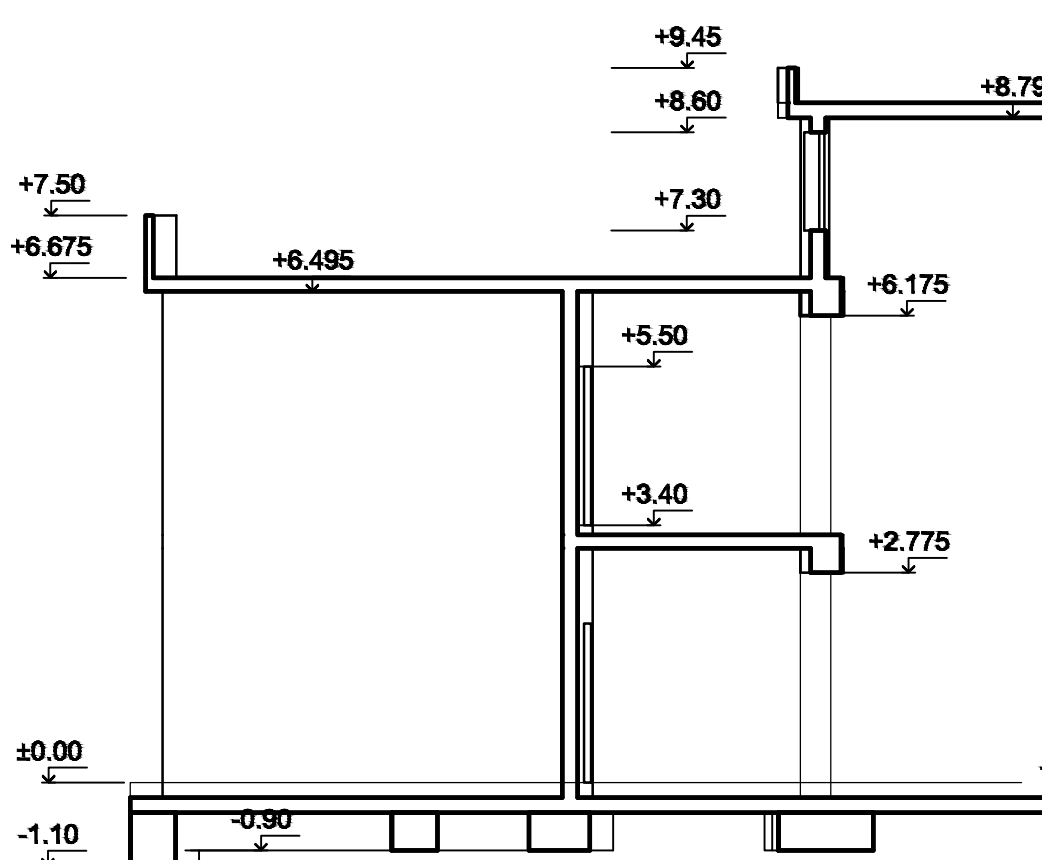

REZ r13a-r13a
 M 1:100

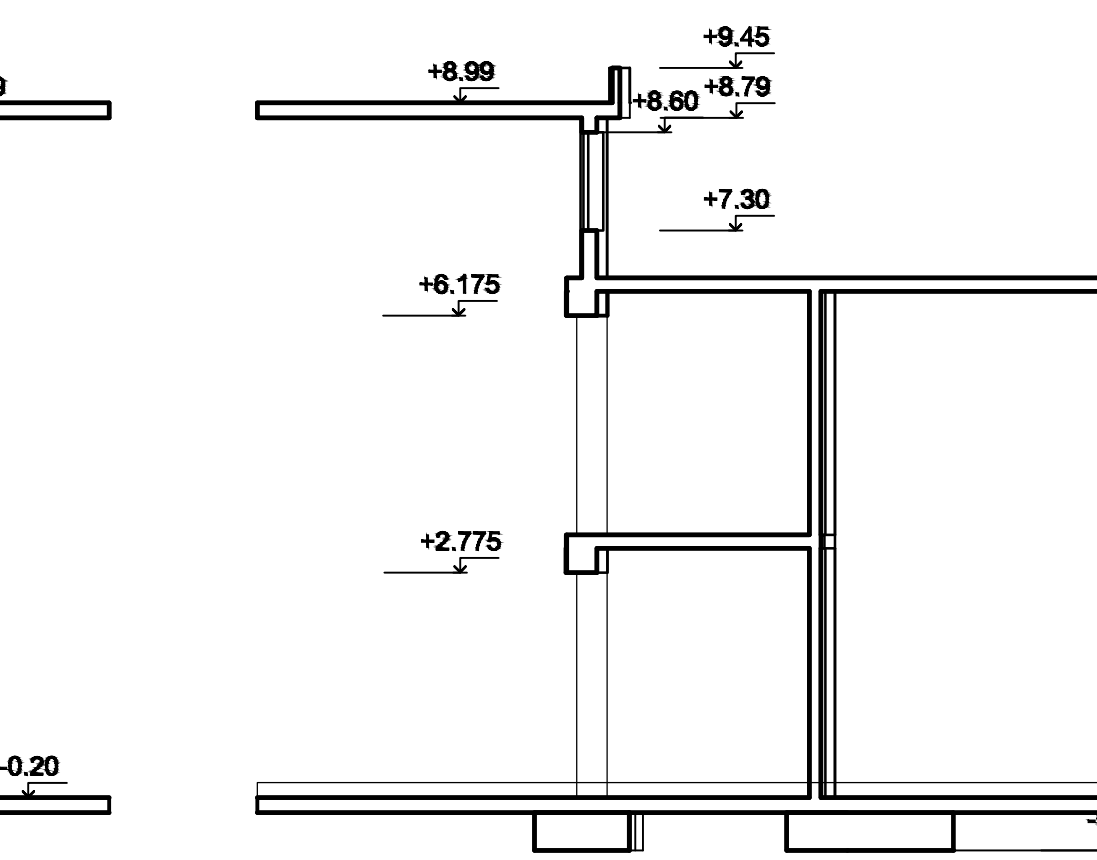

REZ r21-r21
 M 1:100

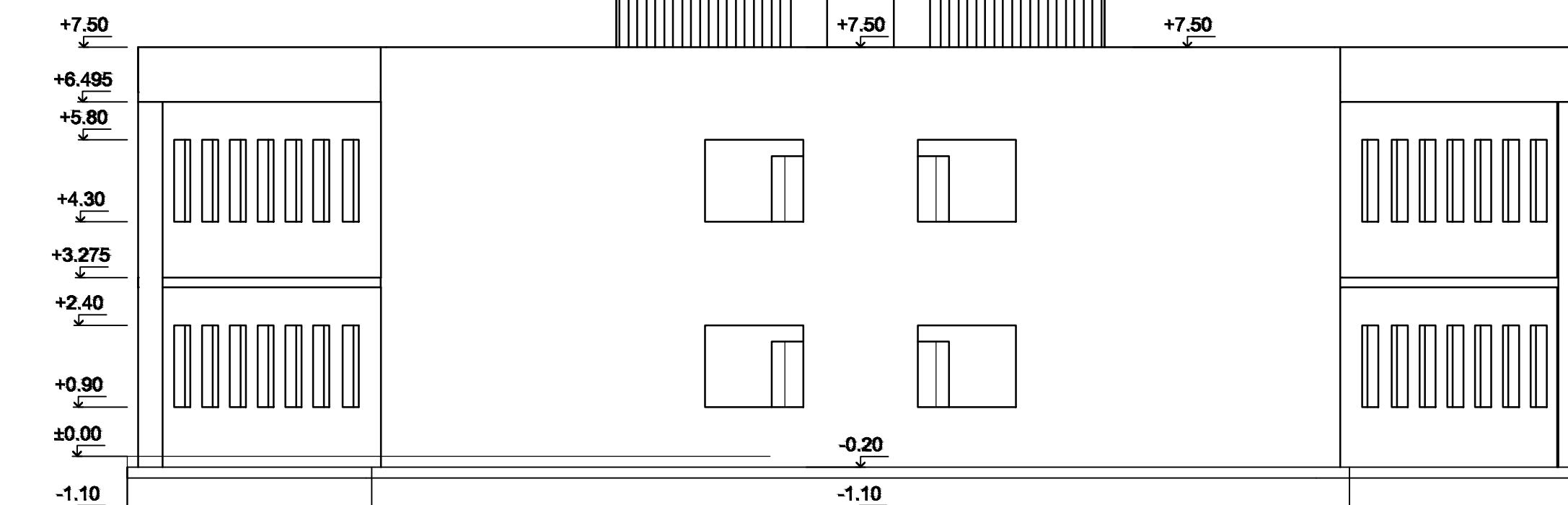

REZ r18-r18
 M 1:100

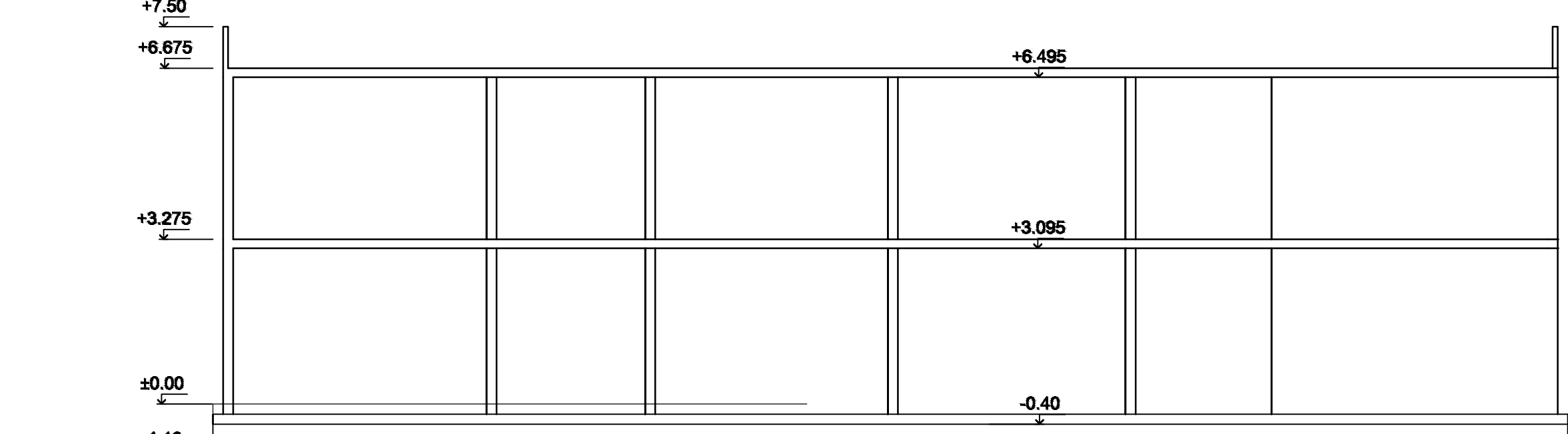

REZ r15-r15
 M 1:100

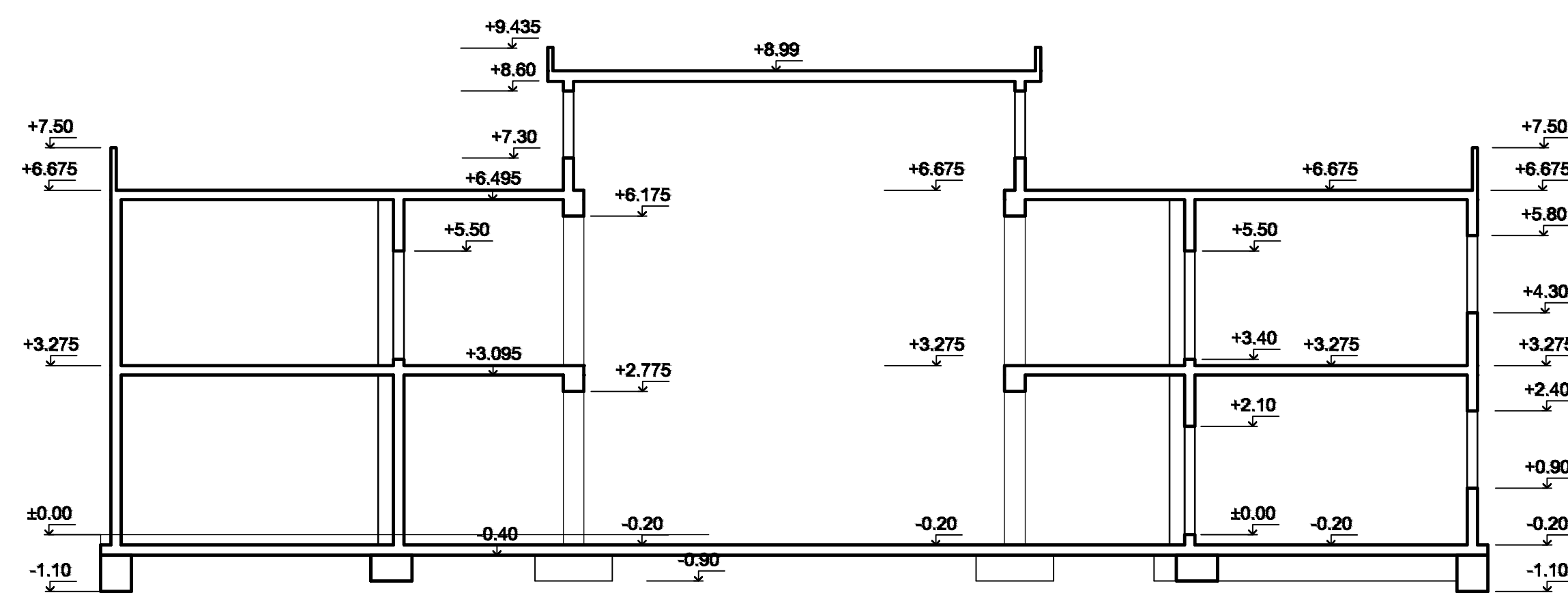

REZ r16-r16
 M 1:100

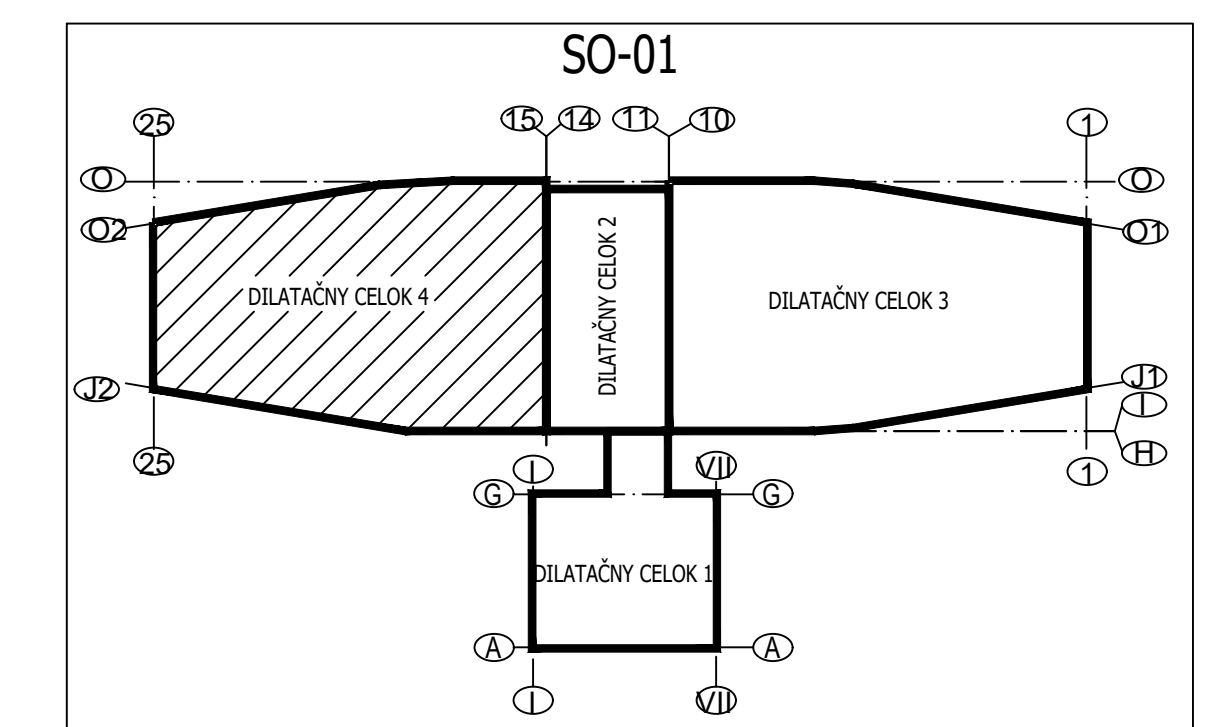
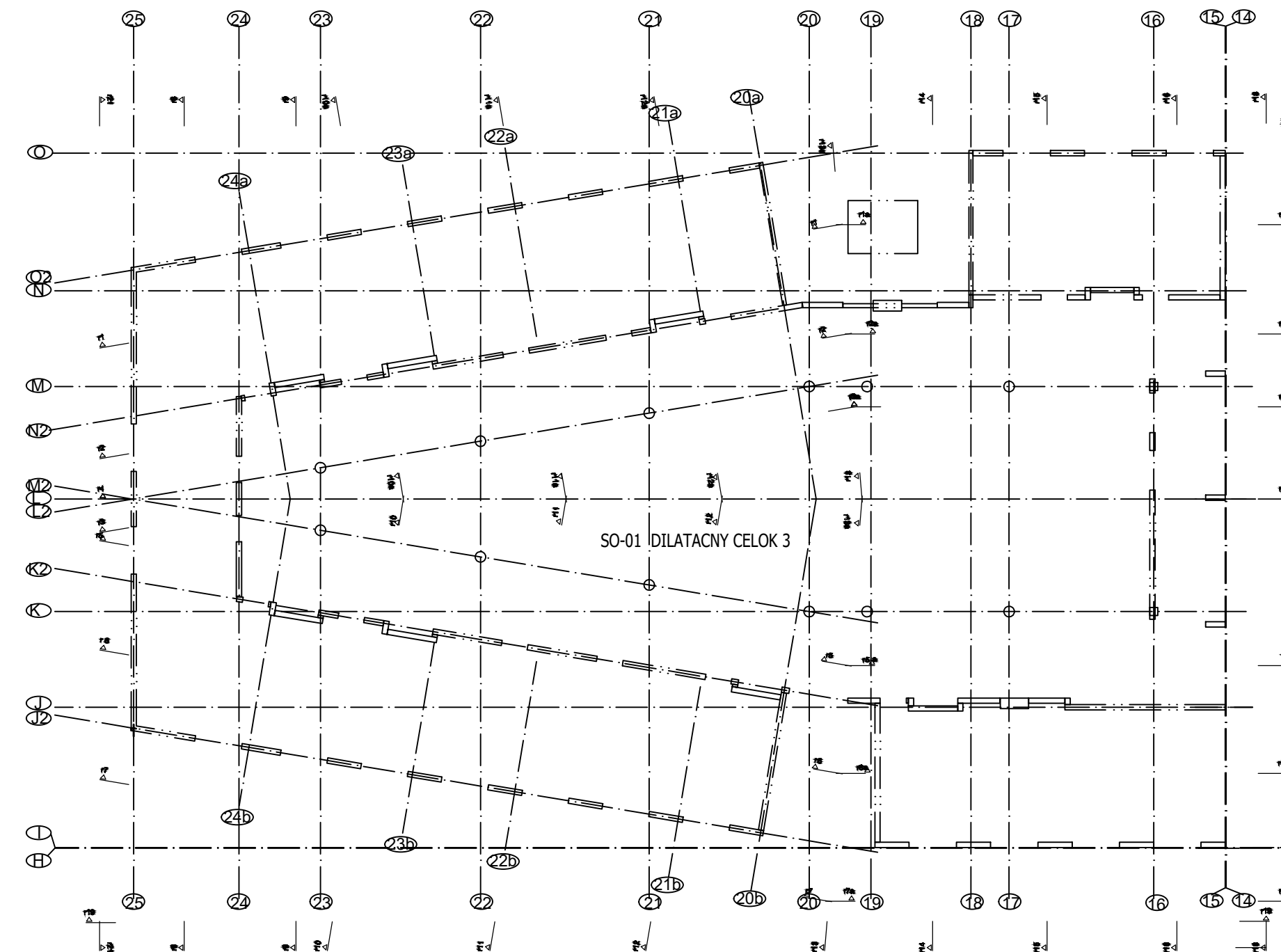
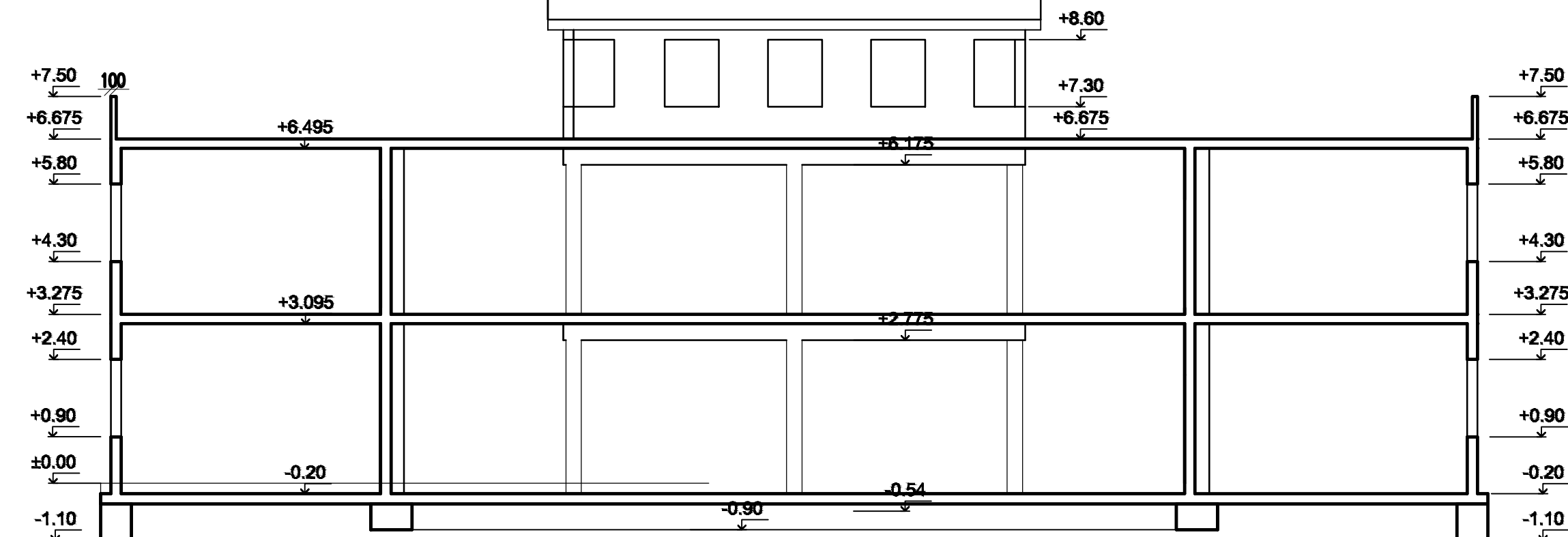

SO-01 DILATAČNY CELOK 3
 REZY R1,2, 3, 4, 5, 6, 8, 9, 10, 11

SO-01	AUTOR: Ing. Jozef Gónos	SOPOVEDENÝ: Ing. Jozef Gónos
DATEM: 07.11.2011	VYPRACOVANÝ: ING. HASSAN AL-HUSEIN P.H.B.	PROJEKTANT:
STAVBA:	INŠT. ENKA AL-HUSEINOVIA	
INVESTOR: MINISTERSTVO ZDRAVOTNÍCTVA SR	MESTO STAVBY: Bratislava, I. zóna, č. 1, 2011, 2012, 2013, 2014, 2015, 2016, 2017, 2018, 2019, 2020, 2021, 2022, 2023, 2024, 2025, 2026, 2027, 2028, 2029, 2030, 2031, 2032, 2033, 2034, 2035, 2036, 2037, 2038, 2039, 2040, 2041, 2042, 2043, 2044, 2045, 2046, 2047, 2048, 2049, 2050, 2051, 2052, 2053, 2054, 2055, 2056, 2057, 2058, 2059, 2060, 2061, 2062, 2063, 2064, 2065, 2066, 2067, 2068, 2069, 2070, 2071, 2072, 2073, 2074, 2075, 2076, 2077, 2078, 2079, 2080, 2081, 2082, 2083, 2084, 2085, 2086, 2087, 2088, 2089, 2090, 2091, 2092, 2093, 2094, 2095, 2096, 2097, 2098, 2099, 2100	FORMA: STUPEN' POC' DATUM: 04.2019
OBJEKT: SO 01 - DETENČNÝ ÚSTAV	LIŠTBOVÝ 5, 637 52 Bratislava	STAVBA: STAVBA
MAŠTĎ: VÝKRES TĚŽKÝ REZY REZY R11-R21	MIEŠKA: 1:100	ŠČ: G-10 2

Tendrová dokumentácia slúži pre výber zhotoviteľa a neslúži na realizáciu stavby!!!
 Jednotlivé položky vo výkaze výmer a rozpočte sa môžu líšiť po dopracovaní realizačného projektu!!!